



Installation Guide

Firefighter Gateway

with SetApp Configuration

Version 1.4

Contents

Disclaimers	4
Important Notice	4
Emission Compliance	4
Support and Contact Information	6
Revision History	7
HANDLING AND SAFETY INSTRUCTIONS	8
Safety Symbols Information	8
About This Guide	9
Chapter 1: Introducing the SolarEdge Firefighter Gateway	10
Overview	10
Firefighter Gateway Interfaces	11
LCD and LCD-Menu Buttons	12
Communication Connectors	12
LEDs	13
Other Interfaces	13
Chapter 2: Installing the Firefighter Gateway	14
Transport and Storage	14
Package Contents	14
Installation Equipment	14
Installation Guidelines	14
Installation Workflow	15
Mounting and Connecting the Firefighter Gateway	16
Connecting the Firefighter Gateway to AC	17
Chapter 3: Connecting the Firefighter Gateway to the Installation	18
Overview	18
Creating an RS485 Bus Connection	18
Verifying the Connection	23
Troubleshooting the RS485 Communication	24
Creating an Ethernet (LAN) Connection	24
Verifying the Connection	27
Additional Connection Options	28
Chapter 4: LCD – Status Screens and Setup Options	29
Status Screens - Operational Mode	29
Configuration Menu Options	33
Chapter 5: Emergency System Shutdown	39
Chapter 6: Setting Up Monitoring through the Firefighter Gateway (Optional)	42
Communication Dataflow	42

Communication Options	42
Creating an Ethernet (LAN) Connection	44
Appendix A: Mounting the ZigBee Plug-in in the Firefighter Gateway	48
Appendix B: Connecting Emergency Stop Button or Fire Alarm Control	49
Overview	49
Connecting and Configuring an Emergency Stop Button to the Gateway	51
Appendix C: Inserting the GSM Modem in the Firefighter Gateway	54
Appendix D: Errors and Troubleshooting	56
Troubleshooting Communication	56
Appendix E: Mechanical Specifications	59
Firefighter Gateway Technical Specifications	60

Disclaimers

Important Notice

Copyright © SolarEdge Inc. All rights reserved.

No part of this document may be reproduced, stored in a retrieval system or transmitted, in any form or by any means, electronic, mechanical, photographic, magnetic or otherwise, without the prior written permission of SolarEdge Inc.

The material furnished in this document is believed to be accurate and reliable. However, SolarEdge assumes no responsibility for the use of this material. SolarEdge reserves the right to make changes to the material at any time and without notice. You may refer to the SolarEdge web site (www.solaredge.com) for the most updated version.

All company and brand products and service names are trademarks or registered trademarks of their respective holders.

Patent marking notice: see <http://www.solaredge.com/patent>

The general terms and conditions of delivery of SolarEdge shall apply.

The content of these documents is continually reviewed and amended, where necessary. However, discrepancies cannot be excluded. No guarantee is made for the completeness of these documents.

Please note: This product is intended to provide remote shutdown of the SolarEdge PV harvesting system, to enable safer access to a building in the event of fire. This product DOES NOT reduce the risk of fire or protect firefighters or others accessing a building in the event of a fire.

If the RS485 communication between the firefighter gateway and the SolarEdge inverter(s) is disconnected for any reason (including fire), the firefighter gateway LCD will display "No Communication" or "Partial Com.". In this case, the firefighter gateway cannot be relied upon to disconnect the SolarEdge PV harvesting system.

The images contained in this document are for illustrative purposes only and may vary depending on product models.

Emission Compliance

This equipment has been tested and found to comply with the limits applied by the local regulations.

These limits are designed to provide reasonable protection against harmful interference in a residential installation. This equipment generates, uses and can radiate radio frequency energy and, if not installed and used in accordance with the instructions, may cause harmful interference to radio communications. However, there is no

guarantee that interference will not occur in a particular installation. If this equipment does cause harmful interference to radio or television reception, which can be determined by turning the equipment off and on, you are encouraged to try to correct the interference by one or more of the following measures:

- Reorient or relocate the receiving antenna.
- Increase the separation between the equipment and the receiver.
- Connect the equipment into an outlet on a circuit different from that to which the receiver is connected.
- Consult the dealer or an experienced radio/TV technician for help.

Changes or modifications not expressly approved by the party responsible for compliance may void the user's authority to operate the equipment.

Support and Contact Information

If you have technical problems concerning SolarEdge products, please contact us:

Support Center: <https://www.solaredge.com/service/support>

Country	Phone	E-Mail
Australia (+61)	1800 465 567	support@solaredge.net.au
APAC (Asia Pacific)(+972)	073 240 3118	support-asia@solaredge.com
Belgium (+32)	0800-76633	support@solaredge.be
China (+86)	21 6212 5536	support_china@solaredge.com
DACH & Rest of Europe (+49)	089 454 59730	support@solaredge.de
France (+33)	0800 917410	support@solaredge.fr
Italy (+39)	0422 053700	support@solaredge.it
Japan (+81)	03 6262 1223	support@solaredge.jp
Netherlands (+31)	0800 7105	support@solaredge.nl
New Zealand (+64)	0800 144 875	support@solaredge.net.au
Republic of Ireland (+353)	1800 901 575	support-uk@solaredge.com
United Kingdom (+44)	0800 028 1183	
US & Canada (+1)	510 498 3200	ussupport@solaredge.com
Greece (+49)	89 454 59730	support@solaredge.com
Israel (+972)	073 240 3122	
Middle East & Africa (+972)	073 240 3118	
South Africa (+27)	0800 982 659	
Turkey (+90)	216 706 1929	
Worldwide (+972)	073 240 3118	

Before contact, make sure to have the following information at hand:

- Model and serial number of the product in question.
- The error indicated on the Inverter LCD screen or on the monitoring platform or by the LEDs, if there is such an indication.
- System configuration information, including the type and number of modules connected and the number and length of strings.
- The communication method to the SolarEdge server, if the site is connected.
- The software version as appears in the ID status screen.

Revision History

Version 1.4 (March 2019)

- Removed mention of Safety and Monitoring Interfaces.
- Added a note about the he maximum length of the wire between the Firefighter Gateway and the stop button.

HANDLING AND SAFETY INSTRUCTIONS

During installation, testing and inspection, adherence to all the handling and safety instructions is mandatory. **Failure to do so may result in injury or loss of life and damage to the equipment.**

Safety Symbols Information

The following safety symbols are used in this document. Familiarize yourself with the symbols and their meaning before installing or operating the system.

WARNING!



Denotes a hazard. It calls attention to a procedure that, if not correctly performed or adhered to, could result in **injury or loss of life**. Do not proceed beyond a warning note until the indicated conditions are fully understood and met.

CAUTION!



Denotes a hazard. It calls attention to a procedure that, if not correctly performed or adhered to, could result in **damage or destruction of the product**. Do not proceed beyond a caution sign until the indicated conditions are fully understood and met.

NOTE



Denotes additional information about the current subject.

IMPORTANT SAFETY FEATURE



Denotes information about safety issues.

Disposal requirements under the Waste Electrical and Electronic Equipment (WEEE) regulations:

NOTE



Discard this product according to local regulations or send it back to SolarEdge.

About This Guide

This user guide is intended for Photovoltaic (PV) system owners, installers, technicians, maintainers and integrators who use the SolarEdge power harvesting system.

This guide describes the process of installing and configuring the SolarEdge firefighter gateway (also referred to as SolarEdge gateway).

This guide assumes that the SolarEdge power harvesting system is already installed and commissioned. For additional information about how to install and commission the SolarEdge power harvesting system, refer to the relevant inverter installation guide.

The guide includes the following chapters:

- Chapter 1: *Introducing the SolarEdge Firefighter Gateway* on page 10, describes the SolarEdge firefighter gateway.
- Chapter 2: *Installing the Firefighter Gateway* on page 14, describes how to install the SolarEdge firefighter gateway.
- Chapter 3: *Connecting the Firefighter Gateway to the Installation* on page 18
- Chapter 4: *LCD – Status Screens and Setup Options* on page 29
- Chapter 5: *Emergency System Shutdown* on page 39
- Chapter 6: *Setting Up Monitoring through the Firefighter Gateway (Optional)* on page 42, describes how to set up communication through the SolarEdge firefighter gateway to the SolarEdge monitoring platform.
- Appendix A: *Mounting the ZigBee Plug-in in the Firefighter Gateway* on page 48
- Appendix B: *Connecting Emergency Stop Button or Fire Alarm Control* on page 49.
- Appendix C: *Inserting the GSM Modem in the Firefighter Gateway* on page 54
- Appendix D: *Errors and Troubleshooting* on page 56
- Appendix E: *Mechanical Specifications* on page 59

For further information, datasheets and the most up-to-date certifications for various products in different countries, please visit the SolarEdge website: www.solaredge.com.

Chapter 1: Introducing the SolarEdge Firefighter Gateway

Overview

The firefighter gateway provides centralized safety management of SolarEdge systems: If the firefighter gateway is properly installed and fully functional, firefighters can halt production of a SolarEdge photovoltaic (PV) power harvesting system and have visual acknowledgment that the installation outputs a safe DC voltage. The power production can be stopped either manually through an emergency stop button or automatically through a Fire Alarm Control Panel system. This stops the AC production and reduces string DC voltage to a safe voltage using the unique SafeDC™ feature.

Although DC voltage can be reduced directly from the inverter or by shutting off the AC voltage, using the firefighter gateway provides a clear indication of DC voltage shutdown. The firefighter gateway enables shutting off the installation from a distance of up to 1,000m, while getting visual feedback that the PV installation is safe.

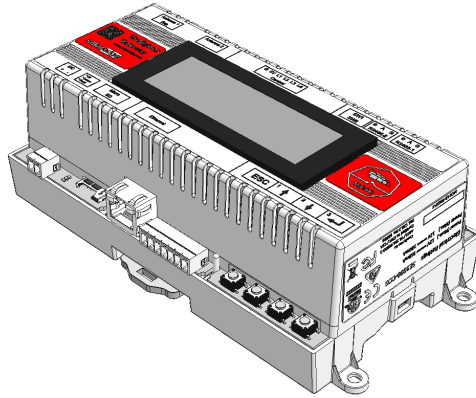

Figure 1: The SolarEdge Firefighter gateway

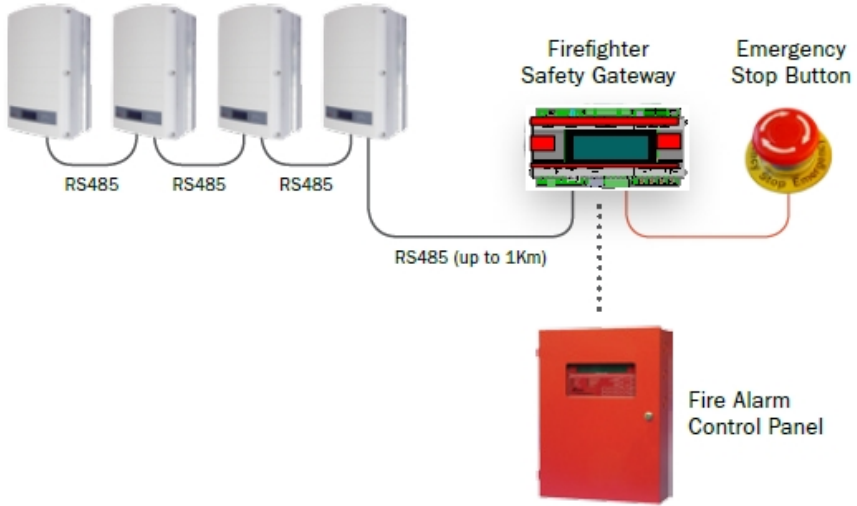

Figure 2: Example of SolarEdge firefighter gateway connections

Firefighter Gateway Interfaces

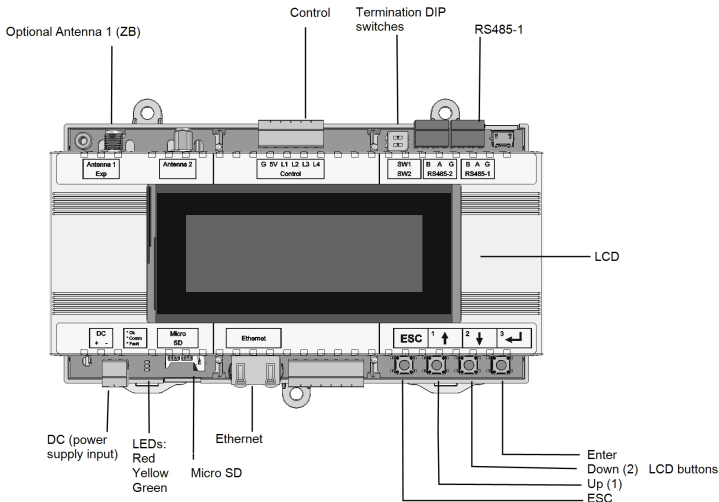

Figure 3: Firefighter gateway interfaces

LCD and LCD-Menu Buttons

The LCD screen displays status information of the system and various menus for configuration options. The LCD panel and buttons are used during the following processes:

- **Operational mode:** The LCD panel allows checking for proper system operation. Refer to *Status Screens - Operational Mode* on page 29 for a description of this option.
- **Setup mode:** Upon installation, an installer may perform basic configurations as described in *Configuration Menu Options* on page 33.
- **Error messages:** In the event of a problem, an error message may be displayed on the LCD panel.
For more information, refer to *Errors and Troubleshooting* on page 56.

Use the four user buttons to control the LCD panel menus:

- **Esc:** Moves the cursor (>) to the beginning of the currently displayed parameter; goes to the previous menu, and cancels a value change with a long press (until **Aborted** is displayed).
- **Up (1) and Down (2):** Moves the cursor from one menu option to another, moves among the characters of a displayed parameter, and toggles between possible characters when setting a value.
- **:** Selects a menu option and accepts a value change with a long press (until **Applied** is displayed).

Communication Connectors

- **Antenna1:** used for optional wireless ZigBee or Wi-Fi antenna connection (refer to *Additional Connection Options* on page 28).
- **RS485-1 and RS485-2:** used for connecting external devices to the gateway (refer to *Connecting the Firefighter Gateway to the Installation* on page 18).
- **Ethernet:** enables connecting the SolarEdge gateway to the SolarEdge monitoring platform through an Ethernet switch/router (refer to *Creating an Ethernet (LAN) Connection* on page 24). The Ethernet switch/router should be connected to the Internet.

LEDs

The Firefighter Gateway has three LED indicators, as follows:

- **OK (Green):** Indicates whether or not the Commercial gateway is powered.
- **Comm (Communication, Yellow):** Blinks when monitoring information is received from another SolarEdge device in the installation.
- **Fault (Red):** Indicates that there is an error. For more information, contact SolarEdge support.

All LEDs are ON while the Firefighter Gateway is being configured and during power up.

Other Interfaces

- **Control:** used for connection to an external emergency stop button (refer to *Connecting Emergency Stop Button or Fire Alarm Control* on page 49)

NOTE



The maximum length of the wire between the Firefighter Gateway and the stop button should be 2 meters / 6.5 ft.

- **DC:** used for the power supply input.
- **SW1:** RS485-1 termination
- **Micro SD:** used for field software upgrade
- **LEDs:** All LEDs are ON while the SolarEdge gateway is powered up or configured.

Chapter 2: Installing the Firefighter Gateway

Transport and Storage

Transport the gateway in its original packaging, without exposing it to unnecessary shocks. If the original package is no longer available, use a similar box, which can be closed fully.

Store the gateway in a dry place where ambient temperatures are -40°C (-40°F) to $+60^{\circ}\text{C}$ (140°F).

Package Contents

- Firefighter Gateway
- 100-240VAC to 12VDC (50 Hz/60 Hz) power supply with an interchangeable AC plug (US, EU, AU)
- Accessory kit including:
 - Three 3-pin terminal blocks
 - One 6-pin terminal block

Installation Equipment

Standard tools can be used during the installation of the Firefighter Gateway . The following is a recommendation of the equipment needed for installation:

- Emergency stop button (recommended: a button with a locking feature, which stays mechanically locked in the off position until turning it clockwise to release it), or a fire alarm control system with relay output interface
- DIN rails
- Drill and 4mm diameter bits
- Three twisted wires or four-wire twisted pair cable (wire cross-section area: 0.2- 1 mm²/ 24-18 AWG (a CAT5 cable may be used); Maximum nodes: 32; Maximum distance between devices: 1 km / 3300 ft.)
- For installing the communication options: CAT5/6 Ethernet cable

Installation Guidelines

The following requirements apply when locating and mounting the gateway:

- The gateway is suitable for mounting indoors only. For outdoor installation, use an external outdoor enclosure (not provided by SolarEdge)

- The gateway must always remain in an ambient temperature of -20°C (-4°F) to +60°C (140°F).
- The gateway power supply requires a socket outlet with a grid voltage of 100 V - 240 V (50/60Hz).
- Protect the gateway from dust, wet conditions, corrosive substances and vapors.
- Cable specifications:

Connection Type	Cable Type	Maximum Length
RS485 communication bus (per RS485 port)	Three twisted wires or 4-wire twisted pair cable (two twisted pairs). Recommended wire size: 20 AWG / 0.52 mm ²	1,000m (3,330 ft)
Ethernet	CAT5/6	100m (325 ft).

NOTE



If using a cable longer than 10 m/33 ft in areas where there is a risk of induced voltage surges by lightning, it is recommend to use external surge protection devices. For details refer to: http://www.solaredge.com/files/pdfs/lightning_surge_protection.pdf. If grounded metal conduit are used for routing the communication wires, there is no need for a lightning protection device.



Installation Workflow

The following provides an overview of the workflow for installing and setting up the Firefighter Gateway:

- [Mounting the Firefighter Gateway](#), page 16
- [Connecting the Firefighter Gateway to the SolarEdge installation](#), page 18
- [Configuring the Firefighter Gateway and inverters](#), page 18
- [Using the Firefighter Gateway to connect the installation to the monitoring server \(optional\)](#), page 18

Mounting and Connecting the Firefighter Gateway

The gateway can be installed on a wall or on a DIN rail.

→ To mount the Commercial Gateway on a wall:

1. Determine the mounting location. Leave clearance from all sides of the gateway for cover opening, cable connection and routing.
2. Position the device on the wall, mark points through the mounting tabs and drill holes using a 4mm diameter drill bit.
3. Mount the unit using screw anchors and screws (use 3.5mm diameter screws, 20mm minimum length, not provided by SolarEdge).

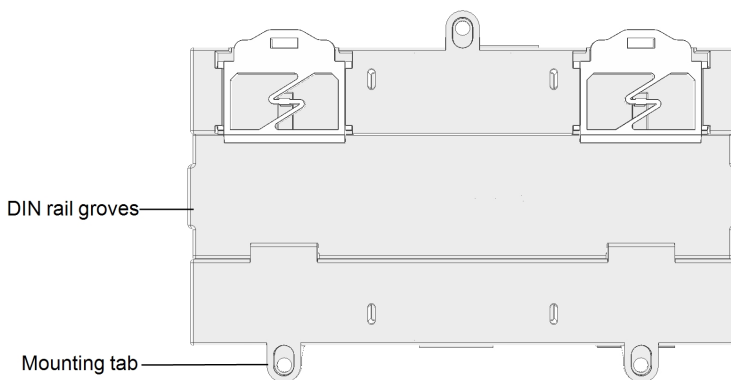

Figure 4: Firefighter Gateway mounting tabs

→ To mount the Commercial Gateway on a DIN rail:

1. Press the gateway upwards and snap it into the upper and lower edges of the DIN rail.

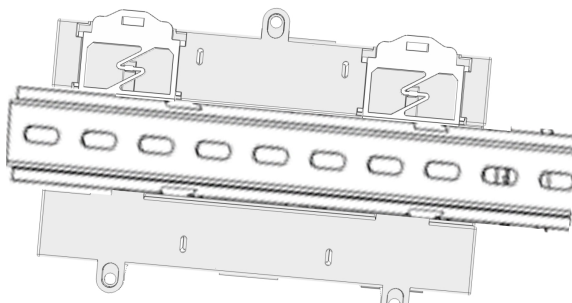

Figure 5: Firefighter Gateway mounted on a DIN rail

Connecting the Firefighter Gateway to AC

For connecting to power, use the supplied power supply:

1. Connect the power supply cable connector to the connector labeled **DC** on the Firefighter Gateway (see *Figure 3*).
2. Connect the power supply to the AC mains. The LEDs are lit momentarily to indicate power connection (see *Figure 3*).

CAUTION!



If you use a non-SolarEdge power supply, check that it has 12Vdc/1A output ratings, and that it is certified to UL/CSA/IEC60950-1 2ed standards. Limited Power Source output, NEC class 2. Verify the power supply polarity as marked on the gateway.

Chapter 3: Connecting the Firefighter Gateway to the Installation

Overview

The Firefighter Gateway connects to the PV system installation using the RS485 communication option. The RS485 option enables creating a chain (bus) of up to 31 slave SolarEdge devices, connected to one master, which can be another SolarEdge device or the Firefighter Gateway.



NOTE

Only SolarEdge devices (inverters, Commercial Gateways (CCGs) and Dataloggers) are allowed on the RS485 communication bus.

The following is an example of a slave gateway connected to a chain of slave inverters (one inverter is the master).

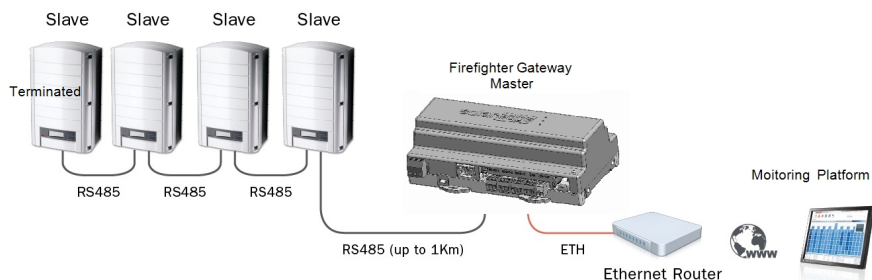

Figure 6: Example of RS485 connection

The following sections describe how to connect the RS485 bus and how to configure its components.

Creating an RS485 Bus Connection

The RS485 bus uses a three-wire cable connecting the RS485-1 terminal blocks on the Firefighter Gateway to the RS485 input of the inverters.

→ To connect the RS485 communication bus between inverters and the Firefighter Gateway:

1. Use one of the supplied 3-pin terminal blocks: Loosen the screws and insert the wire ends into the A, B and G pins. For connections longer than 10m use twisted pair wires for A and B wires.

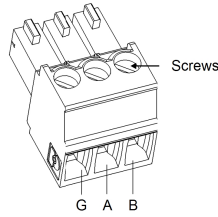

Figure 7: 3-pin terminal block

2. Connect the 3-pin terminal block to the designated RS485-1 port on the Firefighter Gateway.



NOTE
 RS485-1 is configured as SolarEdge device by default, therefore RS485-1 is used as the RS485 bus connection point.

3. If the Firefighter Gateway is at the end of the RS485 chain, terminate the Firefighter Gateway by switching a termination DIP switch to ON. The switches in the SolarEdge Firefighter Gateway are marked **SW1** for the RS485-1 port termination (and **SW2**), as shown below:



Figure 8: RS485 connectors and termination switches

4. Open the inverter cover as described in their manual.
5. Remove the seal from one of the openings in communication gland #2 of the inverter and insert the cable through the opening.
6. Pull out the 9-pin RS485 terminal block connector, as shown below:

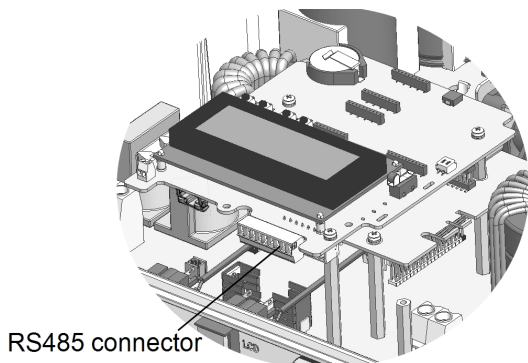

Figure 9: The RS485 terminal block in the inverter

7. Loosen the screws of pins B, A and G on the left of the RS-485 terminal block.

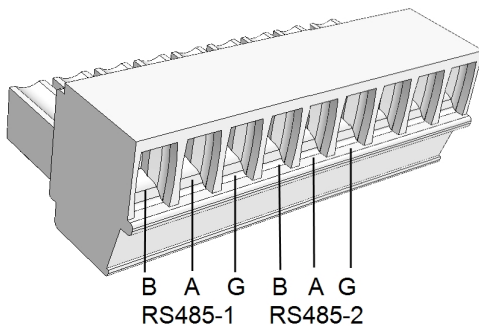

Figure 10: RS485 terminal block

8. Insert the wire ends into the G, A and B pins shown above. You can use any color wire for each of the A, B and G connections, as long as the same color wire is used for all A pins, the same color for all B pins and the same color for all G pins.
9. Connect all B, A and G pins in all inverters. The following figure illustrates this connection schema (the illustration applies to inverters):

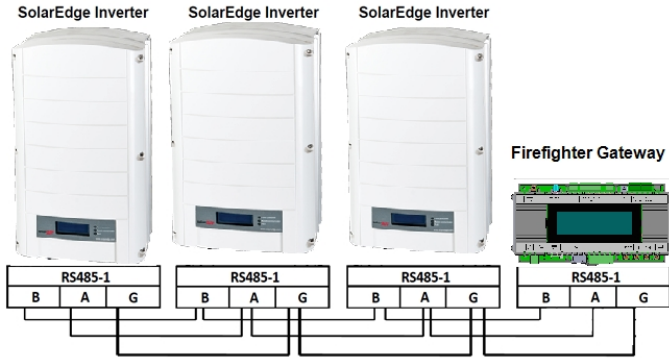

Figure 11: Connecting SolarEdge inverters in a chain



NOTE

Do not cross-connect B, A and G wires.
Do not insert wires into RS485-2 pins.

10. Tighten the terminal block screws.
11. Push the RS485 terminal block firmly all the way into the communication board.
12. Terminate the inverters at the two ends of the chain by switching a termination DIP-switch inside the inverter to ON (move the switch to the top). The switch is located on the communication board and is marked **SW7**.

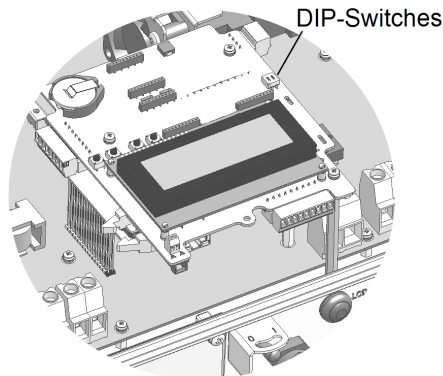

Figure 12: RS485 termination switch

NOTE



Only the first and last SolarEdge devices in the chain should be terminated. The other devices in the chain should have the termination switch OFF.

→ To configure the RS485 communication bus with SolarEdge inverters:

By default, all SolarEdge devices are pre-configured as slaves on the RS485-1 port. Slaves can be further configured using the **RS485-X Conf** option in the Communication menu.

One device must be set as the master on the RS485 bus. Any SolarEdge device may be the master (Firefighter Gateway, inverter). If you connect the installation to the SolarEdge monitoring platform, the device used to connect to the server must be the master.

The following describes how to configure the master device.

1. Press the **Enter** button until the following message is displayed:

```
Please enter  
Password  
*****
```

2. Use the three-right most LCD buttons to type in the following password: **12312312**

The following menu is displayed:

```
Language <Eng>  
Communication  
Remote Shutdown  
Power Control  
Display  
Maintenance  
Information
```

3. Short-press the arrow buttons to scroll to the Communication menu. Press the Enter button to select it.
4. Select **Server** → **RS485-X Conf** (X=1 or 2 depending on the specific physical port connection) to communicate with different external devices.
5. To configure the master, select the following in the LCD menus:
 - **Communication** → **RS485-1 Conf** → **Device Type** → **SolarEdge**
 - **RS485-1 Conf** → **Protocol** → **Master**
 - **RS485-1 Conf** → **Slave Detect**

The system starts automatic detection of the SolarEdge slave inverters connected to the master Firefighter Gateway. The Firefighter Gateway should report the correct number of slaves. If not, verify the connections and terminations. Verify that only one master is configured on the bus.

6. Close the inverter cover and start power production.
7. On the firefighter gateway main status screen, verify that "Dev. On", "Dev. Safe" and "Max Vdc" values are set according to your setup. That is, if you connected three slaves:
 - Dev. On = 3/3
 - Dev. Safe = 0/3
 - Max Vdc = Voltage of the slave with highest DC voltage

```
PV Normal Operation
003/003 Dev. ON
000/003 Dev. Safe
Max. VDC: 150 V
```

The PV installation is now connected to the firefighter gateway. Power production can now be stopped at emergencies.

8. Test the Emergency system shutdown as described in *Emergency System Shutdown* on page 39

Verifying the Connection

1. After connection, a message similar to the following appears in the main status screen (see also *Initial Status* on page 29):

```
< Status >
XXX/YYY Dev. ON
ZZZ/YYY Dev. Safe
Max. VDC: 750 V
```

2. Assuming that the system is producing power, check:
 - XXX - number of devices that are connected to the gateway
 - YYY - number of inverters that are connected and ON
 - ZZZ=0 - number of devices in Safe mode, that is, disconnected or shut down.
3. If **No Communication** or **Partial Com.** appear in the first line, refer to *Troubleshooting the RS485 Communication*, below.

Troubleshooting the RS485 Communication

1. If **No Communication** is displayed on the SolarEdge Firefighter Gateway, perform the following:
 - Verify that the RS485 cable is connected to all inverters. Check the connections between the first inverter in the chain and the other inverters.
 - Verify that one of the devices is defined as the master and that slaves were detected, as described above.
2. If **Partial Com.** is displayed on the firefighter gateway, one or more inverters are disconnected from the bus. Perform the following:
 - Verify that the RS485 cable is connected to all inverters.
 - Check the Server Communication Status screen of all the inverters. The following should appear:

```
Server: RS485  
Status: OK
```

3. If the message **Master Not Found** appears, check the connections to the master device and fix if required.
4. If after slave detection the number of slaves displayed in the master under **RS485-X Conf → Slave Detect** is smaller than the actual number of slaves, use one of the following methods to identify missing slaves and troubleshoot connectivity problems:
 - Use the **Long slave Detect** to retry connecting to slaves
 - Analyze the **Slave List** to check for missing slaves, and check their connection



Refer to https://www.solaredge.com/sites/default/files/troubleshooting_undetected_RS485_devices.pdf

Creating an Ethernet (LAN) Connection

This communication option enables using an Ethernet connection to connect the to the monitoring platform through a LAN.

Ethernet cable specifications:

- Cable type – a shielded Ethernet cable (Cat5/5E STP) may be used
- Maximum distance between the and the router – 100 m/ 330 ft.

NOTE

If using a cable longer than 10 m / 33 ft in areas where there is a risk of induced voltage surges by lightning, it is recommended to use external surge protection devices.



For details refer to: http://www.solaredge.com/files/pdfs/lightning_surge_protection.pdf.

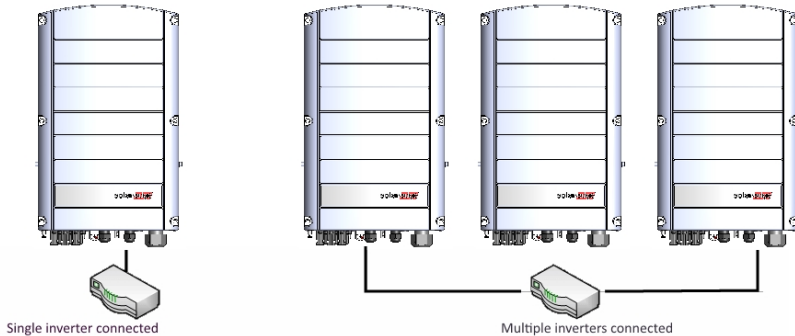

Figure 13: Example of Ethernet connection

→ **To connect the Ethernet cable:**

1. Remove the cover .
2. Open the communication gland #1.

**CAUTION!**

The gland includes a rubber waterproof fitting, which should be used to ensure proper sealing.

3. Remove the plastic seal from one of the large opening .
4. Remove the rubber fitting from the gland and insert the CAT5/6 cable through the gland and through the gland opening in the
5. Push the cable into the cut opening of the rubber fitting.

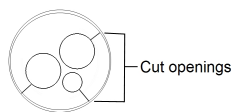

Figure 14: Rubber fitting

CAT5/6 standard cables have eight wires (four twisted pairs), as shown in the diagram below. Wire colors may differ from one cable to another. You can use either wiring standard, as long as both sides of the cable have the same pin-out and color-coding.

RJ45 Pin #	Wire Color ⁽¹⁾		10Base-T Signal 100Base-TX Signal
	T568B	T568A	
1	White/Orange	White/Green	Transmit+
2	Orange	Green	Transmit-
3	White/Green	White/Orange	Receive+
4	Blue	Blue	Reserved
5	White/Blue	White/Blue	Reserved
6	Green	Orange	Received-
7	White/Brown	White/Brown	Reserved
8	Brown	Brown	Reserved

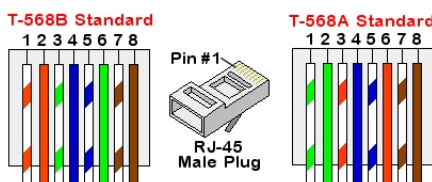

Figure 15: Standard cable wiring

6. Use a pre-terminated cable to connect via gland #1 to the RJ45 plug on the inverter's communication board or, if using a spool of cable, connect as follows:
 - a. Insert the cable through gland #1.
 - b. Remove the cable's external insulation using a crimping tool or cable cutter and expose eight wires.
 - c. Insert the eight wires into an RJ45 connector, as described in *Figure 15*.
 - d. Use a crimping tool to crimp the connector.
 - e. Connect the Ethernet connector to the RJ45 port on the board.

⁽¹⁾The connection does not support RX/TX polarity change. Supporting crossover Ethernet cables depends on the switch capabilities.

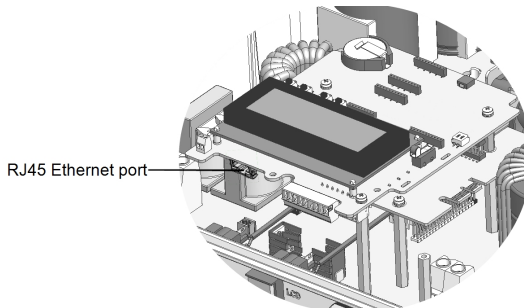

Figure 16: The RJ45 Ethernet connection

7. For the switch/router side, use a pre-crimped cable or use a crimper to prepare an RJ45 communication connector: Insert the eight wires into the RJ45 connector in the same order as above (*Figure 15*).
8. Connect the cable RJ45 connector to the RJ45 port of the Ethernet switch or router. You can connect more than one inverter to the same switch/router or to different switches/routers, as needed. Each inverter sends its monitored data independently to the monitoring platform.
9. The is configured by default to LAN. If reconfiguration is required:
 - a. Make sure the ON/OFF switch is OFF.
 - b. Turn ON
 - c. Use the internal user buttons to configure the connection, as described in *Communication* on page 34.

NOTE

If your network has a firewall, you may need to configure it to enable the connection to the following address:



- Destination Address: prod2.solaredge.com
- TCP Port: 22222, 22221, or 80 (for incoming and outgoing data)

10. Verify the connection, as described in *Verifying the Connection* on page 27. *Verifying the Connection* on page 27.

Verifying the Connection

After connecting and configuring a communication option, perform the following steps to check that the connection to the monitoring server has been successfully established.

1. Close the inverter cover: Attach the inverter cover and secure it by tightening the screws with a torque of . For proper sealing, first tighten the corner screws and then the two central screws.
2. If not already ON - Turn ON the AC to the inverter by turning ON the circuit breaker on the main distribution panel and turning on the (if applicable).
3. Wait for the inverter to connect to the SolarEdge monitoring platform. This may take up to two minutes.

A status screen similar to the following appears on the LCD panel:

```
Vac[V] Vdc[V] Pac[w]
240.7 14.1 0.0
P_OK: 000/000 <S_OK>
          OFF
```

S_OK: Indicates that the connection to the SolarEdge monitoring platform is successful. If S_OK is not displayed, refer to .

Additional Connection Options

Creating a Wireless ZigBee Connection

This communication option enables using a ZigBee connection to connect one or several devices to the monitoring platform.

The ZigBee device is provided with a user manual, which should be reviewed prior to connection. It is available on the SolarEdge website at <http://www.solaredge.com/groups/products/communication> (under ZigBee).



Creating a Wi-Fi Connection

This communication option enables using a Wi-Fi connection for connecting the device to the monitoring platform.

The Wi-Fi Plug-in kit can be purchased separately and assembled during system installation. The Wi-Fi Plug-in kit is provided with a user manual, which should be reviewed prior to connection. It is available on the SolarEdge website at <http://www.solaredge.com/groups/products/communication> (under Wi-Fi).



Chapter 4: LCD – Status Screens and Setup Options

This chapter describes the LCD display of the SolarEdge Firefighter Gateway. The LCD screen displays status information of the Firefighter Gateway and various menus for configuration.

Status Screens - Operational Mode

During normal operation pressing the **Enter** button turns on the LCD backlight. The backlight is active for 30 seconds by default. This duration is configurable, as described in *Display* on page 37.

Additional presses display the following screens one after the other.

Initial Status

This screen displays the communication and safety status of components in the system:

```
< Status >
XXX/YYY Dev. ON
ZZZ/YYY Dev. Safe
Max. VDC: 750 V
```

- **Status:** can be one of the following system stages:
 - **PV Normal Operation**
 - **PV Shutting Down** – appears when pressing the emergency stop button
 - **PV Reducing Voltage** - appears during emergency stop
 - **PV System Safe** – appears when the system reaches 120 V after pressing the emergency stop button
 - **No Communication** – indicates that the slave devices are disconnected from the master
 - **Partial Com.** – indicates the number of communicating devices (inverters) out of the total number of devices in the installation
- **XXX/YYY Dev. ON:** The number of operational inverters out of the total number of inverters in the installation
- **ZZZ/YYY Dev. Safe:** Number of inverters that reached the safety threshold voltage or below, out of the total number of inverters in the installation
- **Max. Vdc:** Real-time maximum DC voltage for the entire installation

ID Status

This screen displays the ID of the Firefighter Gateway and the software version.

```
ID:      ##### ##
DSP1:    1.0210
CPU:     0003.19xx
Country:      ESP
```

Server Communication Status

```
Server: LAN <S_OK>
Status:   <OK>
          xxxxxxxx
<ERROR MESSAGE>
```

NOTE



If the connection method is CDMA (referred to as "Cellular" in the status screens) or GSM, the server screen is replaced with the Cellular or GSM status screens (see *Status Screens - Operational Mode* on page 29 and *GSM Status* on page 32).

- **Server:** The method of connection to the SolarEdge monitoring platform.
 - LAN
 - RS232
 - RS485 (only applicable for slave SolarEdge devices on the RS485 bus)
 - ZigBee (only applicable for slave ZigBee devices)
 - Wi-Fi
 - None
- **S_OK:** The connection to the SolarEdge monitoring platform is successful (should appear only if the inverter is connected to the server).
- **Status:** Displays OK if the established successful connection and communication with the specified server port/ (LAN, RS485, Wi-Fi or ZigBee Plug-in).
- **xxxxxxx:** Eight-bit Ethernet communication connection status: A string of 1s and 0s is displayed. 1 indicates OK, 0 indicates an error. For a list of possible errors and how to troubleshoot them, refer to on page 56. For a list of the possible errors and how to troubleshoot them, refer to *Errors and Troubleshooting* on page 56.
- **Error message,** according to failure. Refer to <http://www.solaredge.com/sites/default/files/se-inverter-installation-guide-error-codes.pdf>.

IP Status

This screen describes the Ethernet configuration: IP, Mask, TCP Gateway and MAC address (Media Access Control) of the Firefighter Gateway.

```
IP 192.168.2.119
MSK 255.255.255.0
GW 192.168.2.1
MAC 0-27-02-00-39-36
```

ZigBee Status

This screen describes the ZigBee configuration:

```
PAN:XXXXX
CH:XX/XXXX RSSI: <L>
MID:XXXX XX
ZigBee Ready
```

- **RSSI:** The receive signal strength indication of the closest ZigBee in the system. L = low, M = medium, H = high and (-) = no signal.
- **PAN ID:** The ZigBee transceiver PAN ID (Personal Area Network Identification), the ID uniquely represents a device in a Zigbee network.
- **Ch.:** The ZigBee transceiver channel
- **ID:** The ZigBee transceiver ID
- **MID:** The Master ID of the coordinator (master) ZigBee Plug-in. This field is shown only in devices with router (slave) ZigBee cards, and after a successful ZigBee association. If a ZigBee Plug-in is not connected, a **No ZigBee** message is displayed instead of the **MID** field.
- **ZigBee Ready:** This field is shown only in devices with ZigBee router transceivers (slaves), in a multi-point (MP) protocol configuration. If a ZigBee transceiver is not physically connected, a **No ZigBee** message is displayed.

Wi-Fi Status

This screen describes the Wi-Fi configuration:

```
IP: 192.168.2.119
GW: 192.168.2.1
SSID: xxxxxxxx
RSSI: <L/M/H/->
```

- **IP:** The DHCP provided address
- **GW:** The gateway IP address

- **SSID:** Service Set Identifier - the name of a wireless local area network (WLAN). All wireless devices on a WLAN must employ the same SSID in order to communicate with each other.
- **RSSI:** The receive signal strength indication of the closest Wi-Fi in the SolarEdge system. L = low, M = medium, H = high and - = no signal.

GSM Status

If a GSM Plug-in is connected, this screen replaces the Server status screen:

```
Server: Cell <S_OK>
Status:      <OK>
MNO: <xxxxxxx> Sig: 5
<Error message>
```

- **Server:** The method of communication to the SolarEdge monitoring platform. Should display **Cell**.
- **Status:** Displays OK if the inverter established a successful physical connection to the modem.
- **S_OK:** The last communication to the SolarEdge monitoring platform was successful (appears if the inverter is connected to the platform). If S_OK is not displayed, refer to *Status Screens - Operational Mode* on page 29.
- **MNO:** The mobile network operator name
- **Sig:** The signal strength, received from the modem. A value between 0-5, (0 = no signal; 5 = excellent signal)
- **Error message:** per communication connection status failure

Communication Ports Status

This screen presents the communication port (RS485-1/2 or ZigBee), and the devices connected to them, with details about the number, type, and protocol.

```
Dev Prot ##
RS485-1 <SE> <S > <-->
RS485-2 <SE> <S > <-->
ZigBee <SE> <MPS> <-->
```

- **##:** The total number of slaves detected on the specific port
- **Dev:** The type of device that was configured to a specific port (based on the port's functionality), as follows:
 - **SE:** SolarEdge device (default)
 - **LGR:** Non-SolarEdge logger
 - **MLT:** Multiple devices, such as meters and batteries
 - **HA:** Home automation devices (for Smart Energy)
- **PROT:** The protocol type to which the port is set:
- For a SolarEdge device:

RS485 protocol	ZigBee protocol
S: SolarEdge slave	
M: SolarEdge master	
	P2P: ZigBee point-to-point
	MPM: ZigBee multipoint master (for the ZigBee gateway or for load management by the inverter)
	MPS: ZigBee multipoint slave (for a ZigBee router card)

- For electricity meters, refer to the *application note - Connecting an Electricity Meter to SolarEdge Devices* at <http://www.solaredge.com/files/pdfs/solaredge-meter-installation-guide.pdf>.
- **SS:** SunSpec - for a non-SolarEdge logger (monitoring and control)



Configuration Menu Options

This section describes basic Firefighter Gateway configuration options.

→ To enter Setup mode:

1. Verify that the SolarEdge Firefighter Gateway is connected to a power outlet.
2. Press the Enter button until the following message is displayed:

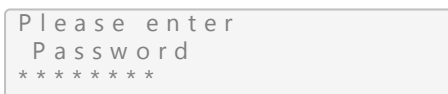

The Firefighter Gateway is now in Setup mode and all its LEDs are lit. The Firefighter Gateway automatically exits Setup mode if no buttons are pressed for more than 2 minutes.

3. Use the three-right-most LCD buttons to type in the following password: **12312312**. The following message is displayed:

```
Language <Eng>
Communication
Remote Shutdown
Power Control
Display
Maintenance
Information
```

Language

1. Select the **Language** option to set the language in which the LCD should display.
2. Confirm your language selection in the confirmation screen: Toggle to **YES** and press **Enter**.

Communication

1. Select the **Communication** option to define and configure:
 - The communication option used by the Firefighter Gateway to communicate with the SolarEdge monitoring platform
 - The communication option used to communicate between multiple SolarEdge devices or other external non-SolarEdge devices, such as energy meters or loggers.



NOTE

The Server menu shows only the communication options installed in the Firefighter Gateway.

The following shows a hierarchical tree of the menu options in the **Communication** menu.

For detailed information about all the configuration options, refer to the *Communication Options Application Note*, available on the SolarEdge website at http://www.solaredge.com/files/pdfs/solaredge-communication_options_application_note_v2_250_and_above.pdf.



Communication^{(1), (2)}:

```
Server < LAN >  
LAN Conf  
RS485-1 Conf < S >  
RS485-2 Conf < S >  
ZigBee Conf < S >  
Wi-Fi Conf < N/A >  
Cellular Conf  
Slave Detect
```

Server:

```
LAN  
RS485  
Zigbee  
Wi-Fi  
Cellular  
None
```

LAN Conf:

```
IP Config  
Set DHCP < en >  
Set IP  
Set Mask  
Set Gateway  
Set DNS  
Set Server Addr  
Set Server Port  
Modbus TCP < Dis >
```

(1) If ZigBee is connected, the Wi-Fi Conf menu is not displayed. If ZigBee is not connected, ZigBee Conf and Wi-Fi Conf are both displayed with <N/A> and their menus are not accessible.

(2) When using the SolarEdge GSM products, RS232 Conf menu is unavailable.

RS485-X Conf:

```
Device Type <SE>
Protocol <M>
Device ID <1>
Slave Detect <#>
Cluster SLV Detect
Long Slave Detect <#>
Slave List <#>
Multi-Inv. Set
```

ZigBee Conf. (enabled only if the ZigBee internal card is connected):

```
Device Type <SE>
Protocol <MPS>
Device ID <1>
PAN ID
Scan Channel
Load ZB Defaults
```

Wi-Fi Conf (enabled only if the internal card is connected):

```
Scan Networks
Set key
Load Defaults
```

GPIO Conf:

```
Device Type <RRCR>
```

Power Control

Power control options are detailed in the *Power Control Application Note*, available on the SolarEdge website at http://www.solaredge.com/files/pdfs/application_note_power_control_configuration.pdf.



Remote Shutdown

Select **Remote Shutdown** to set the following:

```
L1 Polarity <Norm.>
L2 Polarity <Norm.>
Safe Vdc <120V>
Clr Alarm Mode <M>
Clear Alarm
```

For detailed information refer to *Connecting and Configuring an Emergency Stop Button to the Gateway* on page 51.

Display

Select **Display** to set the following:

```
LCD On Time <30>
```

- **Temperature:** Select Celsius or Fahrenheit units.
- **LCD On Time <30>:** The number of seconds that the LCD backlight is ON after pressing the LCD light button. Set a value within the range of 10-120 seconds.
- **TLM On Time <15>:** The number of minutes that the LCD backlight is ON while viewing the Telemetry window. Set a value within the range of 1-120 minutes.

Maintenance

Select **Maintenance** to set the following options:

```
Date and Time  
Factory Reset  
FW Upgrade
```

- **Date and Time:** Set the internal real-time clock. If connected to the SolarEdge monitoring platform, the date and time are set automatically and only time zone should be set.
- **Factory Reset:** Performs a general reset to the default device settings.
- **FW Upgrade:** Perform a software upgrade by using an SD card. Refer to [upgrading_an_inverter_using_micro_sd_card.pdf](#).



Information

Select **Information** to display the following options:

```
Versions
Error Log
Warning log
Hardware IDs
```

- **Versions:** Displays firmware versions:
 - **ID:** The ID.
 - **DSP 1:** The DSP digital control board firmware version
 - **CPU:** The communication board firmware version



NOTE

Please have these numbers ready when you contact SolarEdge Support.

- **Error Log:** Displays the last five errors.
- **Warning Log:** Displays the last five warnings.
- **Hardware IDs:** Displays the following HW serial numbers (if exist, and connected to the inverter):
 - **ID:** the inverter's ID
 - **RGM1** (Revenue Grade Meter): Energy Meter with Modbus Connection
 - **RGM2:** A second external Energy Meter with Modbus Connection
 - **ZB:** ZigBee MAC address
 - **Cell:** MEID (CDMA) or IMEI (GSM)
 - **WiFi:** Wi-Fi MAC address

Chapter 5: Emergency System Shutdown

In emergencies, use the emergency stop button to stop power production.

Use this procedure also to test the PV system shutdown using the firefighter gateway.

→ To stop PV harvesting system power production:

1. On the firefighter gateway, press the Enter button to light up the LCD and display the main status screen. Check that a message similar to the following appears, and that the first line does NOT display No Communication or Partial Com.:

```
PV Normal Operation
003/003 Dev. ON
000/003 Dev. Safe
Max. VDC: 150 V
```

WARNING!



If the RS485 communication between the firefighter gateway and inverters is disconnected for any reason (including damage to cables caused by a fire), the firefighter gateway LCD will display "No Communication" or "Partial Com". In this case, the firefighter gateway CANNOT be relied upon to disconnect the SolarEdge PV harvesting system.

2. Press the emergency stop button. The PV system starts the shutdown sequence.
3. On the firefighter gateway LCD, check the main status screen. A message similar to the following should appear:

```
PV Shutting Down
001/003 Dev. ON
002/003 Dev. Safe
Max. Vdc: 150 V
```

The status changes to PV Reducing Voltage. The shutdown is immediate but safe indication will take 3 to 5 minutes until the inverter capacitors are discharged.

Upon reaching safety voltage (default: 120V), the following message appears on the firefighter gateway LCD:

```
PV System safe
```

WARNING!

If the communication between the firefighter gateway and the inverters is not available during the shutdown sequence, the following message appears on the LCD: System Failed to Shutdown If this occurs:

1. Shutdown the AC power to the inverters.
2. Wait 3 to 5 minutes until the capacitors are discharged.

On the inverters LCD display, the following message appears upon reaching safe voltage:

```
Firefighter  
Remote Shutdown
```

NOTE

The **Maintenance** menu in the inverters LCD includes a Clear Alarm option that appears only in remote shutdown. This enables clearing the remote shutdown state for a specific device if required.

4. Disconnect the AC power to the inverters.

→ To regain system normal operation:

1. Release the emergency stop button.
2. Turn ON the AC power.
3. Do one of the following:
 - If you set the **Clear Alarm Mode** in the firefighter gateway to **Automatic** (refer to *Connecting and Configuring an Emergency Stop Button to the Gateway* on page 51), check the firefighter gateway main status screen displays the status **PV Normal Operation**.
 - If you set the **Clear Alarm Mode** in the firefighter gateway to Manual, do the following:
 - Enter Setup mode, as described in *enter Setup mode:* on page 33.
 - Select **Fire Safety** → **Clear Alarm** → **Yes**. the following is displayed:



Clearing Alarm...

- If the alarm was cleared, the following is displayed:



Alarm Cleared

If **Failed** is displayed, check that you have unlocked the emergency stop button.

4. On the firefighter gateway LCD, check the main status screen. A message similar to the following should appear:



PV Normal Operation
003/003 Dev. ON
000/000 Dev. Safe
Max. VDC: 164 V

5. If there is no communication between slave inverters and the master gateway, clear the alarm from the inverter, as follows:
 - a. Enter Setup mode in the inverter LCD menu.
 - b. Select **Maintenance** → **Clear Alarm**.

Chapter 6: Setting Up Monitoring through the Firefighter Gateway (Optional)

Communication Dataflow

The SolarEdge site information can be accessed remotely using the SolarEdge monitoring platform. In order to transfer monitoring data from a SolarEdge site to the SolarEdge monitoring platform, a communications connection must be established. Communications are not required for power harvesting - they are required only when using the monitoring platform.

Any SolarEdge device can serve as the connection point. This chapter describes how to set up this connection with the FFG serving as the connection point to the monitoring platform. The FFG should be the master on an RS485 bus.

Communication Options

The following types of communication can be used to transfer the monitored information from the inverter to the monitoring platform through the Firefighter Gateway.

Only communication products offered by SolarEdge are supported.

Ethernet

Ethernet is used for a LAN connection. For connection instructions refer to *Creating an Ethernet (LAN) Connection* on page 44.

RS485

RS485 is used for the connection of multiple SolarEdge devices on the same bus in a master-slave configuration. RS485 can also be used as an interface to external devices, such as meters and third party data loggers

- RS485-1: Enables the connection of multiple devices (inverters/Firefighter Gateway) over the same bus, such that connecting only one device to the Internet is sufficient to provide communication services for all the devices on the bus.
- RS485-2: Enables connection of multiple SolarEdge devices and of non-SolarEdge devices over the same bus.

For connection instructions refer to *Creating an RS485 Bus Connection* on page 18

Wi-Fi

This communication option enables using a Wi-Fi connection for connecting to the monitoring platform.

The Wi-Fi option requires a Wi-Fi Plug-in and an external antenna, available from SolarEdge in a kit, which can be purchased separately and assembled during system installation. The Wi-Fi Plug-in kit is provided with a user manual, which should be reviewed prior to connection. Refer to http://www.solaredge.com/sites/default/files/se_wifi_communication_solution_installation_guide.pdf



Cellular (GSM, CDMA)

This wireless communication option (purchased separately) enables using a cellular connection to connect one or several devices (depending on the data plan used) to the monitoring platform.

The GSM/CDMA Plug-in is provided with a user manual, which should be reviewed prior to connection. Refer to https://www.solaredge.com/sites/default/files/cellular_gsm_installation_guide.pdf



ZigBee

To mount the ZigBee Plug-in in the Firefighter Gateway, see "Mounting the ZigBee Plug-in in the Firefighter Gateway" on page 48

- **Smart Energy Management** - wireless connection to one or several Smart Energy products, which automatically divert PV energy to home appliances.

The Smart Energy products are provided with an installation guide, which should be reviewed prior to connection. Refer to <https://www.solaredge.com/products/device-control#/>.

The ZigBee Plug-in for Smart Energy is provided with an installation guide, which should be reviewed prior to connection. Refer to <https://www.solaredge.com/sites/default/files/se-device-control-zigbee-module-installation-guide.pdf>

To mount the ZigBee Plug-in in the Firefighter Gateway, see *Mounting the ZigBee Plug-in in the Firefighter Gateway* on page 48.



Creating an Ethernet (LAN) Connection

Overview

This communication option enables using an Ethernet connection to connect the SolarEdge Firefighter Gateway to the monitoring platform through a LAN. The SolarEdge Firefighter Gateway has an RJ45 connector for Ethernet communication.

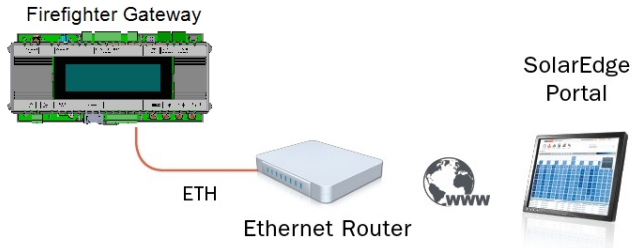

Figure 17: Example of Ethernet connection

Ethernet Communication Configuration Options

The following is a description of the options to configure the Ethernet (LAN) port settings.

Communication:

```
Server < LAN >  
LAN Conf  
RS485-1 Conf < S >  
RS485-2 Conf < S >  
ZigBee Conf < S >  
Wi-Fi Conf < N/A >  
Cellular Conf  
Slave Detect
```

LAN Conf:

```
IP Config
Set DHCP <en>
Set IP
Set Mask
Set Gateway
Set DNS
Set Server Addr
Set Server Port
Modbus TCP <Dis>
```

- **IP Config:** Displays the current IP configuration of the Firefighter Gateway, as shown below. If DHCP is used, this screen reflects the parameters retrieved from the DHCP server. If manual settings are used, the screen shows the last manually input configurations.

```
IP 0.0.0.0
MSK 255.255.255.0
GW 192.168.0.1
DNS 0.0.0.0
```

- **Set DHCP <En>:** If the LAN connection between the Firefighter Gateway and the SolarEdge Monitoring Platform has a DHCP server, enable this option by setting it to Enable (default). If this option is enabled, then the DHCP server automatically configures the IP, Subnet Mask, default gateway and DNS. If not, set them manually.
- **Set IP:** Enables setting the IP of the default gateway according to the LAN settings:
- Use the **Up** and **Down** buttons to adjust the value of each IP address octet.
- Press the **Enter** button to move to the next IP address octet.
- Long press the **Enter** button (until **Applied** message appears) – apply the value
- Long press the **Esc** button (until **Aborted** message appears) – erase all characters

```
Setup IP
192.168.2.7
```

- **Set Mask:** Set the subnet mask of the SolarEdge Firefighter Gateway according to the LAN settings.
- **Set Gateway:** Set the default gateway address of the SolarEdge Firefighter Gateway according to the LAN settings.
- **Set DNS:** Set the DNS of the SolarEdge Firefighter Gateway according to the LAN settings.

- **Set Server Addr:** Set the IP address of the SolarEdge monitoring platform. This option is predefined in the SolarEdge Firefighter Gateway to specify the SolarEdge monitoring platform IP address and does not normally need configuration.
- **Set Server Port:** Set the port through which to connect to the SolarEdge monitoring platform. This option is predefined in the Firefighter Gateway to specify the SolarEdge monitoring platform IP port and normally does not need configuration.

NOTE



If your LAN has a firewall, you must verify that the address and port configured in the **Set Server Addr** and the **Set Server Port** fields are not blocked. You may need to configure it to enable the connection to the following address:

Destination Address: prod.solaredge.com

Port: 22222

Connecting and Configuring LAN

→ To connect the Ethernet cable to the router/switch:

1. Use a pre-terminated cable or use a crimping tool to prepare an RJ45 communication connector on both ends of a standard CAT5/6 cable: Insert the eight wires into the RJ45 connector.

CAT5/6 standard cables have eight wires (four twisted pairs), as shown in the diagram below. Wire colors may differ from one cable to another. You can use either wiring standard, as long as both sides of the cable have the same pin-out and color-coding.

RJ45 Pin #	Wire Color		10Base-T Signal 100Base-TX Signal
	T568B	T568A	
1	White/Orange	White/Green	Transmit+
2	Orange	Green	Transmit-
3	White/Green	White/Orange	Receive+
4	Blue	Blue	Reserved
5	White/Blue	White/Blue	Reserved
6	Green	Orange	Received-
7	White/Brown	White/Brown	Reserved
8	Brown	Brown	Reserved

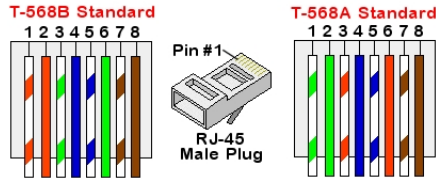

Figure 18: Standard cable wiring

2. Connect one end of the Ethernet cable to the RJ45 plug at the router or Ethernet gateway that is connected to the Internet.
3. Thread the other end through a gland and connect to the Firefighter Gateway Ethernet connector.
4. Verify that the yellow communication LED turns ON.

→ To configure Ethernet communication to the SolarEdge monitoring platform:

Define the device connected to the monitoring platform as the master device.

The server communication method is configured by default to **LAN with DHCP enabled**.

If a different setting is required, follow the steps below:

1. Enter Setup mode, as described in: *To enter Setup mode:* on page 33.
2. Set the Firefighter Gateway as the master of the RS485 bus and perform slave detection as described in ". *Creating an RS485 Bus Connection* on page 18
3. To configure the LAN to Static IP select the following in the LCD menus on the Firefighter Gateway:
 - Communication → Server → LAN
 - LAN Conf → Set DHCP → <Dis>
4. Set the IP, subnet mask, gateway DNS, server address, and server port as necessary using the LCD User buttons. Refer to the *Ethernet Communication Configuration Options* on page 44.
5. Verify the that the status field in the Server Communication Status window displays S_OK:

```
Server: LAN <S_OK>
Status: <OK>
      x x x x x x x x
<ERROR MESSAGE>
```

6. Exit the Setup mode.

Appendix A: Mounting the ZigBee Plug-in in the Firefighter Gateway



NOTE

The ZigBee Plug-in should be purchased separately.

1. Turn the inverter Safety Switch (if applicable) to OFF.
2. Turn the inverter ON/OFF switch to OFF.
3. Disconnect the AC to the inverter by turning OFF the circuit breakers on the distribution panel. Wait 5 minutes for the capacitors to discharge.
4. Open the Firefighter Gateway cover.
5. Unscrew the nut and washer on the ZigBee Plug-in.
6. Connect the ZigBee Plug-in in a Firefighter Gateway board as shown below, and ensure that:
 - the antenna connector at the end of the ZigBee Plug-in goes through the bracket.
 - all pins are correctly positioned in the Firefighter Gateway socket and no pins are left out of their socket.
 - the card is firmly in place.

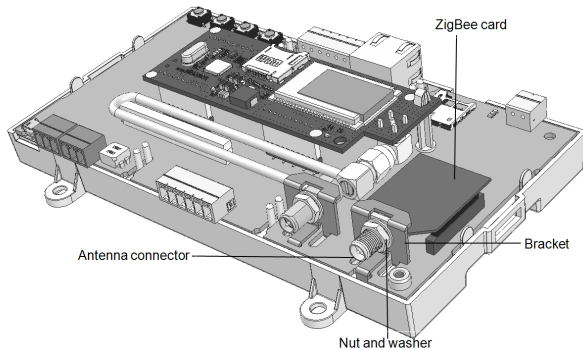

Figure 19: ZigBee Plug-in on a Firefighter Gateway board

3. Screw in the nut and washer on the ZigBee Plug-in
4. Connect the antenna.
5. Replace the Firefighter Gateway cover.

Appendix B: Connecting Emergency Stop Button or Fire Alarm Control

Overview

An external emergency stop button (not supplied by SolarEdge) should be connected to the firefighter gateway, in order to shut down the PV system in case of emergency. Pressing the emergency stop button starts the shutdown sequence of the PV system. Preferably, use a button with a locking feature that stays mechanically locked in the off position until you turn it clockwise a quarter turn to unlock and release it. The firefighter gateway can also be connected to a fire alarm control unit that has a relay output. The relay output of the fire alarm control has the same functionality as the button. You can connect both a stop button and a relay together to the same firefighter gateway, or two stop buttons or two relays.

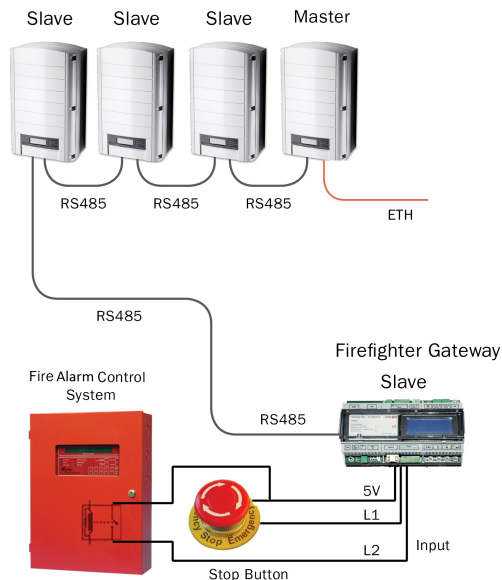

Figure 20: Example: Emergency stop button and fire alarm system connection

The emergency stop button(s) or relay(s) connect to the L1 or L2 ports on the Control connector of the gateway, between 5V and L1 / L2/both. In the following sections, the instructions refer to L1, however applies to L2 as well.

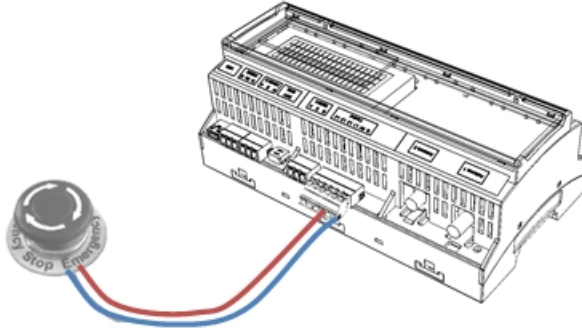
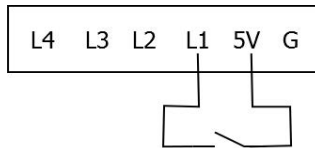

Figure 21: Emergency stop button connection

There are two types of contact states in Emergency Stop buttons/relays:

- **Normally open (NO)** – the contacts are open until closed by operation of the switch. This type of switch should be connected in the following manner:



This installation is safe when L1/L2 has 5V input, and active with L1/L2 is not connected. This is considered Normal polarity in the configuration screen.

- **Normally closed (NC)** – the contacts are closed until opened by operation of the switch. This type of switch should be connected in the following manner:

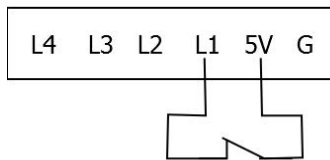

This installation is safe when L1/L2 is not connected and active when L1/L2 is 5V. This is considered Reverse polarity in the configuration screen.

- If you connect more than one firefighter gateways to the same emergency stop button, they should connect to the same grounding, as in the following example:

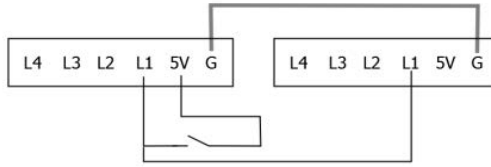

- In some fire alarm control systems, the switch is grounded internally. This type of switch should be connected in the following manner, sharing ground between the control system and the firefighter gateway

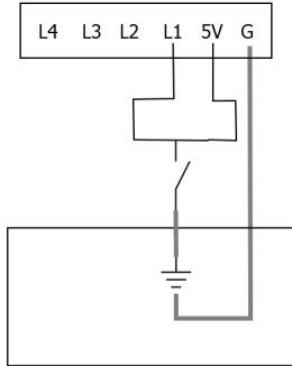

In these cases, a Normally Open relay will connect L1/L2 to ground for safety, and when active, L1/L2 is 5V. This will be configured as a reverse polarity switch.

Connecting and Configuring an Emergency Stop Button to the Gateway

1. Depending on the button/relay type, connect L1/L2, 5V and Ground as described above. Use wire size 20 AWG/ 0.52mm²: Insert the ends of wires into the ports of the supplied 6-pin terminal block.

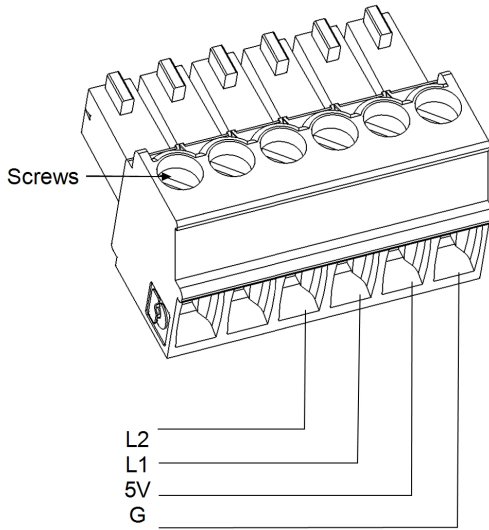

Figure 22: 6-pin Terminal Block

2. Insert the terminal block into the **Control** connector on the firefighter gateway.
3. Verify that the SolarEdge gateway is connected to a power outlet.
4. Press the **Enter** button until the following message is displayed:

```
Please enter  
Password  
*****
```

The gateway is now in Setup mode and all its LEDs are lit.

5. Use the three-right most LCD buttons to type in the following password: **12312312**. The following menu is displayed:

```
Language <Eng>  
Communication  
Remote Shutdown  
Power Control  
Display  
Maintenance  
Information
```

6. Short-press the up/down buttons to scroll to the **Remote Shutdown** menu. Press the Enter key to select it. The remote shutdown parameters are displayed:

```
L1 Polarity <Norm.>  
L2 Polarity <Norm.>  
Safe Vdc <120V>  
Clr Alarm Mode <M>  
Clear Alarm
```

7. Set the following:

- **L1/L2 Polarity:** The lines polarity - Normal (default) or Reverse
- Normal – safety will be activated when L1/L2 has 5V
- Reverse – Safety will be activated when L1/L2 is connected to ground or not connected.
- **Safe Vdc:** Threshold value for safe Vdc: When the maximum DC voltage (of all connected devices) reaches this threshold, the PV system will be considered safe and the display will show Safe DC in the main gateway status screen. You may set the threshold in the range between 30 - 120V (default 120V)
- **Clr Alarm Mode:** Select the method to return to normal operation as soon as the emergency stop button is released:
 - Automatic (default) – when releasing the stop button or relay, the system immediately returns to normal power production.
 - Manual – when releasing the stop button or relay, the system will not return to normal operation unless the user manually clears the alarm by selecting **Clear Alarm** (below). Use this option if the button does not have the locking feature, the relay in the control system may open unexpectedly, or if the user requires this added step.
- **Clear Alarm:** Used to allow normal operation. Appears only if the Clr Alarm Mode parameter (above) is set to Manual, and the installation is in remote safety shutdown

Appendix C: Inserting the GSM Modem in the Firefighter Gateway



NOTE

The GSM modem should be purchased separately.

→ To turn off the inverter, disconnect the AC and insert a SIM card:

1. Turn the inverter Safety Switch (if applicable) to OFF.
2. Turn the inverter ON/OFF switch to OFF.
3. Disconnect the AC to the inverter by turning OFF the circuit breakers on the distribution panel. Wait 5 minutes for the capacitors to discharge.
4. Open the Firefighter Gateway cover.
5. If there is no SIM card installed in the modem, insert one into the slot on the GSM modem.

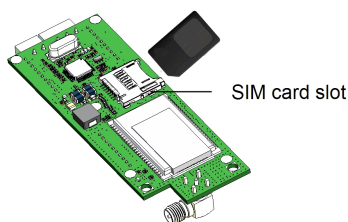

Figure 23: Inserting the SIM card into the GSM modem

→ To install the GSM modem in the Firefighter Gateway:

1. Insert the top of the plastic spacer through the opening in the GSM modem, as shown in *Figure 24*.

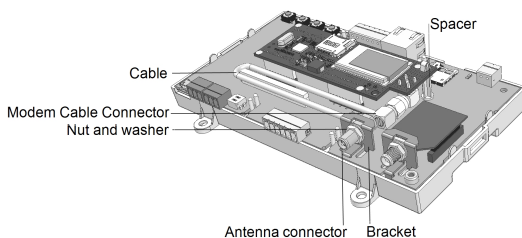

Figure 24: GSM modem on a Firefighter Gateway board

2. Connect one end of the cable to the GSM modem connector.

3. Remove the nut and the washer from the other end of the cable and insert the cable through the bracket on the Firefighter Gateway board.
4. Re-attach and tighten the nut and washer.
5. Place the GSM modem on the Firefighter Gateway board and ensure that:
 - the three rows of pins are correctly positioned in the Firefighter Gateway sockets and no pins are left out of their socket.
 - the GSM modem is firmly in place on the Firefighter Gateway board.
6. Connect the antenna to the antenna connector.
7. Replace the Firefighter Gateway cover.
8. Power on AC.
9. Check that all the GSM modem LEDs are lit. If not, refer to *Errors and Troubleshooting* on page 56.

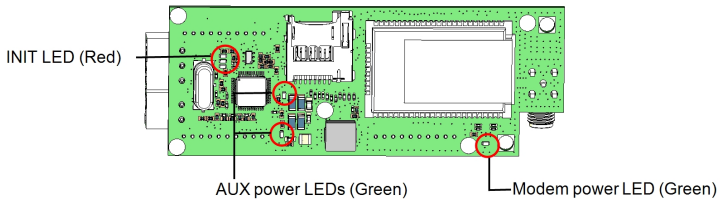

Figure 25: GSM modem LEDs

Appendix D: Errors and Troubleshooting

This appendix describes general system problems, and how to troubleshoot them. For further assistance, contact SolarEdge Support.



Troubleshooting Communication

Troubleshooting Ethernet Communication

When using Ethernet communication, use the **Server Communication Status** window to identify the location of the error:

```
Server: LAN <S_OK>
Status: <OK>
      xxxxxxxx
<ERROR MESSAGE>
```

xxxxxxx is a string of 1s and 0s showing an eight-bit communication connection status. 1 indicates OK and 0 indicates an error.

Bit Location	Error Message	Cause and Troubleshooting
1st	LAN Disconnected	Physical connection fault. Check the cable pin-out assignment and cable connection. Refer to <i>Creating an Ethernet (LAN) Connection</i> on page 44
2nd	DHCP Failed, or Invalid DHCP Config	IP settings issue. Check the router and configuration. Consult your network IT.
3rd	Gateway Ping Failed	Ping to router failed. Check the physical connection to the switch/router. Check that the link LED at the router /switch is lit (indicating phy-link). If OK - contact your network IT, otherwise replace the cable or change it from cross to straight connection.
4th	G Server Ping Failed	Ping to google.com failed. Connect a laptop and check for internet connection. If internet access is unavailable, contact your IT admin or your internet provider. For Wi-Fi networks, ensure that username and password are as defined in the internet provider AP/router.

Bit Location	Error Message	Cause and Troubleshooting
5th	Server x Ping Failed	Ping or connection to SolarEdge server failed. Check the SolarEdge server address, under LAN Conf submenu: Address: prod.solaredge.com Port: 22222 Check with your network administrator whether a firewall or another device is blocking transmission.
6th		
7th		
8th	Tcp Connect. Failed	

- If **No Communication** is displayed on the SolarEdge Firefighter Gateway, perform the following:
 - Verify that the RS485 cable is connected to all inverters. Check the connections between the first inverter in the chain and the other inverters.
 - Verify that one of the devices is defined as the master and that slaves were detected, as described above.
- If **Partial Com.** is displayed on the firefighter gateway, one or more inverters are disconnected from the bus. Perform the following:
 - Verify that the RS485 cable is connected to all inverters.
 - Check the Server Communication Status screen of all the inverters. The following should appear:

```
Server: RS485
Status: OK
```

- If the message **Master Not Found** appears, check the connections to the master device and fix if required.
- If after slave detection the number of slaves displayed in the master under **RS485-X Conf → Slave Detect** is smaller than the actual number of slaves, use one of the following methods to identify missing slaves and troubleshoot connectivity problems:
 - Use the **Long slave Detect** to retry connecting to slaves
 - Analyze the **Slave List** to check for missing slaves, and check their connection



Refer to https://www.solaredge.com/sites/default/files/troubleshooting_undetected_RS485_devices.pdf

Additional Troubleshooting

1. Check that the modem or hub/router is functioning properly.
2. Check that the connection to the internal connector on the communication board is properly done.
3. Check that the selected communication option is properly configured.
4. Use a method independent of the SolarEdge device to check whether the network and modem are operating properly. For example, connect a laptop to the Ethernet router and connect to the Internet.
5. Check whether a firewall or another type of network filter is blocking communication.

Firefighter Gateway Technical Specifications

Power	Description	Units
Power Supply – DIN Rail	Included, 100–240 VAC, EU/UK/US/AU interchangeable 2-pin plug	
Supply Voltage	9-14	Vdc
Connector Type	Terminal block	
Power Consumption	<2	W
Communication Interfaces	Type	
Ethernet Interface	10/100-BaseT	
Wireless Connections	ZigBee Plug-in ⁽¹⁾ , GSM ⁽¹⁾ ⁽²⁾	
Fire Alarm Control Panel Interface	2 alarm inputs, 5V, GND ⁽³⁾	
SolarEdge Inverters	RS485	
Environmental		
Operating Temperatures	-20 to 60 / -4 to 140	°C / °F
Protection Rating	IP20 Indoor	
Mechanical		
Mounting Type	DIN rail/ Wall mount	
Dimensions (L x W x H)	161.6 x 90 x 62 / 6.36 x 3.54 x 2.44	mm / inches
Weight	< 0.5 / 1.1	kg / lbs
Standard Compliance		
Safety	UL60950-1, IEC-60950-1	
EMC	FCC Part 15 class B, IEC61000-6-2, IEC61000-6-3	

(1)Sold separately - see individual product

specs for support locations

(2)EU only

(3)Emergency stop button is not supplied by SolarEdge

If you have technical queries concerning our products, please contact our support through SolarEdge service portal: www.solaredge.com/service/support

Australia (+61)	1800 465 567
APAC (Asia Pacific)(+972)	073 240 3118
Belgium (+32)	0800 76633
Netherlands (+31)	0800 7105
China (+86)	21 6212 5536
DACH & Rest of Europe (+49)	089 454 59730
France (+33)	0800 917410
Italy (+39)	0422 053700
Japan (+81)	03 6262 1223
New Zealand (+64)	0800 144 875
US & Canada (+1)	510 498 3200
United Kingdom (+44)	0800 028 1183
Republic of Ireland (+353)	1 800 901 575
Greece (+49)	89 454 59730
Israel (+972)	073 240 3122
Middle East & Africa (+972)	073 240 3118
South Africa (+27)	0800 982 659
Turkey (+90)	216 706 1929
Worldwide (+972)	073 240 3118