



Home Battery 48V Installation Guide

MAN-01-00954-1.1

For Europe and APAC

Version 1.1

Disclaimers

Important Notice

Copyright © SolarEdge Inc. All rights reserved.

No part of this document may be reproduced, stored in a retrieval system or transmitted, in any form or by any means, electronic, mechanical, photographic, magnetic or otherwise, without the prior written permission of SolarEdge Inc.

The material furnished in this document is believed to be accurate and reliable. However, SolarEdge assumes no responsibility for the use of this material. SolarEdge reserves the right to make changes to the material at any time and without notice. You may refer to the SolarEdge web site (www.solaredge.com) for the most updated version.

All company and brand products and service names are trademarks or registered trademarks of their respective holders.

Patent marking notice: see <http://www.solaredge.com/patent>

The general terms and conditions of delivery of SolarEdge shall apply.

The content of these documents is continually reviewed and amended, where necessary. However, discrepancies cannot be excluded. No guarantee is made for the completeness of these documents.

The images contained in this document are for illustrative purposes only and may vary depending on product models.

This manual describes installation of the SolarEdge Home Battery 48V . Read this manual before you attempt to install the product, and follow the instructions throughout the installation process. If you are uncertain about any of the requirements, recommendations, or safety procedures described in this manual, contact SolarEdge Support immediately for advice and clarification. The information included in this manual is accurate at the time of publication. However, the product specifications are subject to change without prior notice. In addition, the illustrations in this manual are meant to help explain system configuration concepts and installation instructions. The illustrated items may differ from the actual items at the installation location.

Contents

Disclaimers	1
Important Notice	1
Revision History	3
Handling and Safety Instructions	4
Installation	4
Operation	5
Installation Tools	8
Charging cable requirements	8
What's in the Package	9
Battery accessories	9
Selecting and Preparing the Installation Site	10
Configurations	10
General Guidelines and Requirements	11
Restricted Locations	11
Clearance	12
Residential Barrier	13
Installing the Battery Modules	15
Battery description	15
Installation procedure	16
Connecting a Single Battery Module	20
Connecting Multiple Battery Modules	27
Powering on the Battery Module	29
Top Cover Installation	30
Adding or Removing a Battery Module	31
LED Indications	32
Support Contact Information	36

Revision History

Version 1.0 (June 2022)

■ First version of this guide

Version 1.1 (January 2023)

■ Various updates

Handling and Safety Instructions

Read these instructions carefully before installing or operating the SolarEdge Home Battery 48V (referred to as the *Battery* or *Battery Pack*). Failure to do so or to follow any of the instructions or warnings in this document can result in electrical shock, serious injury, or death, or may damage the battery and other property.

Failure to abide by these instructions may void your warranty!

Do not discard this document! After installation, keep it adjacent to the battery for future reference!

Installation

WARNING!



Install the battery according to national and local codes and standards and in locations compliant with local building codes and standards.

WARNING!



The battery installation must be carried out only by qualified electricians who have been trained in handling low voltage electricity works.

WARNING!



The battery module is heavy. Adhere to local regulations for material handling and heavy lifting, when installing heavy equipment.

WARNING!



Do not install the battery in habitable spaces, including sleeping rooms.

WARNING!



Make sure the mounting surface can sustain the total weight of the battery module and mounting bracket.

WARNING!



Do not install the battery, if it has been dropped, crushed, or has signs of physical damage.

WARNING!



When the battery is installed in a residential environment, fire detection and protection equipment must be installed in accordance with local building and fire codes.

WARNING!



Do not install the battery near heating equipment, ignition sources, or open flames.

WARNING!



Install the battery only on non-combustible surfaces and under non-combustible ceilings, overhangs, or eaves.

WARNING!

Do not install the battery in proximity to gas meters, valves, regulators, lines, or gas appliances. Follow local codes. However, 2m or more spacing is highly recommended. A failing battery may ignite flammable gasses resulting in property damage, serious injury, or death.

**WARNING!**

Avoid installing the battery in direct sunlight.

**WARNING!**

Install the battery in a location protected from flooding.

**WARNING!**

Do not install the battery in the vicinity of water sources, including downspouts, sprinklers, or faucets.

**WARNING!**

When installing the battery in a garage or near vehicles, keep it out of the driving path. If possible, install the battery on a side wall and/or above the height of vehicle bumpers.

**WARNING!**

Before beginning the wiring, ensure that the battery is switched off. Also, make sure that the DC safety switch of all inverters in the PV system is turned off.

Operation

WARNING!

The battery contains rechargeable lithium-ion cells that are potentially hazardous and can present a serious fire hazard, injury and/or property damage if damaged, defective or improperly used.

**WARNING!**

Lithium-ion batteries and products that contain lithium-ion can expose you to chemicals, including antimony trioxide, cobalt lithium nickel oxide, and nickel.

**WARNING!**

In case of an electrolyte leak from the battery, avoid contact with electrolyte and follow the instructions in the SolarEdge Home Battery 48V Emergency Response Guide.

**WARNING!**

Use the battery only as directed in this document.

**WARNING!**

Do not use the battery if it is defective, appears cracked, broken, or otherwise damaged, or fails to operate. The battery and its components are not user-serviceable.

WARNING!

Do not attempt to open, disassemble, repair, tamper with, or modify the battery. The battery cells are not replaceable.

WARNING!

Do not operate the battery at ambient temperatures of above 50°C or below -10°C.

WARNING!

Do not expose the battery or its components to direct flame.

WARNING!

Do not store flammable liquids or gasses in the same room with the battery. When the battery is installed outdoors, keep any flammable liquids or gasses at a distance of at least 15m from the battery.

WARNING!

Do not place any combustible items within less than 2m of the battery.

WARNING!

If the battery catches fire, or if fire breaks out near the battery, call the fire department immediately and follow the instructions in the SolarEdge Home Battery 48V Emergency Response Guide.

WARNING!

The battery is prone to re-ignition after extinguishing. Use caution and follow the emergency response instructions. .

WARNING!

Do not immerse the battery or its components in water or other fluids.

WARNING!

Operating the battery in temperatures outside the specified range might cause damage to the battery.

WARNING!

Do not use solvents to clean the battery, or expose the battery to flammable or harsh chemicals or vapors.

WARNING!

Do not use fluids, parts, or accessories other than those specified in this guide, including use of non-genuine SolarEdge parts or accessories, or parts or accessories not purchased directly from SolarEdge or a SolarEdge certified party.

WARNING!

After the installation, do not place the battery in storage conditions for more than one (1) month, or permit the power feed to the battery to be discontinued for more than one (1) month.



WARNING!

Do not paint any part of the battery, including any internal or external components such as the exterior shell or casing.



WARNING!

Ensure that snow does not accumulate around the battery.



WARNING!

A non-functioning battery must be handled with caution. The battery state of charge and risk of venting may be unknown. Contact SolarEdge for assistance.



WARNING!

Do not attempt to remove or transport a damaged or non-functioning battery. Contact SolarEdge or your SolarEdge certified installer for support.



WARNING!

Do not dispose of this product with general household waste. Consult your local regulations for proper disposal instructions.

Installation Tools

Make sure you have the following tools, before starting the installation:

- Crimping tool
- Torque wrench
- Drilling machine
- Level
- Phillips screwdriver
- Flat-blade screwdriver
- Cable cutter
- Wall plugs and screws
- Hammer

Charging cable requirements

- Conductor cross section - 35mm^2
- Outer diameter 14-21mm
- maximum cable length 5m

What's in the Package

- Battery module
- Mounting bracket
- 2 x M5 screws

Battery accessories

SOLAREEDGE HOME BATTERY - ACCESSORIES (PURCHASED SEPARATELY)	
DESCRIPTION	PN
Accessory SolarEdge Home Battery 48V , mechanical top cover (1 required per tower)	IAC-RBAT-5KMTOP-01
Accessory SolarEdge Home Battery 48V to SolarEdge Home Hub Inverter – Three Phase (PN SE*K-RWS48)	IAC-RBAT-5KCINV-01
Accessory SolarEdge Home Battery 48V cable set SolarEdge Home Battery 48V to SolarEdge StorEdge Inverter –Three Phase (PN SE*K-RWS48)	IAC-RBAT-5KCINV-02
Accessory SolarEdge Home Battery 48V , cable set battery module to battery module	IAC-RBAT-5KCBAT-01
Accessory SolarEdge Home Battery 48V , cable set tower to tower	IAC-RBAT-5KCTOW-01
Floor stand support SolarEdge Home Battery 48V (optional)	IAC-RBAT-5KFSTD-01
Accessory 10 * Spare connector kit for battery to Inverter connection, SolarEdge Home Battery 48V	IAC-RBAT-5KCNCT-01
Accessory 10 * Spare connector kit for tower to tower connection, SolarEdge Home Battery 48V	IAC-RBAT-5KCNCT-02

Selecting and Preparing the Installation Site

Make sure to observe the following requirements, when selecting an installation site.

Configurations

The term *Battery module* refers to a single battery. The term *Battery Tower* or *Tower* refers to a number of modules stacked on top of each other and connected in parallel. The term *Battery pack* or *Battery* refers to all the battery modules connected to each other and to the same inverter, in one or two towers.

Connect up to 5 battery modules in two towers (maximum 3 in a tower).

Content	PN	Number of Towers						
		1			2			
		1 battery	2 batteries	3 batteries	2 batteries	3 batteries	4 batteries (3+1 or 2+2)	5 batteries (3+2 or 4+1)
Battery pack with	BAT-05K48M0B-01	1	2	3	2	3	4	5
Tower cover with 5 screws	IAC-RBAT-5KMTOP-01	1	1	1	2	2	2	2
Battery to battery cable kit (same tower)	IAC-RBAT-5KCBAT-01	0	1	2	0	1	2	3
Tower to tower cable set	IAC-RBAT-5KCINV-01	0	0	0	1	1	1	1
Battery to inverter cable set	IAC-RBAT-5KCTOW-01	1	1	1	1	1	1	1
Floor support stand(recommended)	IAC-RBAT-5KFSTD-01	1	1	1	2	2	2	2

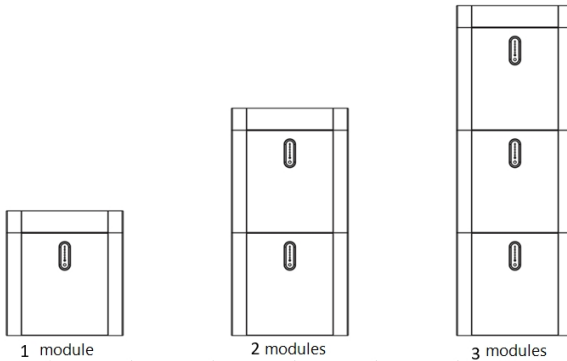

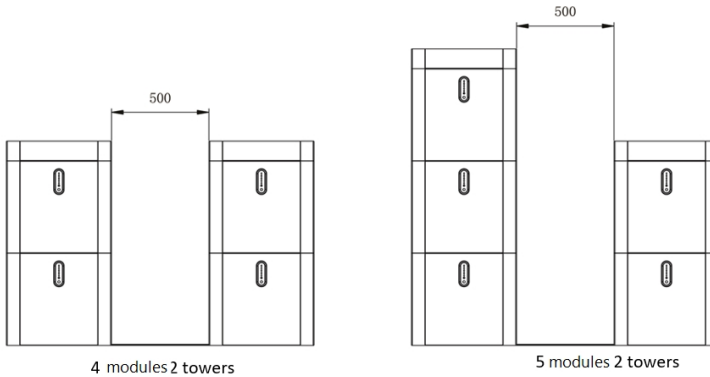

Figure 1: Battery Pack Configurations

General Guidelines and Requirements

- The battery may be installed in an outdoor or indoor location.
- Since the battery must be secured to a wall using the supplied mounting bracket, the installation location must be adjacent to a wall.
- When installed indoors, the battery must not be obstructed by any building structure, room furniture or equipment.
- The battery shall not be exposed to direct sun or rain.
- Since the battery has natural convection, the installation site must be clean, dry and well ventilated.
- The installation location must allow easy access to the battery for installation and maintenance.
- The front panel or battery module should not be covered.

Restricted Locations

Do not install the battery at any of following locations:

- residential rooms
- wall or ceiling niches
- entrance/exit areas or below a staircase/passage
- environments with humidity and condensed water level of over 90%
- earthquake zones where additional safety measures are required

- sites at altitudes of more than 2000 meters above the sea level
- sites exposed to direct sunlight or sites where the ambient temperature may exceed the specified maximum temperatures
- near flammable materials or gases or explosive environments

Clearance

Observe the following minimum clearance:

- 20 cm from all sides of the battery module.
- 30 cm from another battery module or any heat source, such as water heater unit, gas-fueled heater, air conditioning unit or any other equipment
- 100 cm from emergency exits
- 30 cm from doors
- 25 cm from windows
- 20 cm from air vents
- 20 cm from other devices

WARNING!



Connect no more than 5 batteries per inverter. Use no more than 3 batteries per battery tower.



NOTE

The distance between the battery tower and

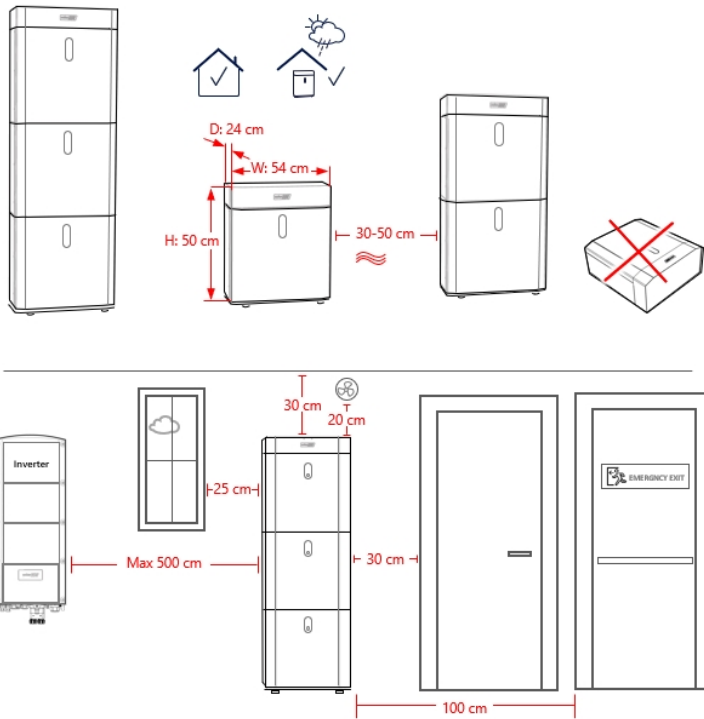

Figure 2: Clearance

Note the following dimensions:

	Width	Height	Depth
Battery module	540mm	500mm	240mm
Tower Cover	540mm	120mm	240mm
Floor Stand	535mm	50mm	210mm

Residential Barrier

In order to prevent a fire from spreading, install a non-combustible barrier on the other side of the wall or structural surface, on which the battery is installed. If the installation surface is not made of a non-combustible material, a non-combustible barrier can be installed between the battery and the wall or structural surface.

If the Battery pack is installed on a wall or at a distance of 300mm from the wall that isolates the energy storage system from a residential space, the distance from other structures or objects must be increased.

Installing the Battery Modules

Battery description

Figure below shows the single battery module with completed connections.

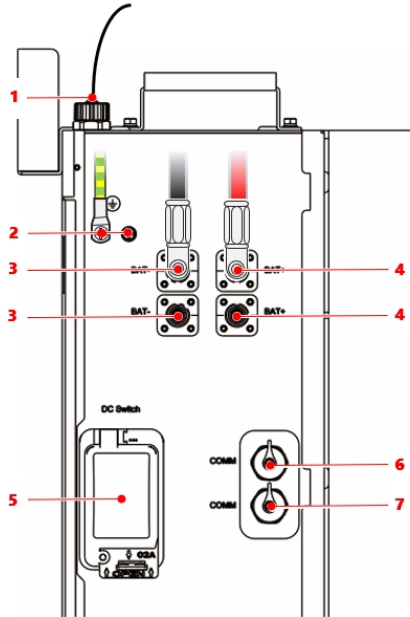

Figure 3: Battery Description

1	CAN-bus (RJ45) connection to inverter communication	5	Circuit breaker, 120A
2	Grounding terminals	6	RJ45 communication socket to connect between battery modules. <u>Not to be used to inverter communication.</u>
3	DC bat - connectors	7	RS485 Communication socket to connect the battery module below to this battery module (in a battery tower)
4	DC bat + connector		

Installation procedure

1. Install a floor stand.

Floor stand is optional, however, for durable and robust insulation, SolarEdge recommends to install the battery modules on top of a floor stand, to be purchased separately from SolarEdge. Depending on wall leveling, consider when installing more than one module.

- a. Place the floor stand at a distance of 3-5cm from the wall.

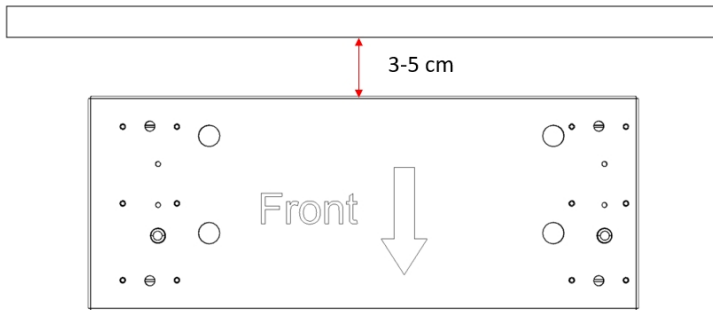

Figure 4: Floor stand placement



NOTE

The arrow should point at the battery module front.

- b. To level the floor stand, adjust each of the four legs by turning the screw using a flat screwdriver.

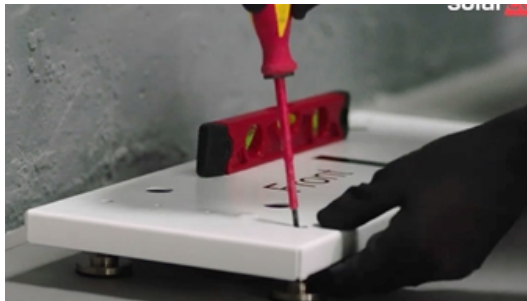

Figure 5: Floor stand leveling

- c. When the floor stand is balanced, tighten the nut with an open wrench in order to secure the leg's height, then tap it.



Figure 6: Floor stand—tightening the nut

CAUTION!

Before moving the battery module to its location, make sure that both the CB switch and the power button (soft switch) of the battery module are off – refer to *Connecting a Single Battery Module* on page 20.

2. Take the battery module out of the box, move it to the installation location. You can use the battery handles located at the top of the battery for convenience of moving and placing it on the the right position.
3. Place the battery module on the floor stand using the top handles. Make sure that the battery stands firmly, and not shaky, on the floor stand.

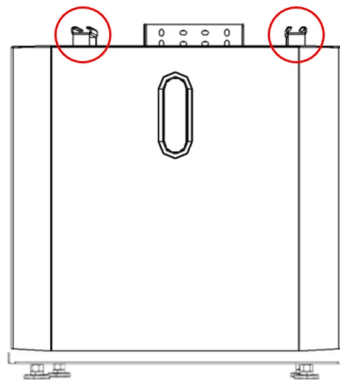

Figure 7: Top handles

- Put the bracket on the wall, mark the drilling holes location, then remove the bracket and drill holes in the wall.

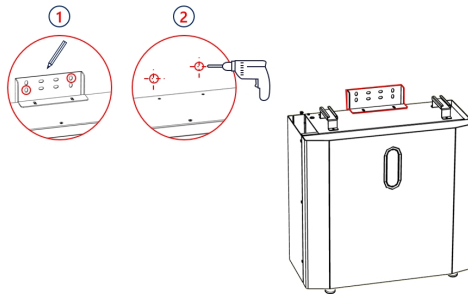

Figure 8: Drilling the holes for the wall bracket



NOTE

Don't drill through the bracket.

- Assemble the supplied mounting bracket to the battery module using two M5 screws. Tighten the screws to a torque of 2.5Nm.



NOTE

For better cable routing, use the mounting bracket oval hole in a way to enable the maximum available distance between the battery module and the wall.

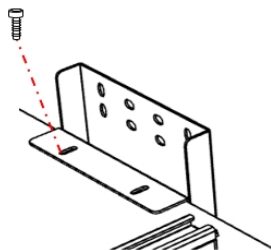

Figure 9: Setting the distance from the wall

- Secure the battery module to the wall with screws and wall plugs. When using only two screws, make sure to use the two outer screws diagonally as shown on the figure below.

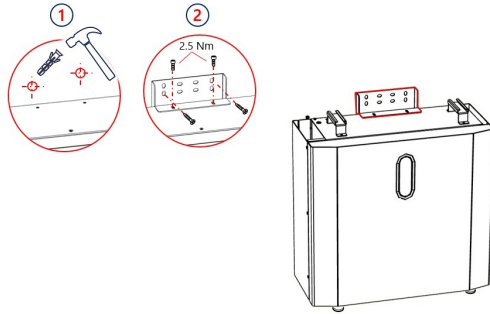

Figure 10: Connecting the mounting bracket

7. When installing battery modules in a tower configuration (one on top of the other):
 - Before securing the wall brackets, make sure the battery modules are aligned (see the figure below).
 - Secure all battery modules to the wall as described above.
 - Note that the maximum allowed amount of battery modules in a tower is three.

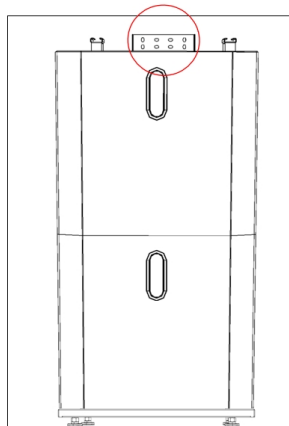

Figure 11: Installing battery modules in a tower configuration

Connecting a Single Battery Module



If you are installing a single battery module, connect it to the inverter as follows:

1. Make sure the battery module's DC switch is off.
2. Before connecting the cables between the towers and the inverter, make sure the accessory kit is of the correct length (see below).



CAUTION!

Note the following cable parameters, it is extremely important for durable installation as the current flowing through the cables may exceed 100A.

PN	Type	Cable length		
		DC	Ground	Communication
IAC-RBAT-5KCINV-01 (to Hub Inverter) IAC-RBAT-5KCINV-02 (to Wave Inverter)	Battery Pack To Inverter	57 	55 	57 
IAC-RBAT-5KCTOW-01	Tower to Tower	260	170	170
IAC-RBAT-5KCBAT-01	Module to Module (Same Tower)	260	260	260

If you need a longer cable, you will have to crimp the connectors yourself using one of the following kits:

IAC-RBAT-5KCNCT-01	10 DC connectors (red) – battery side 10 DC connectors (black) – battery side 10 RJ45 connectors – inverter side 10 waterproof RJ45 – connectors
IAC-RBAT-5KCNCT-02	20 DC connectors (red) 20 DC connectors (black) 20 waterproof RJ45 connectors

3. Release the three screws and slide the left side door, that covers control interfaces on the left side of the battery module, to allow clear and secure access to the battery module interfaces.

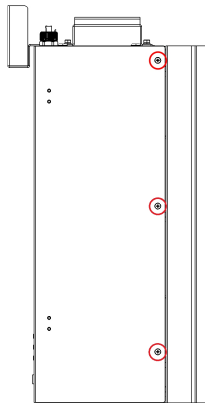

Figure 12: Access to the left side interfaces

4. Before continuing with the installation, make sure the battery is OFF, then make sure that the front panel LEDs are OFF. If the battery is on, first turn OFF the CB, then the soft switch, as follows:

- a. To turn off the battery module circuit breaker, remove the cover screw, click the door open, turn off the circuit breaker.

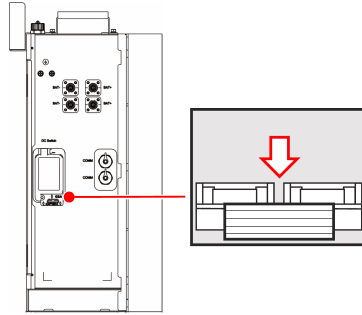

Figure 13: Turning off the circuit breaker

- b. Press the power button (soft switch, position 4 below) for 3-6 seconds until the indicator lights go out.

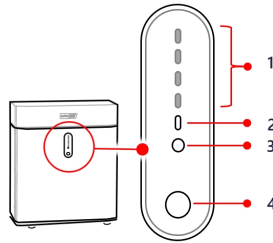

Figure 14: Battery LED indicators

1	Battery Capacity/ Alarm ID
2	Indication LED
3	Operation Indicator
4	Power/Reset Button

5. Connect the CAN-bus communication cable (RJ45) coming from the inverter, with the top battery module connector marked "Inverter". It is important to distinguish between the inverter communication port and any other module to module communication ports.

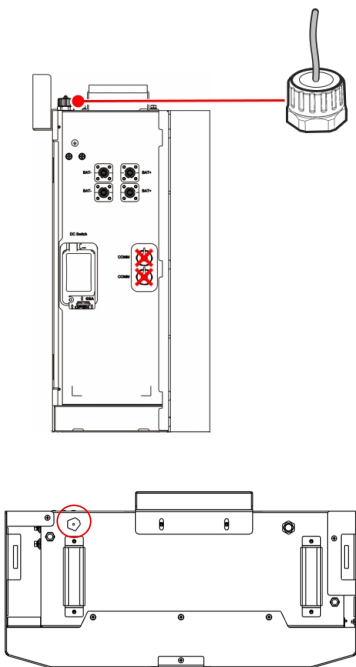

Figure 15: Connecting the communication cable

- Use the left grounding terminal to connect the battery module, depending on the local regulation, to the inverter grounding or to the main grounding.

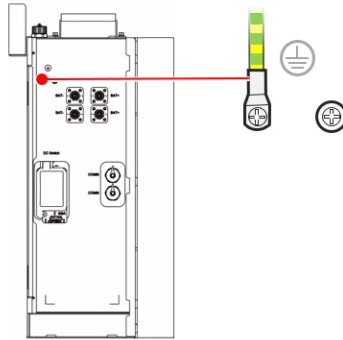

Figure 16: Connecting the grounding terminal

- Make sure the Inverter is turned off, then use the upper pair of DC connectors (BAT- and BAT+) to connect power from the inverter. Note the polarity. Insert the connectors into this socket until you hear a click.

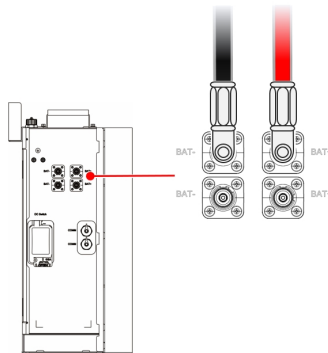

Figure 17: Connecting power from the inverter

- Figure below shows the single battery module with completed connections.

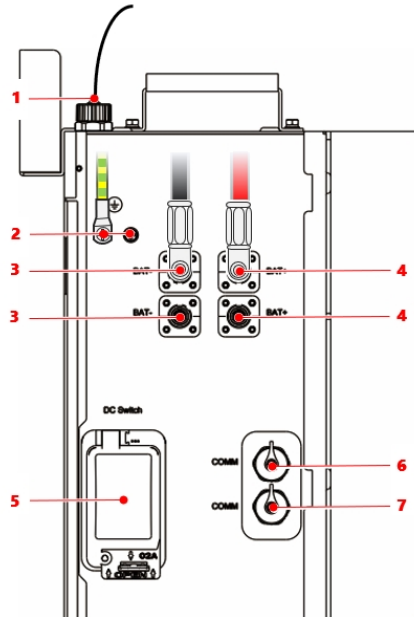

Figure 18: Single battery module connections.

1	CAN-bus (RJ45) connection to inverter communication	5	Circuit breaker, 120A
2	Grounding terminals	6	RJ45 communication socket to connect between battery modules. NOT TO BE USED to inverter communication.
3	DC bat - connectors	7	RS485 Communication socket to connect the battery module below to this battery module (in a battery tower)
4	DC bat + connector		

9. Using the power button (soft switch), turn on the battery modules, refer to *Powering on the Battery Module* on page 29. Press the power button (soft switch) shown on the figure below for 3-6 seconds, the LEDs will light. If this is a new battery (e.g. not RMA) only the first green LED or the first and second green LED should light constantly. No other LEDs should light. If you observe a different LEDs sequence,

refer to for LED troubleshooting, or contact SolarEdge support with the Battery module SN and the LED sequence. Until this is solved, do not proceed with the installation.

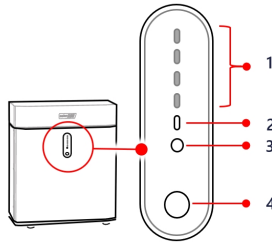

Figure 19: Battery LED indicators

1	Battery Capacity/ Alarm ID
2	Indication LED
3	Operation Indicator
4	Power/Reset Button

CAUTION!



Before turning on the battery module circuit breaker, make sure that the cables to the inverter are connected, with the DC cables, to the inverter at the right polarity. Failing to do so, may cause either the battery or the inverter to malfunction.

10. Turn on the battery module circuit breaker.
11. Close the side door and route all the cables above the door.
12. After turning on the CB, you will be able to fasten the side door with the three screws.

Connecting Multiple Battery Modules

**CAUTION!**

Before connecting additional modules, make sure the CB and the LEDs are OFF on all the modules.

When installing multiple battery modules, connect them in parallel.

**CAUTION!**

Use only cables recommended by SolarEdge—see *Connecting a Single Battery Module* on page 20

Contact SolarEdge or your distributor to order the appropriate cable kit for your configuration. For cable kits and accessories, see *What's in the Package* on page 9.

1. Open the side doors of the battery modules.
2. Turn off the power button (soft switch) in all battery modules.
3. Connect the DC, communication and grounding cables between the battery modules as shown below (example; your actual configuration may differ).

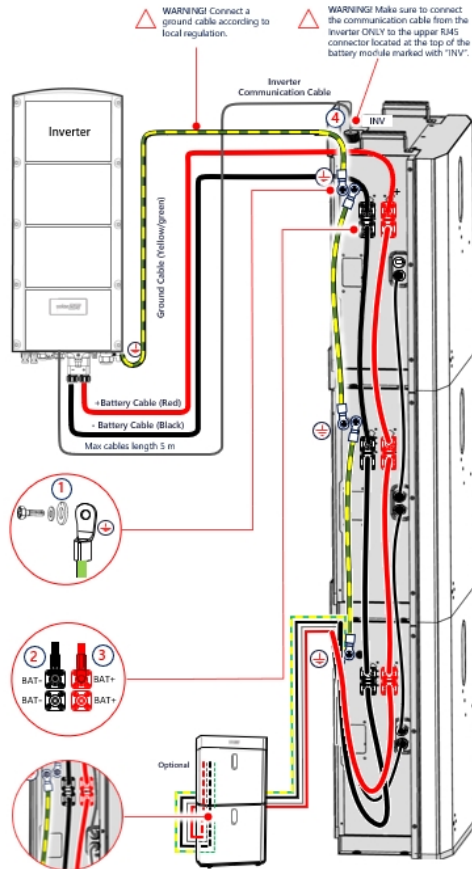

Figure 20: Connecting cables between the battery modules

4. Connect the DC and communication cable of the first or last battery module to the inverter. For ease of installation, SolarEdge recommends to connect the inverter to the top battery module. See the inverter installation guide for connection instructions.

NOTE

When you have multiple battery modules on top of each other, they are connected in a way that the top connectors of the lower battery module are connected to the bottom connectors of the upper battery module.

Powering on the Battery Module

1. Press the power button for 3-6 seconds until the indicator lights are on.

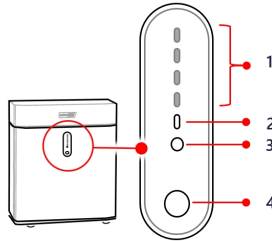

Figure 21: Battery LED indicators

1	Battery Capacity/ Alarm ID
2	Indication LED
3	Operation Indicator
4	Power/Reset Button

2. Turn on the DC switch.

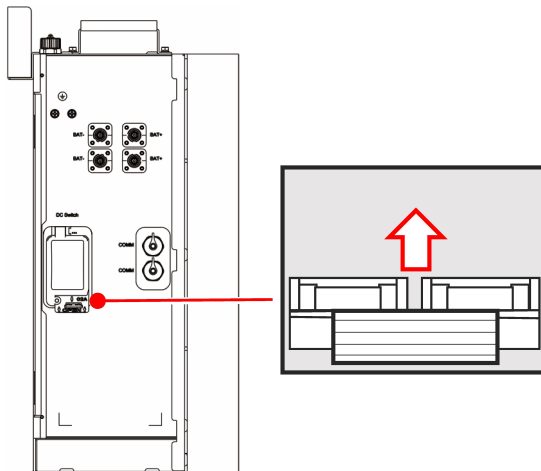

Figure 22: Turning on the DC switch

3. Fasten the side door with the three screws.

Top Cover Installation

After installing the battery and making all the connections, install the top cover on the top battery module in every tower.

1. Take the top cover out of its box
2. Remove the top plate screws
3. Place the frame on top of the top battery module in the tower, secure it with the 3 screws provided in the kit
4. Assemble the top plate with the 5 screws.

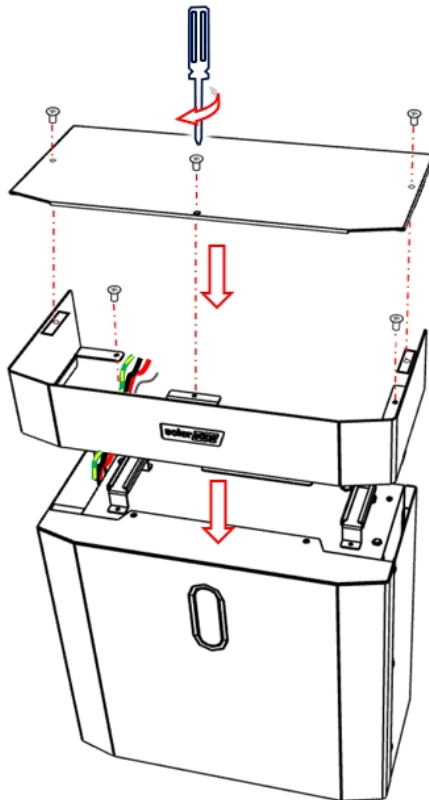

Figure 23: Top Cover Installation

Adding or Removing a Battery Module

It is better to install the battery when there is enough PV to charge the battery pack after adding the module.

Before adding or removing a battery module:

1. Make sure to turn off the CB and the power button (soft switch) on every battery module, see *Connecting a Single Battery Module* on page 20.
2. Make sure to turn the inverter OFF.



WARNING!

Adding or Removing a Battery Module while the inverter is ON may cause injury, hazard shock, and damage to the battery.







3. Make sure that the battery pack SoC is between 25-75% (1-3 LED are green).
4. Follow the procedure *Installing the Battery Modules* on page 15, then *Connecting a Single Battery Module* on page 20.
5. Power on the battery module, see *Powering on the Battery Module* on page 29.







The added module may have different SoC level than the existing modules, this is normal and will be balanced after a few charge/discharge cycles .

LED Indications

The following section describes the LED behavior of the SolarEdge Home Battery 48V.

Mode	Behavior
Normal operation of the battery	Operational LED is ON or Blinking once NO other cases of operational LED
Alarm – there is an alarm, but battery still function	Operational LED blinks 3 times, Fault is OFF
Protection – battery have limited operation	Operational LED blinks 3 times, Fault is ON

Battery status	Mode of operation	Operation LED	Fault LED	Battery Level Indicator LED			
							
OFF	Hibernation	Off	Off	Off	Off	Off	Off
Normal	Idle	1 blink	Off	Indicates battery SoC level			
	Charge	On	Off	Indicates battery SoC level			
	Discharge	On	1 blink	Indicates battery SoC level			

Battery status	Mode of operation	Operation LED	Fault LED	Battery Level Indicator LED			
							
Alarm	Module over voltage	3 blinks	Off	On	On	On	On
	Module Under voltage	3 blinks	Off	On	On	On	Off
	Cell over voltage	3 blinks	Off	On	On	Off	On
	Cell under voltage	3 blinks	Off	On	On	Off	Off
	Charge MOS fault	3 blinks	Off	On	Off	On	On
	Discharge MOS fault	3 blinks	Off	On	Off	On	Off
	Cell over temperature	3 blinks	Off	On	Off	Off	On
	Cell under temperature	3 blinks	Off	On	Off	Off	Off
	Charging Over Current	3 blinks	Off	Off	On	On	On
	Discharge Over Current	3 blinks	Off	Off	On	On	Off
	Cell sampling fault	3 blinks	Off	Off	On	Off	On
	Heating fault	3 blinks	Off	Off	On	Off	Off
	Low SoC	3 blinks	Off	Off	Off	On	On
	Temperature sensor malfunction	3 blinks	Off	Off	Off	On	Off
	Battery Cell malfunction	3 blinks	Off	Off	Off	Off	On
	Communication failure	3 blinks	Off	Off	Off	Off	Off

Battery status	Mode of operation	Operation LED	Fault LED	Battery Level Indicator LED			
Protection	Short Circuit	3 blinks	On	On	On	On	On
	Charge	3 blinks	On	On	On	On	Off
	Module Over Voltage	3 blinks	On	On	On	Off	On
	Module Over current	3 blinks	On	On	On	Off	On
	Module Over voltage	3 blinks	On	On	On	Off	Off
	Module Under voltage	3 blinks	On	On	Off	On	On
	Reverse Polarity	3 blinks	On	On	Off	On	Off
	Cell Over voltage	3 blinks	On	On	Off	Off	On
	Cell Under voltage	3 blinks	On	On	Off	Off	Off
	Cell Over Temperature	3 blinks	On	Off	On	On	On
	Charge/Discharge	3 blinks	On	Off	On	On	Off
	Cell Under Temperature	3 blinks	On	Off	On	On	Off
	Charge/Discharge	3 blinks	On	Off	On	Off	On
	Ambient Over Temperature	3 blinks	On	Off	On	Off	On
	Ambient Under Temperature	3 blinks	On	Off	On	Off	Off
	Mosfet Over Temperature	3 blinks	On	Off	Off	On	On
	Reserved	3 blinks	On	Off	Off	On	Off
	Reserved	3 blinks	On	Off	Off	Off	On
	Battery Locked	3 blinks	On	Off	Off	Off	Off

Blink Mode	On	Off
Blinks once every 4 seconds	0.25S	3.75S
Blinks three times every 6 seconds	0.5S	1.5S

Support Contact Information

If you have technical problems concerning SolarEdge products, please contact us:



<https://www.solaredge.com/service/support>

Before contact, make sure to have the following information at hand:

- Model and serial number of the product in question.
- The error indicated on the SetApp mobile application, LCD screen, on the monitoring platform, or by the LEDs, if there is such an indication.
- System configuration information, including the type and number of panels connected and the number and length of strings.
- The communication method to the SolarEdge server, if the site is connected.
- The product's software version as it appears in the ID status screen.

solaredge