

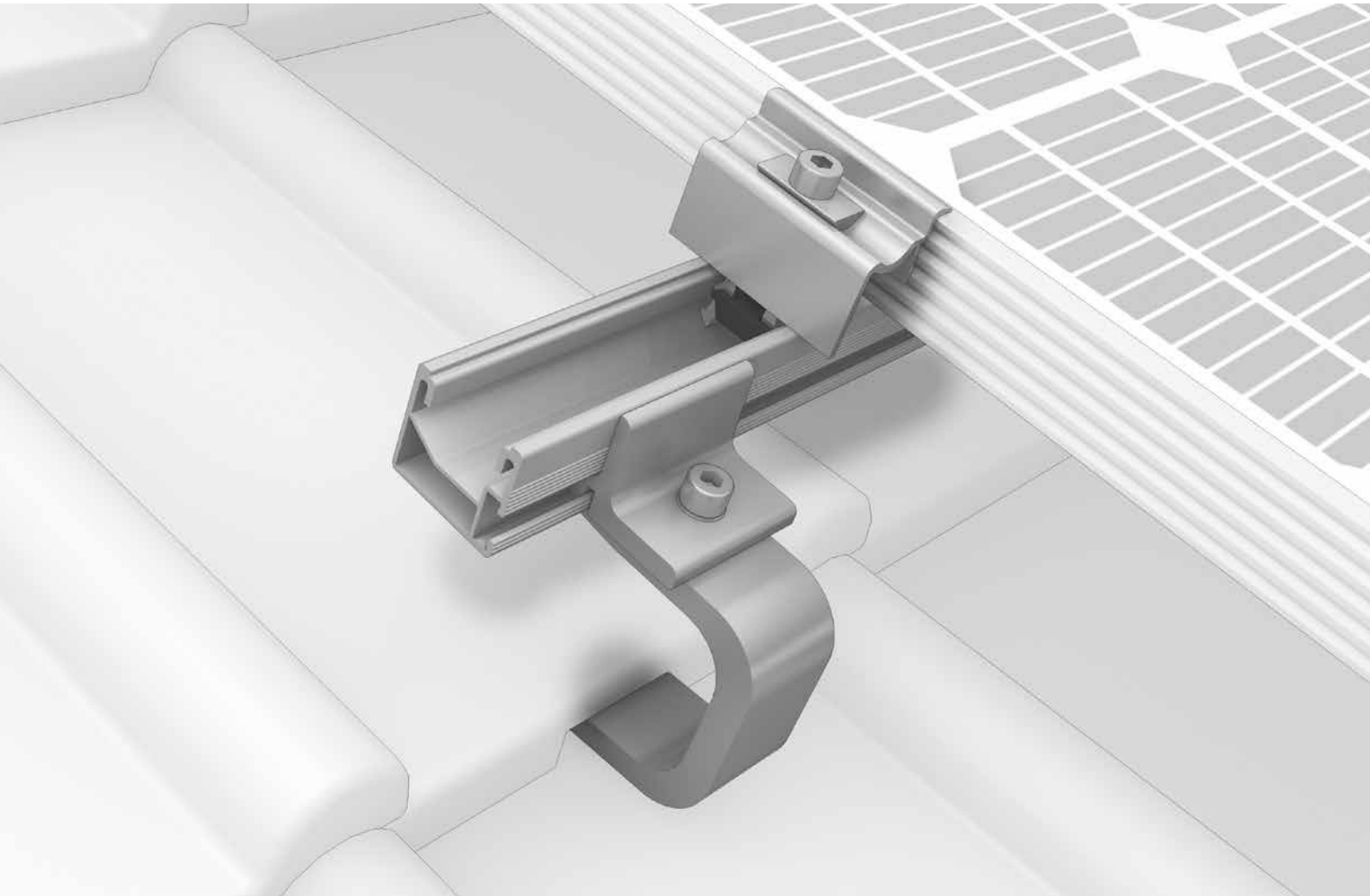

# SingleRail System



- / Quick and low-cost with direct lateral connections to the rail including customised height adjustment
- / Secure snap-in assembly - without needing to be screwed into the base plate
- / The SingleRail in combination with CrossHook roof hooks is very durable and versatile



# Roof fastenings

## Aluminium roof hooks

- / Optimum force transmission, can also be used on narrow rafters and direct connection to SingleRail
- / 80 % of all roof tiles and roofing stones covered
- / Simple height adjustment on base plate, extension arm or on slotted hole connection
- / CrossBoard/SingleBoard for rafter change
- / CrossHook 3S: With European construction approval ETA-16/0709



## Stainless steel roof hooks

- / High-quality, thin stainless steel outriggers and partly direct connection to SingleRail
- / For roof tiles, flat and pantiles
- / Height adjustable or many precisely fitting roof hooks with adapter connection from the SolidHook range

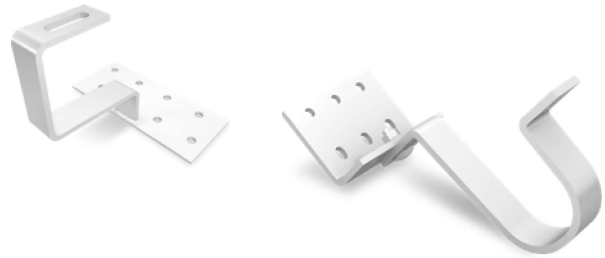

## Hanger bolts

- / For all corrugated fiber cement and corrugated sheet metal coverings with wooden substructure
- / Secure sealing at the roofing
- / With Climber connection
- / With German building authority approval [abZ]



## Sheet metal folding clamps

- / Many application possibilities: Double standing seam, angled seam, snap seam and round seam
- / Direct lateral rail connection
- / Penetration-free mounting

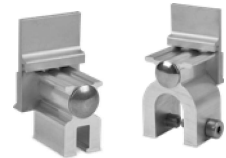

# Technical data

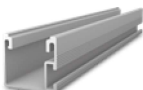
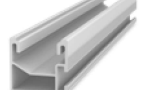
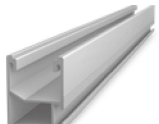
SingleRail	Light 36	36	50
Figure			
Material	Aluminium [EN AW-6063 T66]		
W = width [mm]	39.4	39.4	39
H = height [mm]	36	36	50
Lengths [m]	4.40	2.10 / 2.25 / 3.30 / 4.40 / 5.50	4.40
Weight [kg/m]	0.67	0.76	1.0
Second rail layer	SingleRail or SolidRail		

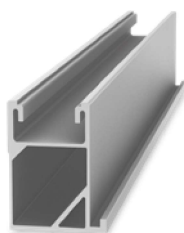
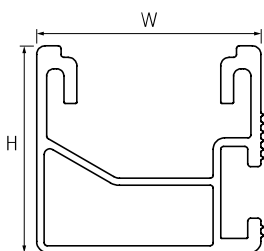

**SingleRail 63:** For heavy loads and large spans!