



Surge Protection

Catalogue valid as of October 1, 2018



DEHNshield® ... Basic 29-32



- Application-optimised and prewired spark-gap-based type 1 + type 2 combined lightning current and surge arrester
- Space-saving spark gap technology with a width of only 1 module/pole
- Fulfills the minimum requirements on the lightning current discharge capacity according to IEC 60364-5-53 for residential buildings without external lightning protection, for converters with voltage peaks (e.g. in wind turbines)

DEHNgard® SE CI (WE) 440 FM 60



- Single-pole surge arrester with integrated backup fuse for higher voltage 440 V
- Optimal performance due to ideally designed integrated surge-proof fuse
- Type WE with 750 V varistor rated voltage; ideally suited for converters with peak voltages (e.g. in wind turbines)

DEHNcord R 3P 275 82



- Surge arrester for electric Venetian blinds
- Standard adapter design requires no tool for installation
- Acoustic fault indication with interruption of the load current circuit in the event of a fault for downstream operation

DEHNgard® M YPV 1200 (1500) FM 86



- Multipole, modular surge arrester for PV systems up to 1170 V (1500 V) DC; with remote signalling contact
- Fulfills the requirements of EN 50539-11
- KEMA and UL approval

DEHNgard® M PV2 SCI SN1868 FM 89



- Multipole, modular surge arrester with three-step DC switching device for protecting 3 MPP inputs, for use in PV systems
- Fulfills the requirements of EN 50539-11
- KEMA and UL approval

DEHNrail M 2(4)P 255 SN ... (FM) 105



- Modular surge arrester
- Usable for systems up to 32 A load current (no through-wiring)
- High discharge capacity due to heavy-duty zinc oxide varistor/spark gap combination

STAK 3X16 Pin-shaped Terminal 120



- Allows series connection (connection of three conductors) of surge protective devices up to 16 mm²
- Allows EMC-optimised through-wiring according to IEC 60364-5-53

BLITZDUCTOR® XT Protection Module M2 BD HC5A 24 164



- Multipole, modular surge arrester with three-step DC switching device for protecting 3 MPP inputs, for use in PV systems
- Fulfills the requirements of EN 50539-11
- KEMA and UL approval

DEHNpipe MD EX 24 N 2 199



- Surge arrester to be screwed onto field devices with NPT thread
- Through-wiring protection for intrinsically safe circuits and bus systems
- Meets FISCO requirements

DEHNpatch CLE IP66 203



- Surge arrester for Ethernet in outdoor applications
- Power over Ethernet (PoE+ according to IEEE 802.3at)
- Enclosure in IP66 degree of protection with universal support for pole/wall mounting

DEHNgate FF5 TV 220



- Compact surge arrester for satellite systems
- Optimal five-channel protection for 75 Ohm antenna splitters and multi-switches
- Fulfills the shielding requirements of class A acc. to EN 50083-2

DEHNrecord Alert AL MODBUS / MCM AL XT 233



- Modbus TCP/RTU communication module
- Integration of Red/Line and Yellow/Line SPDs into a monitoring system
- Monitoring of up to 4 surge arresters with remote signalling contacts and up to 150 BLITZDUCTOR XT arresters (RS 485)



Foreword	3
New Products	Cover
Our Promise – DEHN protects.®	3
DEHN – International	4
Planned Safety	5
Terms and Definitions / Definition of Symbols	9
Protection Solutions for Buildings	14

Services	13
DEHNselect SPD Tool – Planning of internal Lightning Protection and Surge Protection	13



Surge Protection for Power Supply Systems	Red / Line®	17
Combined Arresters – Type 1 + Type 2		20
Lightning Current Arresters – Type 1		35
N-PE Lightning Current Arresters		51
Surge Arresters – Type 2		54
Surge Arresters – Type 3		103
General Accessories		119
Outdated Products		128



Surge Protection for Information Technology Systems	Yellow / Line	129
Easy Choice according to Interface / Signal		135
Pluggable SPDs – DIN Rail mounted		157
Terminal Block SPDs – DIN Rail mounted		177
Compact SPDs – DIN Rail mounted		181
SPDs for LSA Technology		187
SPDs for Field Devices		197
SPDs for Telecommunication and Data Networks		203
SPDs for Building Systems		209
SPDs for Coaxial Connection		217
SPDs for SUB-D Connection		223
Shield Connection Systems and Enclosures		225
Measuring and Test Devices		231
Outdated Products		237



Lightning Equipotential Bonding	239
Isolating Spark Gaps	240
Voltage Controlled Short-Circuiting Device	245
Ex Pipe Clamps	247
Voltage Limiters	249
Equipotential Bonding	253

Index	261
DEHN – informativ / DEHNacademy – E-Learning / Notes	261
Publications of the DEHNgroup / References	262
Part No. Index / Type Index	265
Notes	275
Key Words	276

Surge Protection Main Catalogue valid as of October 1, 2018

This catalogue replaces the Surge Protection Main Catalogue 2017.

We reserve the right to introduce changes in configuration and technology, dimensions, weights and materials within the scope of technical progress. Illustrations are not binding. We accept no liability for misprints, modifications and errors. Any reproduction of this catalogue, as a whole or in parts, is only allowed upon approval of DEHN + SÖHNE.



Our promise



“We are a reliable partner for our customers and employees.”

Dr. Philipp Dehn
Managing Partner / CEO

DEHN protects.®

Dear customers, friends, partners,

Every facet of life, whether business or private, is today highly complex. In order to cater to your ever increasing needs we provide innovations and manifold new products. We offer comprehensive protection solutions which, obviously, go hand in hand with the appropriate service. The key to the implementation of protection solutions for our and your own customers is in-depth and comprehensive consultation. Extended services and improved processes help both you and us to transform requirements into possibilities. We would like you, as our partner, to link up your protection requirements and needs with our services and expertise, in order for us both to reap the mutual advantages. Our new and constantly evolving protection concepts are designed to make your daily life and surroundings safer.

Of course, we also continue to provide all of DEHN's traditional, reliable products and safety solutions. We aim to be your safety partner worldwide for surge and lightning protection and safety equipment. Effective protection against the risks presented by lightning and surges for people and equipment is our business. A feel for the market, determination and ideas are the lifeblood for new safety products and concepts. This is the main focus of our family business and has, coupled with the pioneering spirit and innovation which have been our trademark for more than 100 years, made us a market leader with about 1800 employees.

The hub of our activities is in Neumarkt in Bavaria, Germany. It is here that developers work with project and product managers to further advance our protection technology. And it is here that we produce your safety products. Every day we endeavour to ensure that your business can continue to grow thanks to our innovative solutions and services. The DEHN brand name stands for innovation, consistent customer and market orientation and the highest possible quality. Now and in the future.

Take advantage of our range of surge and lightning protection and safety equipment and join us in providing a tad more safety.

I look forward to your interest and future cooperation with you.

Dr. Philipp Dehn



"Our customers are the focal point of our activities."

Helmut Pusch
Managing Director / CSO

Fair partnership for the best solution

Our goal is to be a reliable and fair partner for our industrial, commercial and technical customers all over the world. To this end, we always focus on the best protection solution.

Our sales teams in our global network in Germany, in our 20 subsidiaries and offices as well as more than 70 international partners ensure the competent and customer-oriented marketing of our products. Proximity to and close contact with our customers is of great importance to us, be it on-site support by our experienced team, our telephone hotline or personal contact at trade fairs. In hundreds of seminars, workshops and conferences held every year throughout the world, we impart practical knowledge on our products and solutions based on specific sample applications, technical and physical correlations and standardisation.

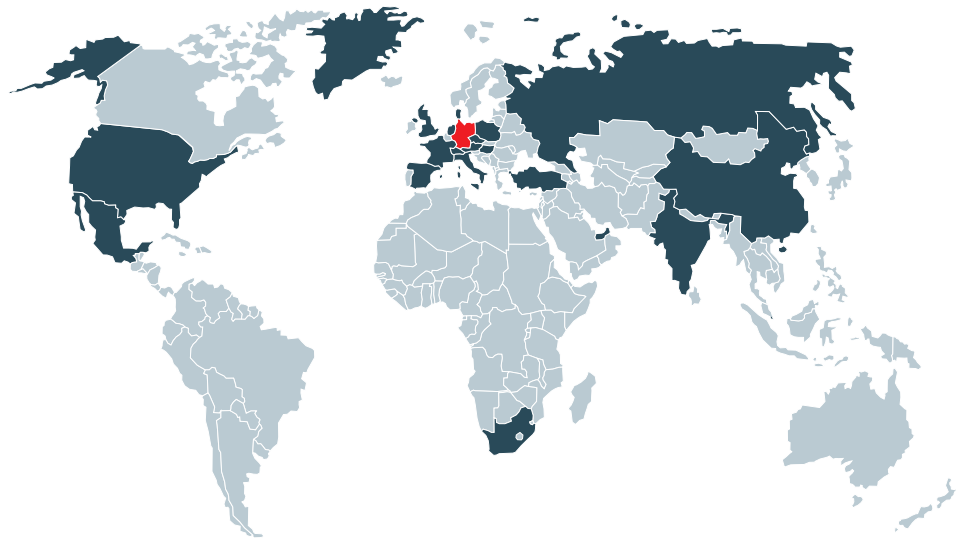

DEHN + SÖHNE GmbH + Co.KG.

Customer Service Center

Commercial customer service
sales@dehn.de
Phone +49 9181 906 1547
Fax +49 9181 906 1444

Technical Support
itss@dehn.de
Phone +49 9181 906 1774
Fax +49 9181 906 1444

Subsidiaries and representative offices

Austria:	DEHN AUSTRIA GmbH	www.dehn.at
China:	DEHN Surge Protection (Shanghai) Co. Ltd.	www.dehn.cn
Czech Republic:	DEHN office Prague	www.dehn.cz
Denmark:	DESITEK A/S	www.desitek.dk
France:	DEHN FRANCE S.à.r.l.	www.dehn.fr
Great Britain:	DEHN (U.K.) LTD.	www.dehn.co.uk
Hungary:	DEHN office Budapest	www.dehn.hu
India:	DEHN INDIA Pvt. Ltd.	www.dehn.in
Italy:	DEHN ITALIA S.p.A.	www.dehn.it
Mexico:	DEHN PROTECTION MÉXICO, S.A. de C.V.	www.dehn.mx
Netherlands:	DEHN NEDERLAND B.V.	www.dehn.nl
Poland:	DEHN POLSKA Sp. z o.o.	www.dehn.pl
Russia:	OOO DEHN RUS	www.dehn-ru.com
Singapore:	DEHN (SEA) PTE. LTD.	www.dehn.sg
South Africa:	DEHN AFRICA (Pty) Ltd.	www.dehn-africa.com
Spain:	DEHN IBÉRICA Protecciones Eléctricas, S.A. Unipersonal	www.dehn.es
Switzerland:	ELVATEC AG	www.elvatec.ch
Turkey:	DEHN office Istanbul	www.dehn.com.tr
United Arab Emirates:	DEHN MIDDLE EAST FZE	www.dehn.ae
USA:	DEHN Inc.	www.dehn-usa.com

Sales activities in more than 70 countries worldwide

You can find your current local contact person on the Internet at:
<http://www.dehn-international.com/en/contact>

Failure of technical installations and systems in residential and functional buildings is very unpleasant and expensive. Therefore, faultless operation of devices must be ensured both during normal operation and thunderstorms. The number of annually registered lightning activities in Germany maintained at a constantly high level over many years. Damage statistics of insurance companies clearly show that there are deficits in terms of lightning and surge protection measures both in the private and commercial sector (Figure 1).

A professional solution allows to take adequate protection measures. The lightning protection zone concept, for example, enables designers, constructors and operators of buildings and installations to consider, implement and monitor different protection measures. All relevant devices, installations and systems are thus reliably protected at a reasonable expense.

Sources of interference

Surges occurring during a thunderstorm are caused by direct/nearby lightning strikes or remote lightning strikes (Figure 2 and Figure 3). Direct or nearby lightning strikes are lightning strikes to a building, its surroundings or electrically conductive systems entering the building (e.g. low-voltage supply, telecommunication and data lines). The resulting impulse currents and impulse voltages as well as the associated electromagnetic field (LEMP) are particularly dangerous for the devices and installations to be protected with regard to the amplitude and energy content involved. In case of a direct or nearby lightning strike, surges are caused by the voltage drop at the conventional earthing impedance R_{St} and the resulting potential rise of the building in relation to the remote earth (Figure 3, case 2). This means the highest load for electrical installations in buildings.

The characteristic parameters of the impulse current present (peak value, rate of current rise, charge, specific energy) can be described by means of the 10/350 μs impulse current wave form. They have been defined in international, European and national standards as test current for components and devices protecting against direct lightning strikes (Figure 4).

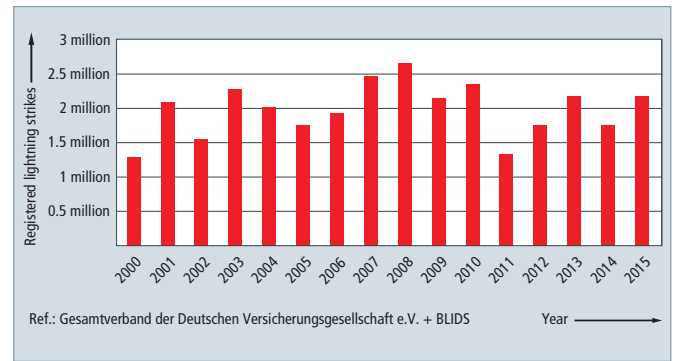

Figure 1: Lightning activity registered in Germany from 2000 to 2015.

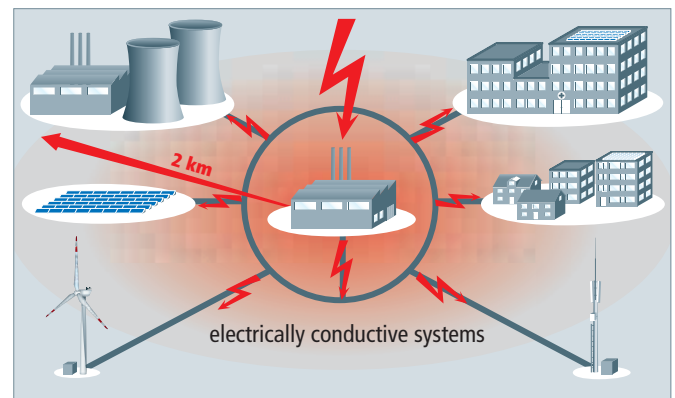

Figure 2: General risks for buildings and installations resulting from lightning strikes.

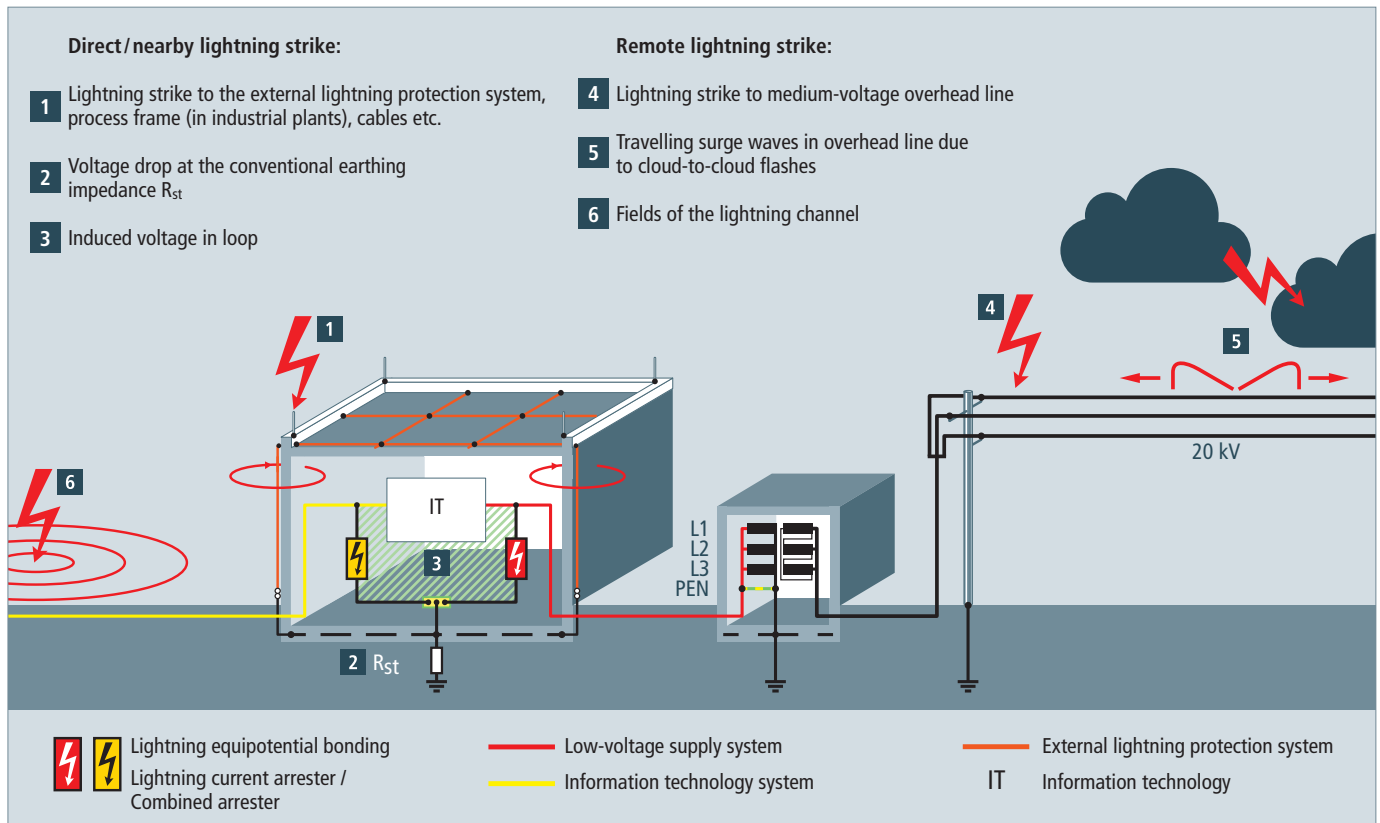

Figure 3: Causes of surges during lightning discharges.

In addition to the voltage drop at the conventional earthing impedance, surges are generated in the electric building installation and the systems and devices connected to it due to the inductive effect of the electromagnetic lightning field (Figure 3, case 3). The energy of these induced surges and of the resulting impulse currents is far lower than the energy of a direct lightning impulse current and is therefore described by a 8/20 μ s impulse current wave form (Figure 4). Components and devices that do not have to conduct currents resulting from direct lightning strikes are therefore tested with such 8/20 μ s impulse currents.

Protection scheme

Lightning strikes are called remote if they occur at a farer distance to the object to be protected, strike medium-voltage overhead lines or their surroundings or occur as cloud-to-cloud lightning discharges (Figure 3, cases 4, 5, 6). Similar to induced surges, the effects of remote lightning strikes on the electrical installation of a building are handled by devices and components which have been dimensioned according to 8/20 μ s impulse current waves. Surges caused by switching operations (SEMP) are, for example, generated by:

- Disconnection of inductive loads (e.g. transformers, reactors, motors)
- Arc ignition and interruption (e.g. arc welding equipment)
- Tripping of fuses

The effects of switching operations in the electrical installation of a building can also be simulated by impulse currents of 8/20 μ s wave form under test conditions. To ensure continuous availability of complex power supply and information technology systems even in case of direct lightning interference, further surge protection measures for electrical and electronic installations and devices based on a lightning protection system

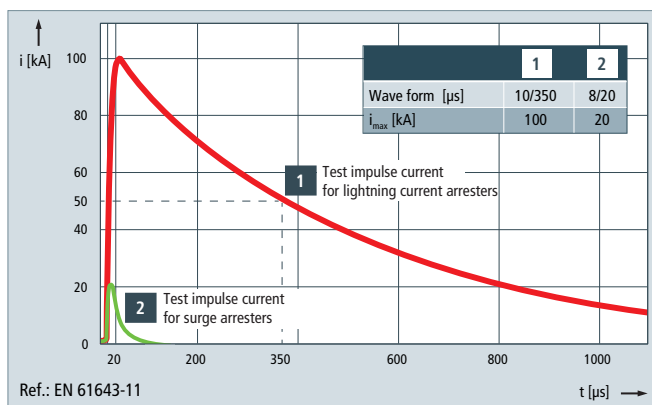

Figure 4: Test impulse currents for lightning current and surge arresters.

for the building are required. It is important to take all causes of surges into account. To do so, the lightning protection zone concept as described in IEC 62305-4 is applied (Figure 5).

Lightning protection zone concept

The building is divided into different endangered zones. These zones help to define the necessary protection measures, in particular the lightning and surge protection devices and components. Part of an EMC compatible (Electromagnetic Compatibility) lightning protection zone concept is the external lightning protection system (including air-termination system, down-conductor system, earth-termination system), equipotential bonding, spatial shielding and surge protection for the power supply and information technology systems. Definitions apply as classified in Table 1.

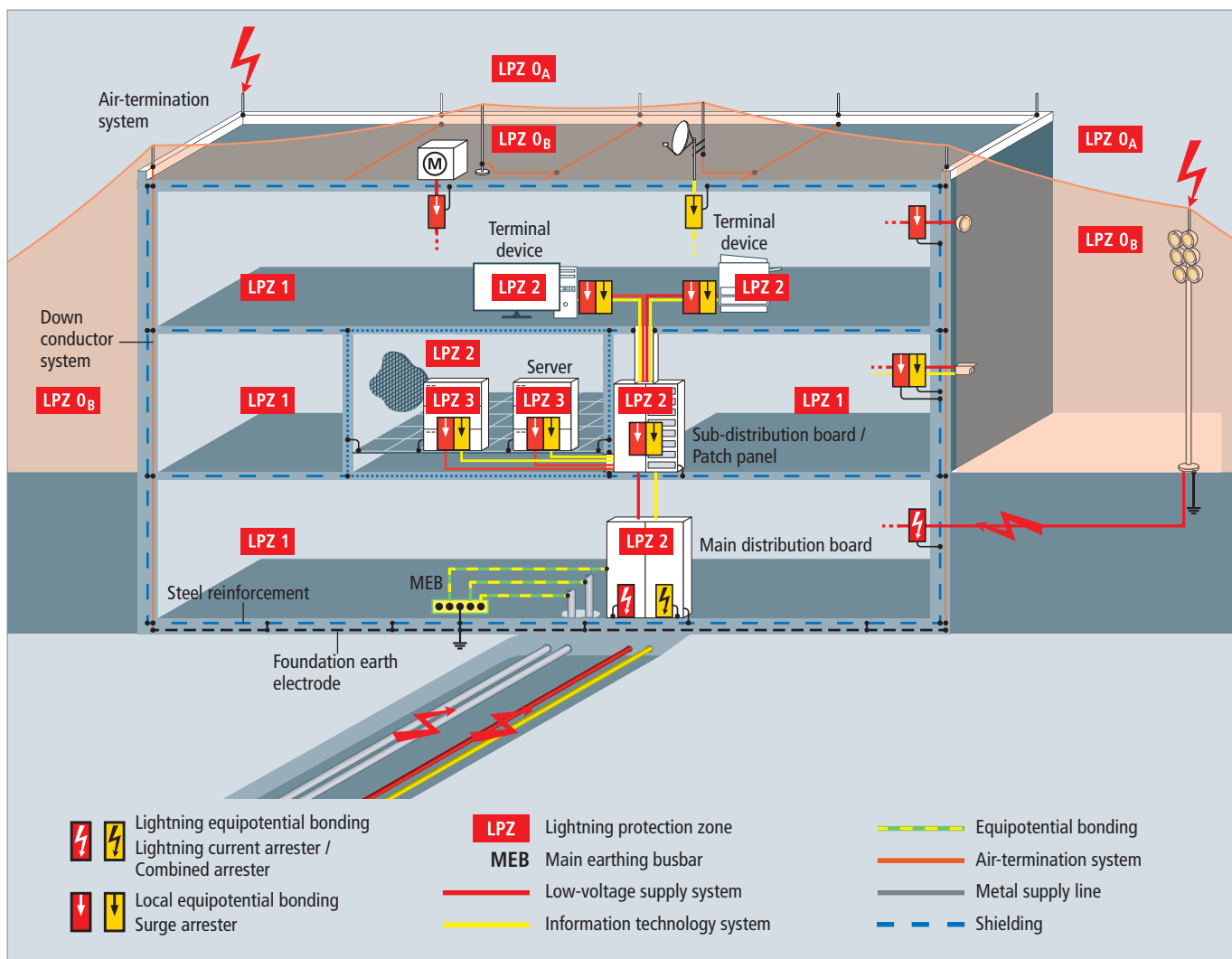
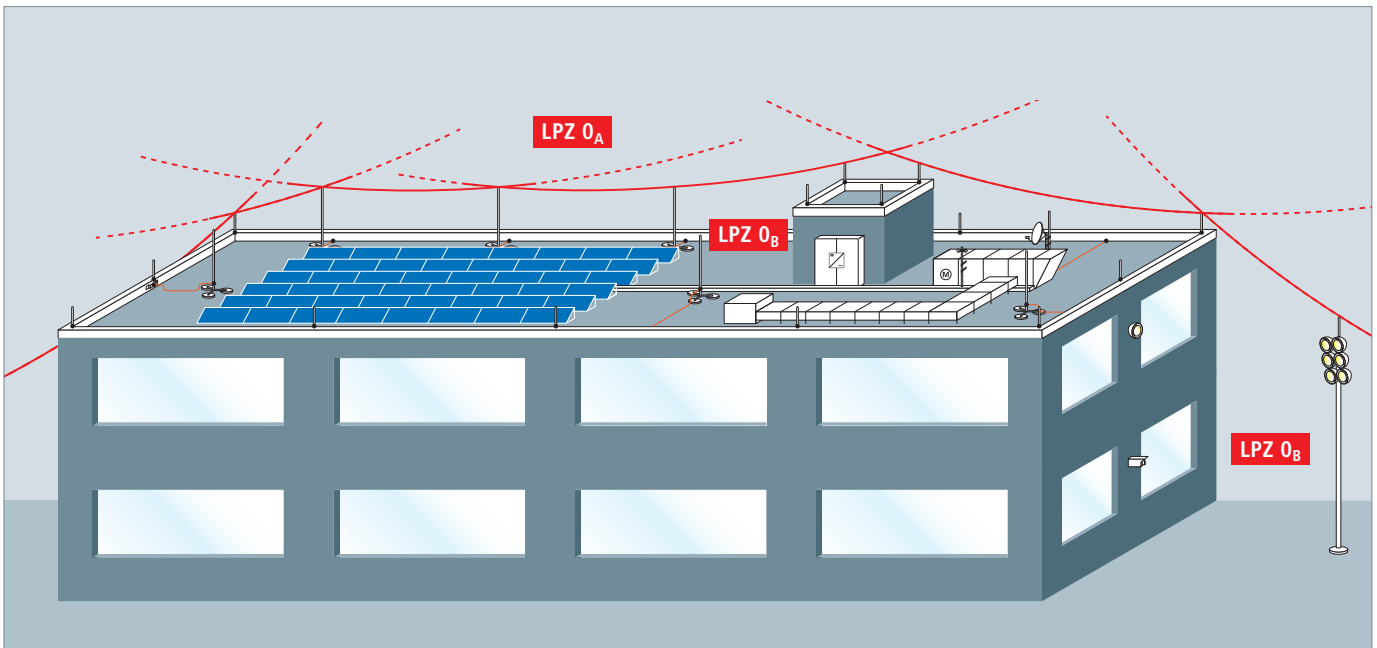
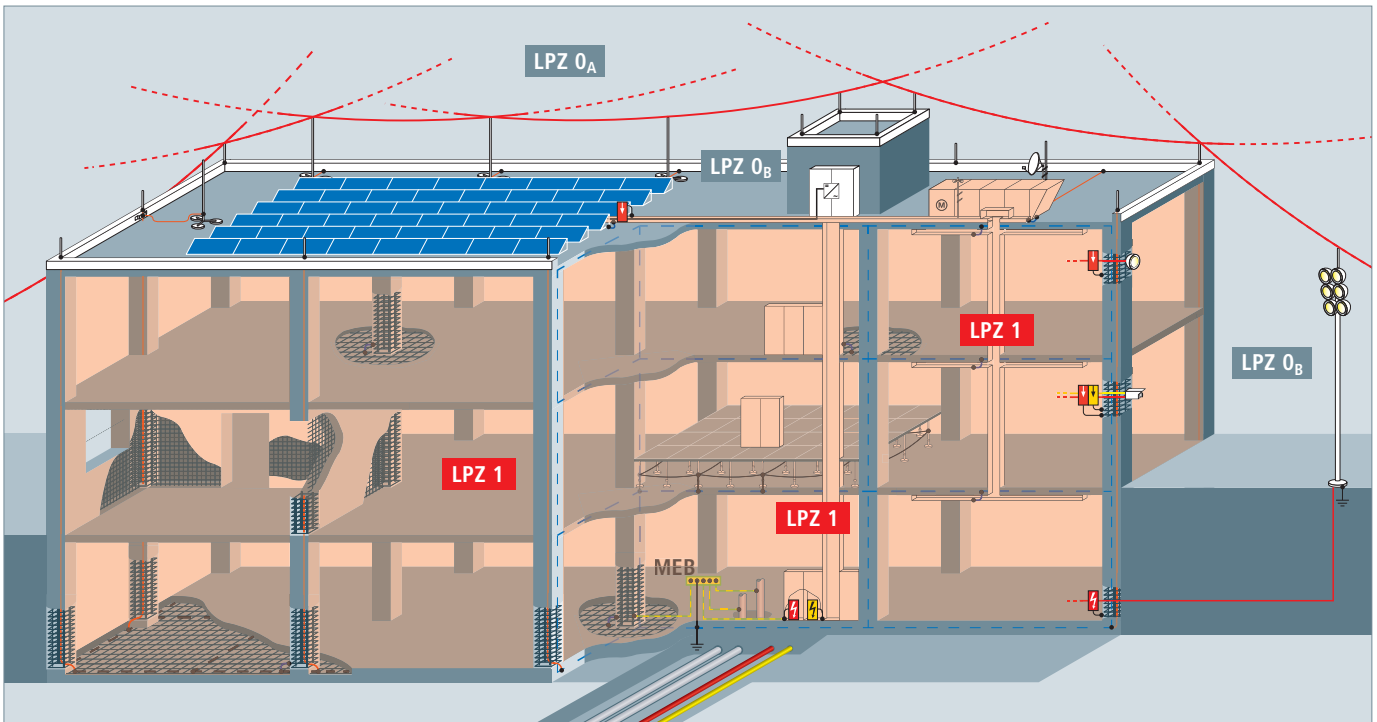

Figure 5: Overall view of a lightning protection zone concept.



▲ Figure 5.1: Transition from LPZ 0_A to LPZ 0_B (above)

▼ Figure 5.2: Transitions from LPZ 0_A to LPZ 1 and LPZ 0_B to LPZ 1 (below)



According to the requirements and loads placed on surge protective devices, they are categorised as lightning current arresters, surge arresters and combined arresters. The highest requirements are placed on the discharge capacity of lightning current arresters and combined arresters used at the transition from lightning protection zone 0_A to 1 or 0_A to 2. These arresters must be capable of conducting partial lightning currents of 10/350 μ s wave form without being destroyed in order to prevent the ingress of destructive partial lightning currents into the electrical installation of a building. At the transition point from LPZ 0_B to 1 or downstream of the lightning current arrester at the transition point from LPZ 1 to 2 and higher, surge arresters are used to protect against surges. Their task is both to reduce the residual energy of the upstream protection stages

even further and to limit the surges induced or generated in the installation itself.

The lightning and surge protective measures at the boundaries of the lightning protection zones described above equally apply to power supply and information technology systems. All measures described in the EMC compatible lightning protection zone concept help to achieve continuous availability of electrical and electronic devices and installations.

For more detailed technical information, DEHN offers a "Lightning Protection Guide" which can be downloaded at www.dehn-international.com/en/downloads.

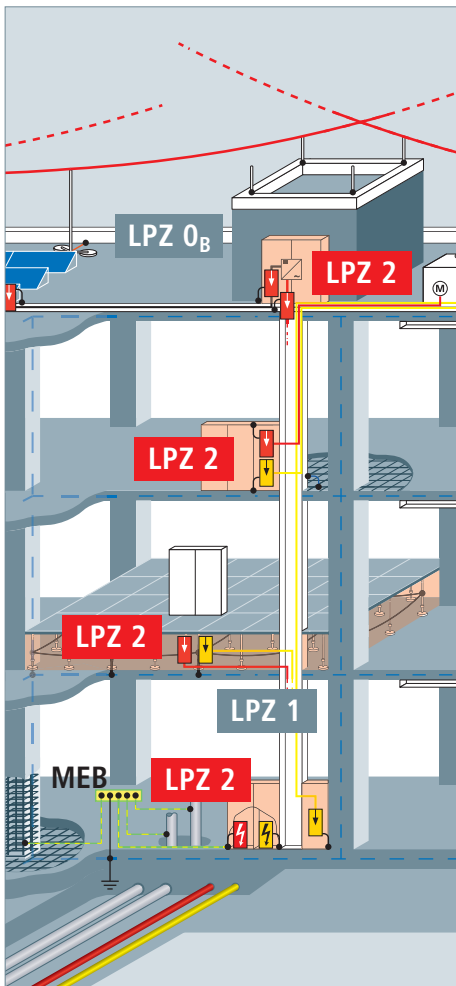

Figure 5.3: Transition from LPZ 1 to LPZ 2

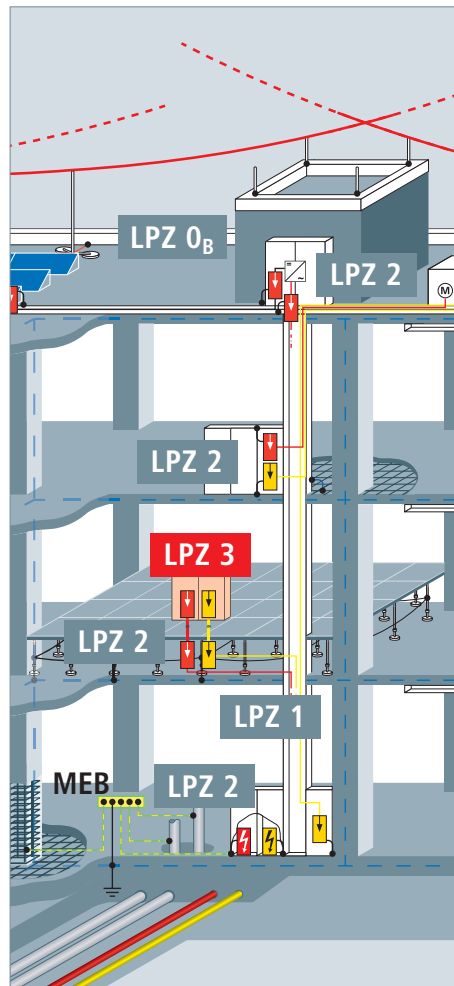
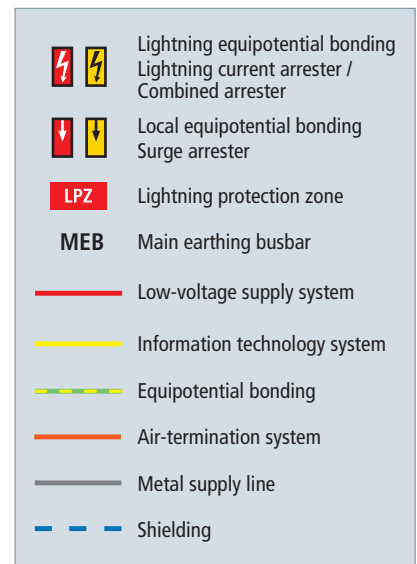

Figure 5.4: Transition from LPZ 2 to LPZ 3



IEC 62305-4:2010

Outer zones:

LPZ 0 Zone where the threat is due to the unattenuated lightning electromagnetic field and where the internal systems may be subjected to full or partial lightning surge current.

LPZ 0 is subdivided into:

LPZ 0_A Zone where the threat is due to the direct lightning flash and the full lightning electromagnetic field. The internal systems may be subjected to full lightning surge current.

LPZ 0_B Zone protected against direct lightning flashes but where the threat is the full lightning electromagnetic field. The internal systems may be subjected to partial lightning surge currents.

Inner zones (protected against direct lightning flashes):

LPZ 1 Zone where the surge current is limited by current sharing and isolating interfaces and/or by SPDs at the boundary. Spatial shielding may attenuate the lightning electromagnetic field.

LPZ 2 ... n Zone where the surge current may be further limited by current sharing and isolating interfaces and/or by additional SPDs at the boundary. Additional spatial shielding may be used to further attenuate the lightning electromagnetic field.

Table 1: Definition of lightning protection zones.

Surge Protective Devices (SPDs)

Surge protective devices are devices consisting mainly of voltage-controlled resistors (varistors, suppressor diodes) and / or spark gaps (discharge paths). Surge protective devices are used to protect other electrical equipment and installations against impermissibly high surges and / or to establish equipotential bonding.

Surge protective devices are classified:

a) according to their use into:

- **Surge protective devices for power supply systems and equipment (Red/Line® product family)**
for nominal voltage ranges up to 1000 V
– according to EN 61643-11:2012 in type 1/2/3 SPDs
– according to IEC 61643-11:2011 in class I/II/III SPDs
- **Surge protective devices for IT systems and equipment (Yellow/Line product family)**
for protecting modern electronic systems in telecommunications and signal-processing networks with nominal voltages up to 1000V a.c. [root-mean-square value (rms)] and 1500 V d.c. against the indirect and direct effects of lightning strikes and other transients.
– according to IEC 61643-21:2012, EN 61643-21:2013 and DIN VDE 0845-3-1.
- **Isolating spark gaps for earth-termination systems or equipotential bonding (Red/Line® product family)**
- **Surge protective devices for use in photovoltaic installations (Red/Line® product family)**
for nominal voltage ranges up to 1500 V
– according to EN 50539-11:2013 as type 1/2 SPDs

b) according to their impulse current discharge capacity and protective effect into:

- **Lightning current arresters / Coordinated lightning current arresters**
for interference resulting from direct or nearby lightning strikes for protecting installations and equipment [for use at the boundaries between lightning protection zones (LPZ) 0_A and 1].
- **Surge arresters**
for remote lightning strikes, switching overvoltages as well as electrostatic discharges for protecting installations, equipment and terminal devices (for use at the boundaries downstream of LPZ 0_B).
- **Combined lightning current and surge arresters**
for interference resulting from direct or nearby lightning strikes for protecting installations, equipment and terminal devices (for use at the boundaries between LPZ 0_A and 1 as well as 0_A and 2).

Technical data

The technical data of surge protective devices comprise information defining their conditions of use according to:

- use (e.g. installation, power supply conditions, temperature)
- performance in case of interference (e.g. impulse current discharge capacity, follow current extinguishing capability, voltage protection level, response time)
- performance during operation (e.g. nominal current, attenuation, insulation resistance)
- performance in case of failure (e.g. backup fuse, disconnection device, fail-safe, remote signalling option).

actiVsense®

The actiVsense technology is integrated in universal combined arresters for protecting information technology installations and devices. The arrester automatically detects the signal voltage applied and optimally adapts the voltage protection level to it. Thus, the arrester can be universally used for different interfaces and provides maximum protection for the devices and system circuits connected to it in case of failure.

Breaking capacity, follow current extinguishing capability I_{fi}

The breaking capacity is the uninfluenced (prospective) r.m.s. value of the mains follow current which can automatically be extinguished by the surge protective device when connecting U_C. It can be proven in an operating duty test according to IEC / EN 61643-11.

Categories according to IEC 61643-21:2012

A number of impulse voltages and impulse currents are described in IEC 61643-21:2012 for testing the current carrying capability and voltage limitation of impulse interference. Table 3 of this standard lists these into categories and provides preferred values. In Table 2 of the IEC 61643-22 standard the sources of transients are assigned to the different impulse categories according to the decoupling mechanism. Category C2 includes inductive coupling (surges), category D1 galvanic coupling (lightning currents). The relevant category is specified in the technical data.

DEHN + SÖHNE surge protective devices surpass the values in the specified categories. Therefore, the exact value for the impulse current carrying capability is indicated by the nominal discharge current (8/20 µs) and the lightning impulse current (10/350 µs).

Combination wave U_{0C}

A combination wave is generated by a hybrid generator (1.2/50 µs, 8/20 µs) with a fictitious impedance of 2 Ω. The open-circuit voltage of this generator is referred to as U_{0C}. U_{0C} is a preferred indicator for type 3 arresters since only these arresters may be tested with a combination wave (according to IEC / EN 61643-11).

Cut-off frequency f_G

The cut-off frequency defines the frequency-dependent behaviour of an arrester. The cut-off frequency is equivalent to the frequency which induces an insertion loss (a_E) of 3 dB under certain test conditions (see EN 61643-21:2013). Unless otherwise indicated, this value refers to a 50 Ω system.

Degree of protection

The IP degree of protection corresponds to the protection categories described in IEC / EN 60529.

Direct Current Disconnection

When using surge arresters in d.c. applications, disconnection must be reliably ensured even if there are no zero crossings. The specifically developed DC Disconnection (DCD) acts as a wedge similar to a blocking valve and interrupts the direct current. Consequently, the devices of the DEHN-guard SE DC series are capable of safely interrupting direct currents, thus preventing fire damage caused by d.c. switching arcs.

Disconnecting time t_a

The disconnecting time is the time passing until the automatic disconnection from power supply in case of a failure of the circuit or equipment to be protected. The disconnecting time is an application-specific value resulting from the intensity of the fault current and the characteristics of the protective device.

Energy coordination of SPDs

Energy coordination is the selective and coordinated interaction of cascaded protection elements (= SPDs) of an overall lightning and surge protection concept. This means that the total load of the lightning impulse current is split between the SPDs according to their energy carrying capability. If energy coordination is not possible, downstream SPDs are insufficiently relieved by the upstream SPDs since the upstream SPDs operate too late, insufficiently or not at all. Consequently, downstream SPDs as well as terminal equipment to be protected may be destroyed.

DIN CLC/TS 61643-12:2010 describes how to verify energy coordination. Spark-gap-based type 1 SPDs offer considerable advantages due to their voltage-switching characteristic (see WAVE BREAKER FUNCTION).

Frequency range

The frequency range represents the transmission range or cut-off frequency of an arrester depending on the described attenuation characteristics.

Insertion loss

With a given frequency, the insertion loss of a surge protective device is defined by the relation of the voltage value at the place of installation before and after installing the surge protective device. Unless otherwise indicated, the value refers to a 50 Ω system.

Integrated backup fuse

According to the product standard for SPDs, overcurrent protective devices / backup fuses must be used. This, however, requires additional space in the distribution board, additional cable lengths, which should be as short as possible according to IEC 60364-5-53, additional installation time (and costs) and dimensioning of the fuse. A fuse integrated in the arrester ideally suited for the impulse currents involved eliminates all these disadvantages. The space gain, lower wiring effort, integrated fuse monitoring and the increased protective effect due to shorter connecting cables are clear advantages of this concept which is integrated in the DEHNvenCI, DEHNbloc Maxi S, DEHNguard ... CI and V(A) NH product families.

LifeCheck®

Repeated discharge processes which exceed the specification of the device can overload arresters in information technology systems. In order to ensure high system availability, arresters should therefore be subjected to systematic tests. LifeCheck allows quick and easy testing of arresters (see page 133).

Lightning impulse current I_{imp}

The lightning impulse current is a standardised impulse current curve with a 10/350 μ s wave form. Its parameters (peak value, charge, specific energy) simulate the load caused by natural lightning currents. Lightning current and combined arresters must be capable of discharging such lightning impulse currents several times without being destroyed.

Mains-side overcurrent protection / arrester backup fuse

Overcurrent protective device (e.g. fuse or circuit breaker) located outside of the arrester on the infeed side to interrupt the power-frequency follow current as soon as the breaking capacity of the surge protective device is exceeded. No additional backup fuse is required since the backup fuse is already integrated in the SPD (see relevant section).

Maximum continuous operating voltage U_C

The maximum continuous operating voltage (maximum permissible operating voltage) is the r.m.s. value of the maximum voltage which may be connected to the corresponding terminals of the surge protective device during operation. This is the maximum voltage on the arrester in the defined non-conducting state, which reverts the arrester back to this state after it has tripped and discharged. The value of U_C depends on the nominal voltage of the system to be protected and the installer's specifications (IEC 60364-5-534).

Maximum continuous operating voltage U_{CPV} for a photovoltaic (PV) system

Value of the maximum d.c. voltage that may be permanently applied to the terminals of the SPD. To ensure that U_{CPV} is higher than the maximum open-circuit voltage of the PV system in case of all external influences (e.g. ambient temperature, solar radiation intensity), U_{CPV} must be higher than this maximum open-circuit voltage by a factor of 1.2 (according to CLC/TS 50539-12). This factor of 1.2 ensures that the SPDs are not incorrectly dimensioned.

Maximum discharge current I_{max}

The maximum discharge current is the maximum peak value of the 8/20 μ s impulse current which the device can safely discharge.

Maximum transmission capacity

The maximum transmission capacity defines the maximum high-frequency power which can be transmitted via a coaxial surge protective device without interfering with the protection component.

Nominal discharge current I_n

The nominal discharge current is the peak value of a 8/20 μ s impulse current for which the surge protective device is rated in a certain test programme and which the surge protective device can discharge several times.

Nominal load current (nominal current) I_L

The nominal load current is the maximum permissible operating current which may permanently flow through the corresponding terminals.

Nominal voltage U_N

The nominal voltage stands for the nominal voltage of the system to be protected. The value of the nominal voltage often serves as type designation for surge protective devices for information technology systems. It is indicated as an r.m.s. value for a.c. systems.

N-PE arrester

Surge protective devices exclusively designed for installation between the N and PE conductor.

Operating temperature range T_U

The operating temperature range indicates the range in which the devices can be used. For non-self-heating devices, it is equal to the ambient temperature range. The temperature rise for self-heating devices must not exceed the maximum value indicated.

Protective circuit

Protective circuits are multi-stage, cascaded protective devices. The individual protection stages may consist of spark gaps, varistors, semiconductor elements and gas discharge tubes (see energy coordination).

Protective conductor current I_{PE}

The protective conductor current is the current which flows through the PE connection when the surge protective device is connected to the maximum continuous operating voltage U_C , according to the installation instructions and without load-side consumers.

Remote signalling contact

A remote signalling contact allows easy remote monitoring and indication of the operating state of the device. It features a three-pole terminal in the form of a floating changeover contact. This contact can be used as break and / or make contact and can thus be easily integrated in the building control system, controller of the switchgear cabinet, etc.

Response time t_A

Response times mainly characterise the response performance of individual protection elements used in arresters. Depending on the rate of rise du/dt of the impulse voltage or di/dt of the impulse current, the response times may vary within certain limits.

Return loss

In high-frequency applications, the return loss refers to how many parts of the "leading" wave are reflected at the protective device (surge point). This is a direct measure of how well a protective device is attuned to the characteristic impedance of the system.

SCI technology

Direct currents (d.c.) flow on the generator side of a PV system. The surge protective devices used on the generator side can be overloaded due to different scenarios (e.g. impulse load, insulation faults) and must not endanger the PV system. However, insufficient d.c. disconnection capability in a PV system may cause fire. Conventional surge arresters only feature a disconnecter in the form of a simple break contact mechanism which is typically used for a.c. devices. Due to the lacking zero crossing of the d.c. source, a d.c. arc may persist and cause fire. The SCI technology patented

by DEHN + SÖHNE with active arc extinction is an ideal solution. In case of overload, a contact is opened and a short-circuit is generated (Short Circuit). Thus, a possible switching arc is actively, quickly and safely extinguished. The PV fuse integrated in the short-circuit path immediately trips after the arc has been extinguished and ensures safe electrical isolation (Interruption) (see also pages 34/87-93). Thus, all PV arresters from DEHN + SÖHNE combine surge protection, fire protection and personal protection in a single device.

Series resistance

Resistance in the direction of the signal flow between the input and output of an arrester. The series resistance is normally used to coordinate the protection stages in a multi-stage SPD.

Shield attenuation

Relation of the power fed into a coaxial cable to the power radiated by the cable through the phase conductor.

Short-circuit withstand capability

The short-circuit withstand capability is the value of the prospective power-frequency short-circuit current handled by the surge protective device when the relevant maximum backup fuse is connected upstream.

Short-circuit rating I_{SCPV} of an SPD in a photovoltaic (PV) system

Maximum uninfluenced short-circuit current which the SPD, alone or in conjunction with its disconnection devices, is able to withstand.

Temporary overvoltage (TOV)

Temporary overvoltage may be present at the surge protective device for a short period of time due to a fault in the high-voltage system. This must be clearly distinguished from a transient caused by a lightning strike or a switching operation, which last no longer than about 1 ms. The amplitude U_T and the duration of this temporary overvoltage are specified in EN 61643-11 (200 ms, 5 s or 120 min.) and are individually tested for the relevant SPDs according to the system configuration (TN, TT, etc.). The SPD can either a) reliably fail (TOV safety) or b) be TOV-resistant (TOV withstand), meaning that it is completely operational during and following temporary overvoltages.

Thermal disconnecter

Surge protective devices for use in power supply systems equipped with voltage-controlled resistors (varistors) mostly feature an integrated thermal disconnecter that disconnects the surge protective device in case of overload and indicates this operating state. The disconnecter responds to the "current heat" generated by an overloaded varistor and disconnects the surge protective device if a certain temperature is exceeded. The disconnecter is designed to disconnect the overloaded surge protective device in time to prevent a fire. It is not intended to ensure protection against indirect contact. The function of these thermal disconnecters can be tested by means of a simulated overload / ageing of the arresters.

Total discharge current I_{total}

Current which flows through the PE, PEN or earth connection of a multipole SPD during the total discharge current test. This test is used to determine the total load if current simultaneously flows through several protective paths of a multipole SPD. This parameter is decisive for the total discharge capacity which is reliably handled by the sum of the individual paths of an SPD.

Voltage protection level U_p

The voltage protection level of a surge protective device is the maximum instantaneous value of the voltage at the terminals of a surge protective device, determined from the standardised individual tests:

- Lightning impulse sparkover voltage 1,2/50 μ s (100%)
- Sparkover voltage with a rate of rise of 1 kV/ μ s
- Measured limit voltage at a nominal discharge current I_n

The voltage protection level characterises the capability of a surge protective device to limit surges to a residual level. The voltage protection level defines the installation location with regard to the overvoltage category according to IEC 60664-1 in power supply systems. For surge protective devices to be used in information technology systems, the voltage protection level must be adapted to the immunity level of the equipment to be protected (IEC 61000-4-5: 2015).

Wave breaker function



Due to the technical design of type 1 SPDs, energy coordination of SPDs considerably varies. Experience has shown that even small amplitudes of the 10/350 μ s lightning impulse current overload downstream SPDs or even destroy them if varistor-based type 1 lightning current arresters are used. In case of spark-gap-based type 1 arresters, in contrast, virtually the total current flows through the type 1 arrester. Similar to a wave breaker the energy is reduced to an acceptable level. The advantage is that the time to half value of the 10/350 μ s impulse current is reduced due to the reduction of the impulse time and the switching behaviour of type 1 SPDs. This considerably relieves downstream SPDs.





All devices of the DEHN + SÖHNE Red/Line and Yellow/Line product family are energy-coordinated. Moreover, all type 1 arresters of the Red/Line family are based on spark gaps and thus feature this WAVE BREAKER FUNCTION.















Yellow/Line SPD class

All DEHN arresters for use in information technology systems are categorised into a Yellow/Line SPD class and are marked with the corresponding symbol in the data sheet and on the rating plate (see page 132).

Definition of Symbols

Symbol	Definition
	Installation instructions, see www.dehn-international.com
	New products
	Discontinued products

Symbol	Definition	Red/Line®
	Integrated backup fuse Reduced space requirements, lower installation costs, faster wiring and shorter connecting cable lengths are clear advantages of this concept used for the DEHNvenCI, DEHNbloc Maxi S, DEHNguard ... CI and V(A) NH product series.	
	SCI technology The patented SCI technology with active arc extinction allows to actively, quickly and safely extinguish a possible switching arc in case of overload. The PV fuse integrated in the short-circuit path trips immediately after the arc has been extinguished, thus ensuring safe electrical isolation (Interruption). Consequently, all PV arresters from DEHN combine surge protection, fire protection and personal protection in a single device.	
	Wave breaker function If a spark-gap-based type 1 arrester is used, the total current flows through the type 1 arrester during the discharge process. Similar to a wave breaker, the energy is mitigated to a sufficiently low level, thus considerably relieving downstream SPDs. The WAVE BREAKER function is integrated in all sparkgap-based type 1 arresters of the Red/Line series.	
	Direct Current Disconnection When using surge arresters in d.c. applications, disconnection must be reliably ensured even if there are no zero crossings. The specifically developed DC Disconnection (DCD) acts as a wedge similar to a blocking valve and interrupts the direct current. Consequently, the devices of the DEHNguard SE DC series are capable of safely interrupting direct currents, thus preventing fire damage caused by d.c. switching arcs.	

Symbol	Definition	Yellow/Line
	Compact 3-in-1 protection This arrester allows 3 interfaces to be protected by means of a single device, resulting in reduced space requirements, faster wiring and lower installation costs.	
	LifeCheck® LifeCheck allows to easily and quickly test arresters for information technology systems. It permanently monitors the condition of the arrester and detects electrical and thermal load on all protection components.	
	actiVsense® Arrester technology for arresters for information technology systems. actiVsense automatically detects the signal voltage applied and optimally adapts the voltage protection level to it. Thus, the arrester can be universally used for different interfaces and always provides maximum protection for the connected devices and system circuits in case of failure.	
	Discharge capacity of an SPD (according to the categories from IEC 61643-21) Impulse D1 (10/350), lightning impulse current ≥ 2.5 kA / line or ≥ 5 kA / total • exceeds the discharge capacity of TYPE 2 – TYPE 4	
	Impulse C2 (8/20), increased impulse load ≥ 2.5 kA / line or ≥ 5 kA / total • exceeds the discharge capacity of TYPE 3 – TYPE 4	
	Impulse C1 (8/20), impulse load ≥ 0.25 kA / line or ≥ 0.5 kA / total • exceeds the discharge capacity of TYPE 4	
	Load < TYPE 3	
	Protective effect of an SPD (limitation below the test levels according to EN 61000-4-5) Required test level of the terminal device: 1 or higher	
	Required test level of the terminal device: 2 or higher	
	Required test level of the terminal device: 3 or higher	
	Required test level of the terminal device: 4	
	Energy coordination (with another Yellow/Line SPD) SPD with decoupling impedance, suitable for coordination with an SPD marked with 	
	SPD is suitable for coordination with an SPD with decoupling impedance 	

DEHNselect SPD Tool – Planning of internal Lightning Protection and Surge Protection

Practice-oriented – Professional – User-friendly

Find the right product quickly and easily with the help of our surge protection assistants for power supply and information technology systems.



The new DEHNselect SPD software module allows to define and select all necessary internal lightning protection and surge protection products. It creates a structure plan with a bill of materials and allows fast online access to all documents for the products selected such as data sheets and installation instructions.

DEHNselect SPD can be easily used without special knowledge or training. The user-friendly surface facilitates operating the program.

This electronic planning and selection aid provides easy and practice-oriented support for e.g. designers, electricians and installers of lightning protection systems, thus making it considerably easier to professionally implement a surge protection concept.

For more detailed information, see brochure DS 709 E (DEHNsupport Toolbox) or visit www.dehn-international.com/en/selection-guides-and-configurators.

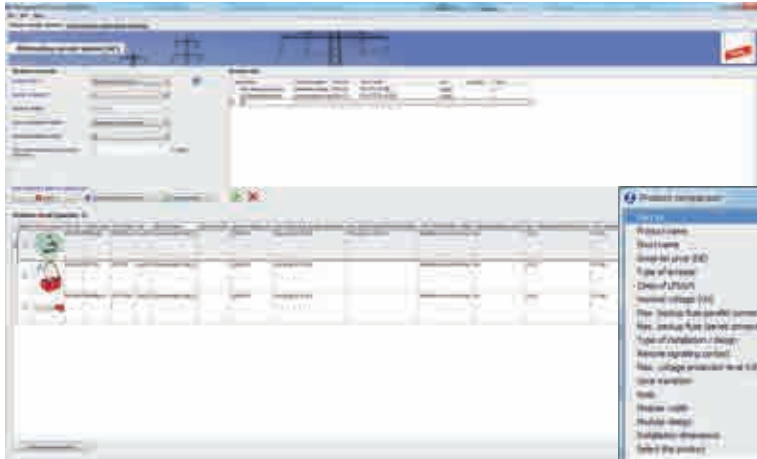

Filter function allows easy product selection

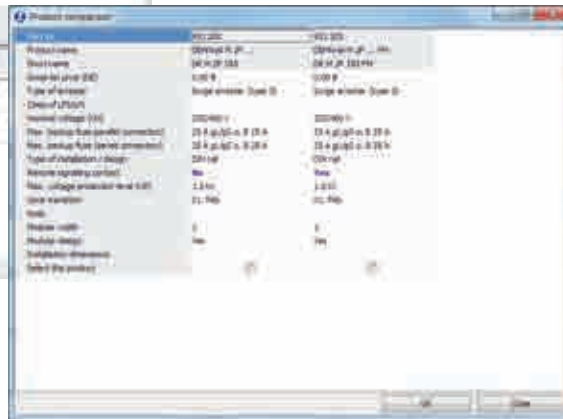

Product comparison

Bill of material

Description	Part No.	Short name	Unit	Qty
Main distribution board	181 200 0000 V 230 FM		1 pc	1
Sub-distribution board	181 200 0000 V 230 FM		1 pc	1
Sub-distribution board	181 200 0000 V 230 FM		1 pc	1
Sub-distribution board	181 200 0000 V 230 FM		1 pc	1
Sub-distribution board	181 200 0000 V 230 FM		1 pc	1
Sub-distribution board	181 200 0000 V 230 FM		1 pc	1
Sub-distribution board	181 200 0000 V 230 FM		1 pc	1
Sub-distribution board	181 200 0000 V 230 FM		1 pc	1
Sub-distribution board	181 200 0000 V 230 FM		1 pc	1
Sub-distribution board	181 200 0000 V 230 FM		1 pc	1

Bill of materials



Structure plan

Product Data Sheet: DEHNventil® modular

DV M TNS 255 FM (951 405)

- Preselected spark-gap based type 1 and type 2 combined lightning current and surge arrester consisting of a base part and plug-in protection modules
- Maximum system availability due to RACAX Flow follow current limitation
- Capable of protecting terminal equipment

Modular combined lightning current and surge arrester for TN-S systems

Type	Max. continuous operating voltage (Uc)	Max. continuous operating voltage (Uc) (L)	Max. continuous operating voltage (Uc) (N)
1	180 V	180 V	180 V
2	180 V	180 V	180 V

DEHN + SÖHNLE GmbH • Co. KG • Harna-Dehn-Str. 1 • Postfach 1640 • D-52206 Neunkirchen • Tel: +49 5191 905-0

Product data sheet

Product Data Sheet: BLITZDUCTOR® XT – Protection Modules with LifeCheck®

BXT ML4 B 180 (920 310)

- LifeCheck SPD monitoring function
- Four-point lightning protection bonding
- For evaluation in conformity with the lightning protection zone concept at the boundaries from L₁-1 and higher

Space-saving four-pole lightning current arrester module with LifeCheck feature for almost all types of applications. For use in connection with four-point lightning protection bonding.

Parameter	Value
Max. continuous operating voltage (Uc) (L)	180 V
Max. continuous operating voltage (Uc) (N)	180 V
Max. continuous operating voltage (Uc) (L)	180 V
Max. continuous operating voltage (Uc) (N)	180 V
Max. continuous operating voltage (Uc) (L)	180 V
Max. continuous operating voltage (Uc) (N)	180 V
Max. continuous operating voltage (Uc) (L)	180 V
Max. continuous operating voltage (Uc) (N)	180 V

DEHN + SÖHNLE GmbH • Co. KG • Harna-Dehn-Str. 1 • Postfach 1640 • D-52206 Neunkirchen • Tel: +49 5191 905-0

Product data sheet

Surges – an underestimated risk

Surges are an often underestimated risk. These voltage pulses (transients) that only take a split second are caused by direct, nearby and remote lightning strikes or switching operations of a power utility.

Direct and nearby lightning strikes

Direct or nearby lightning strikes are lightning strikes into a building, in its close proximity or in lines entering the building (e.g. low-voltage power supply system, telecommunication and data lines). The amplitude and energy content of the resulting impulse currents and impulse voltages as well as the associated electromagnetic field (LEMP) considerably threaten the system to be protected.

The lightning current resulting from a direct lightning strike into a building causes a rise in potential of several 100,000 volts on all earthed devices. Surges are caused by the voltage drop at the conventional earthing impedance and the resulting potential rise of the building with respect to the environment. This is the highest stress on electrical systems in buildings.

In addition to the voltage drop at the conventional earthing impedance, surges occur in the electrical installation of the building and in the connected systems and devices due to the induction effect of the lightning electromagnetic field. The energy of these induced surges and the resulting impulse currents are lower than that of the direct lightning impulse current.

Remote lightning strikes

Remote lightning strikes are lightning strikes far away from the object to be protected, in the medium-voltage overhead line network or in its close proximity as well as cloud-to-cloud discharge.

Switching operations

Switching operations of power utilities cause surges (SEMP – Switching Electromagnetic Pulse) of some 1,000 volts in electrical systems. They occur, for example, when inductive loads (e.g. transformers, reactors, motors) are switched off, arcs are ignited or fuses trip. If power supply and data lines are installed in parallel, sensitive systems may be interfered with or destroyed.

Protection of power supply and data systems

Destructive transients in residential, office and administration buildings and industrial plants are likely to occur in, for example, the power supply system, information technology system and telephone system, control systems of production facilities via the fieldbus and controllers of air-conditioning or lighting systems. These sensitive systems can only be protected by a comprehensive protection concept. In this context, the coordinated use of surge protective devices (lightning current and surge arresters) is paramount.

The function of lightning current arresters is to discharge high energies without destruction. They are installed as close as possible to the point where the electrical system enters the building. Surge arresters, in turn, protect terminal equipment. They are installed as close as possible to the equipment to be protected.

With its Red/Line for power supply systems and its Yellow/Line for data systems, DEHN offers harmonised surge protective devices. The modular portfolio allows cost-optimised implementation of protection concepts for all building types and installation sizes.



Solutions for Industrial Plants

Automation systems are standard in most industrial companies. If the automation system fails, production comes to a halt. This can bring a company to the verge of ruin.



Office and Administration Buildings

Office and administration buildings are at least equipped with PCs, servers, networks and telecommunication systems. Failure of these systems would bring operation to a standstill since all work processes depend on these systems. Moreover, building automation systems linked via bus systems such as KNX and LON are used in these buildings.



Residential Buildings

Our modern residential buildings are equipped with a variety of high-quality technical devices – with rising tendency. These devices are vulnerable to damage caused by overvoltage and may even fail completely. In this case the damage loss can easily amount to some thousand Euros.

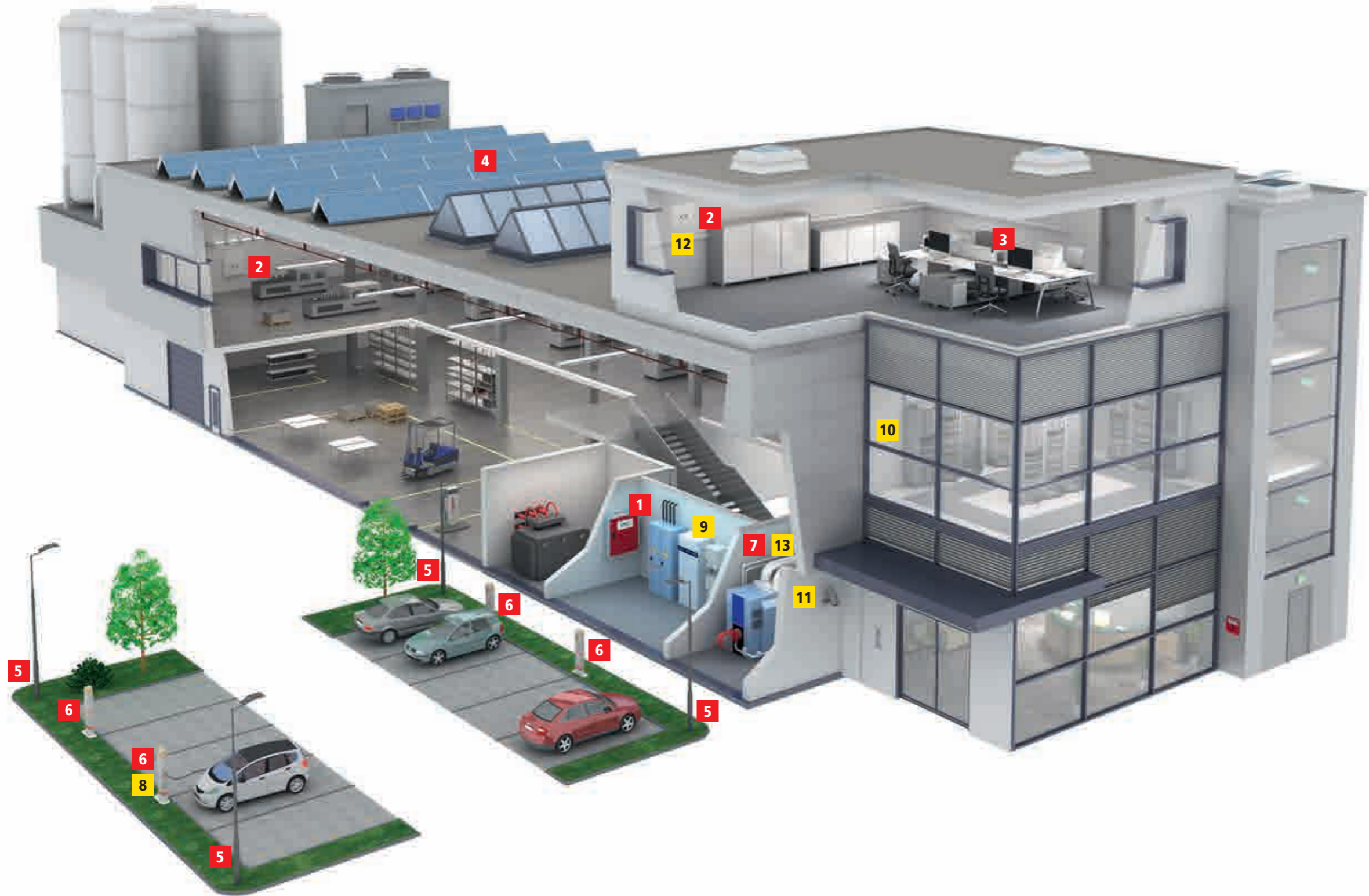

On the following pages you will find detailed selection tables for arresters for industrial buildings:

Surge Protection for Power Supply Systems	
	Page
Combined Arresters / Lightning Current Arresters – Type 1 / Type 2	20
Surge Arresters – Type 2	54
Surge Arresters – Type 3	103
Surge Protection for Information Technology Systems	
	Page
Easy Choice according to Interface/Signal	135

Position	Application (example)	Type	Part No.	Page
1	Entrance point into the building / main low-voltage distribution board	DEHNvenCI 255 FM	961 205	27
2	Sub-distribution	DEHNguard® M TNS CI 275 FM	952 406	57
3	Terminal equipment	DEHNsafe 230 LA	924 370	111
4	PV system	DEHNcombo YPV SCI 1000	900 061	34
5	Outdoor lighting	DEHNcord L 3P 275 SO IP	900 447	82
6	E-mobility	DEHNshield TT FM	941 315	30
7	Heating control / Air-conditioning control	DEHNrail M 4P 255 FM	953 405	106

Position	Application (example)	Type	Part No.	Page
8	E-mobility	BLITZDUCTOR XT® Base Part BXT BAS Module BXT ML4 BD HF 24	920 300 920 375	158 161
9	Telecommunications	Routing Module TL2 10DA CC Plug-in SPD block DRL 10 B 180 FSD Earthing frame EF 10 DRL Protective plug DRL PD 180	907 991 907 401 907 498 907 430	195 189 191 190
10	Data line	DEHNpatch Class E	929 121	204
11	Security systems / Camera	DEHNpatch CLE IP66 or DEHNvario BNC RS485 230	929 221 928 440	203 182
12	KNX bus	BUSTector BT 24	925 001	212
13	Heating	DEHNconnect SD2 ME 24	917 921	178

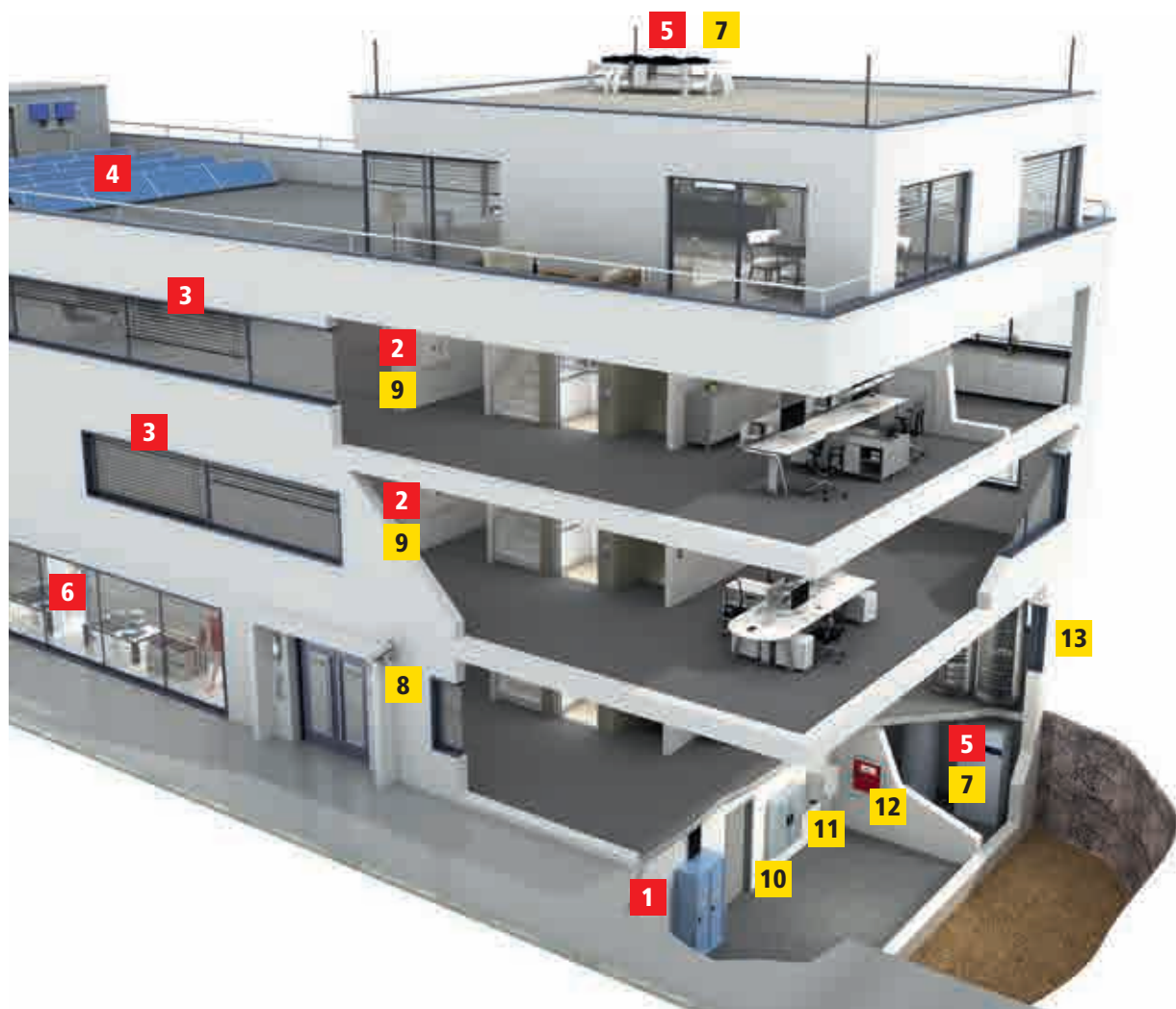

Position	Application (example)	Type	Part No.	Page
1	Entrance point into the building / main low-voltage distribution board	DEHNventil® M TNS 255 FM	951 405	23
2	Floor distributor	DEHNguard® M TNS CI 275 FM	952 406	57
3	Shutter control	DEHNcord R 3P 275	900 449	82
4	PV system	DEHNguard® M YPV 1200 FM	952 565	86
5	Heating control / Air-conditioning control	DEHNguard® M TNS 275 FM	952 405	62
6	Protection of terminal equipment	DEHNflex M	924 396	115
7	Heating control / Air-conditioning control	BLITZDUCTOR SP®Base Part BXT BAS Module BSP M2 BE 24	920 300 926 224	158 168
8	Security systems	DEHNpatch CLE IP66 or DEHNvario BNC RS485 230	929 221 928 440	203 182
9	KNX bus	BUSsector BT 24	925 001	212
10	Telecommunications	Routing Module TL2 10DA CC Plug-in SPD block DRL 10 B 180 FSD Earthing frame EF 10 DRL Protective plug DRL PD 180	907 991 907 401 907 498 907 430	195 189 191 190
11	Electroacoustic systems	DEHNvario 2 BY S 150 FM	928 430	182
12	Fire alarm system	BLITZDUCTOR XT®Base Part BXT BAS Module BXT ML4 BE 24	920 300 920 324	158 160
13	Data technology	DEHNpatch Class E	929 121	204

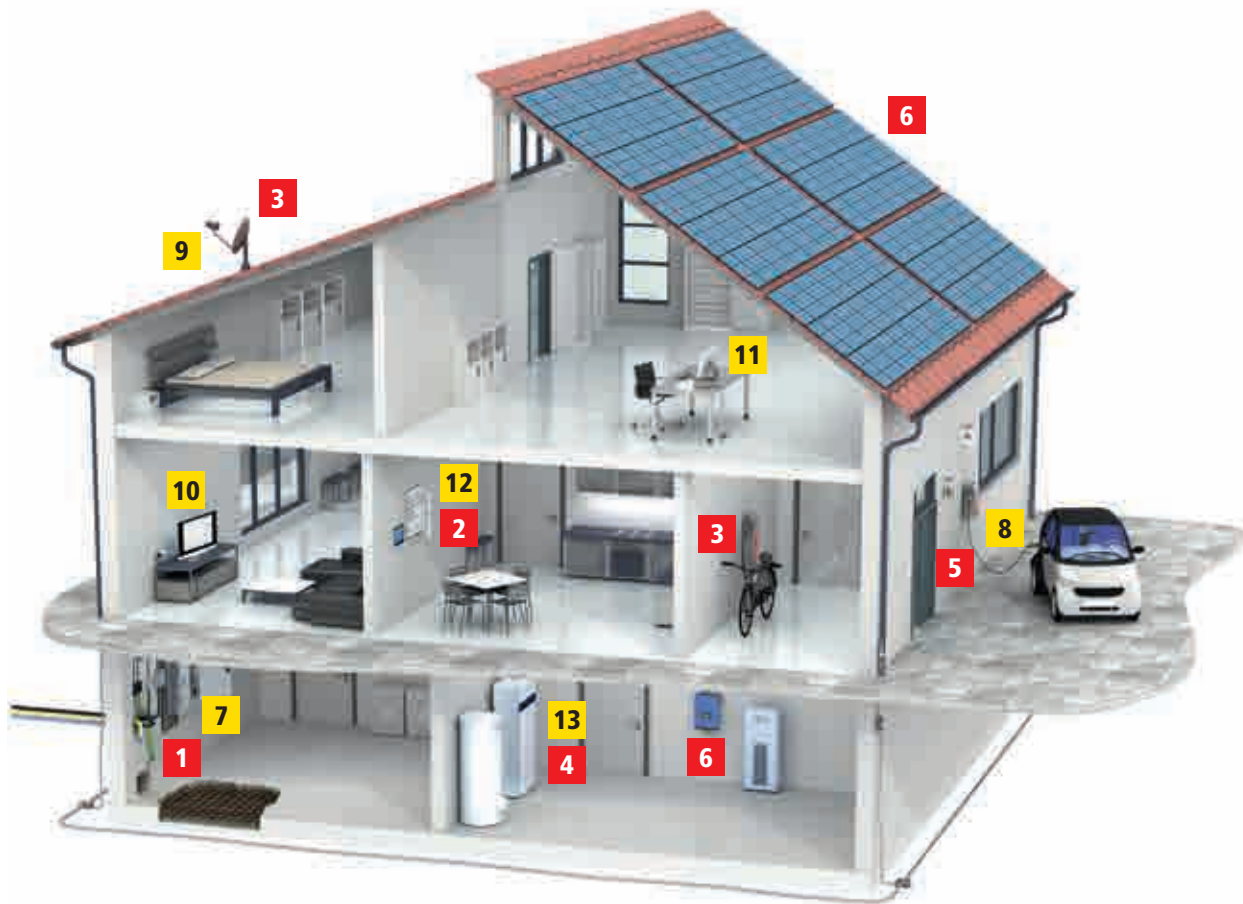

Position	Application (example)	Type	Part No.	Page
1	Entrance point into the building	DEHNshield® TT 255 FM	941 315	30
2	Sub-distribution	DEHNguard® M TNS 275	952 400	62
3	Protection of terminal equipment	DEHNflex M 255	924 396	115
4	Heating control	DEHNrail M 2P 255	953 200	104
5	E-mobility	DEHNguard TNS 275 FM	952 405	62
6	PV system	DEHncube YPV SCI 1000 1M	900 910	93
7	Entrance point into the building	DEHNbox TC 180	922 210	214
8	E-mobility	BLITZDUCTOR® XT Base Part BXT BAS Module BXT ML4 BD HF 24	920 300 920 375	158 161
9	Satellite system	DEHNgate FF5 TV	909 706	220
10	TV connection	DEHNprotector 230 TV	909 300	210
11	Computer workstation	DEHNprotector 230 LAN100	909 321	211
12	KNX bus	BUSector BT 24	925 001	212
13	Heating control	BLITZDUCTOR SP® Base Part BXT BAS Module BSP M2 BE 24	920 300 926 224	158 168

On the following pages you will find detailed selection tables for arresters for office and administration buildings and residential buildings:

Surge Protection for Power Supply Systems	Page
Combined Arresters / Lightning Current Arresters – Type 1 / Type 2	20
Surge Arresters – Type 2	54
Surge Arresters – Type 3	103
Surge Protection for Information Technology Systems	Page
Easy Choice according to Interface/Signal	135

Surge Protection for POWER SUPPLY SYSTEMS

SPDs for low-voltage Installations and Devices



Red / Line®

International Power Supply Systems

International system configurations* according to IEC 60364-1

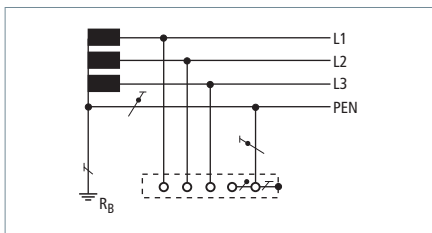

TN-C system 230 / 400 V

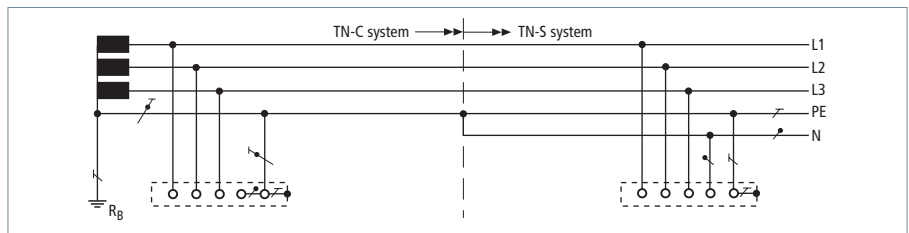

TN-C-S system 230 / 400 V

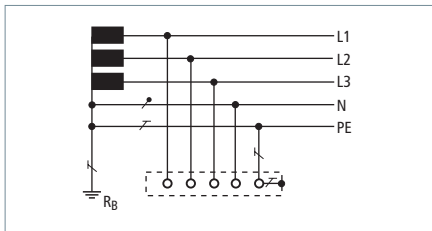

TN-S system 230 / 400 V

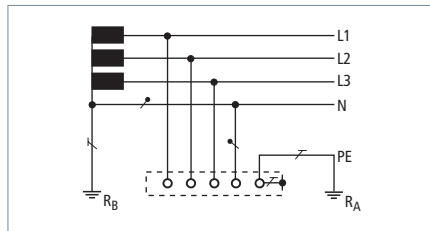

TT system 230 / 400 V

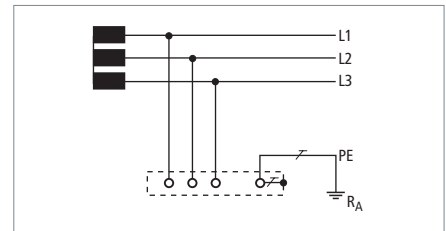

IT system 230 V

Further international system configurations*

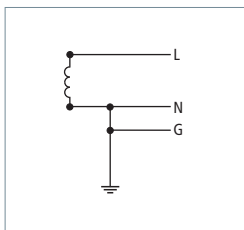

single-phase; 3 wire

(1 Ph, 2 W + G)
110 V
120 V
220 V
240 V

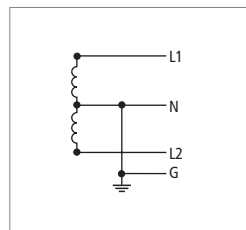

single-phase; 4 wire
Split Phase or Edison

(1 Ph, 3 W + G)
120 V / 240 V

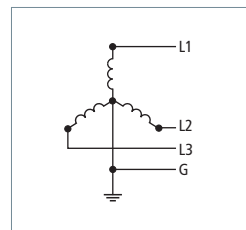

three-phase; 4 wire

(3 Ph Y, 3 W + G)
480 V

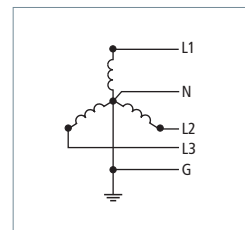

three-phase; 5 wire

(3 Ph Y, 4 W + G)
120 V / 208 V
277 V / 480 V

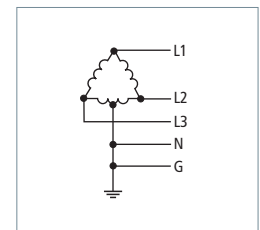

three-phase; 5 wire
Delta "Highleg"

(3 Ph Δ, 4 W + G)
120 V / 240 V

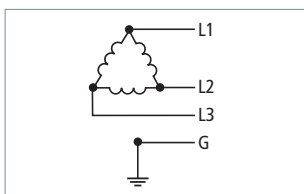

three-phase; 4 wire
Delta "Ungrounded"

(3 Ph Δ, 3 W + G)
240 V
480 V

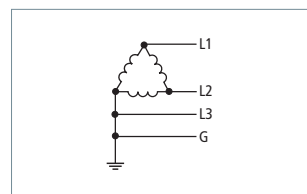

three-phase; 4 wire
Delta "Grounded Corner"

(3 Ph Δ, 3 W + G)
240 V
480 V

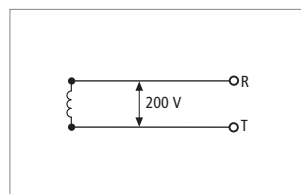

single-phase; 2 wire

(1 Ph, 2 W)
200 V

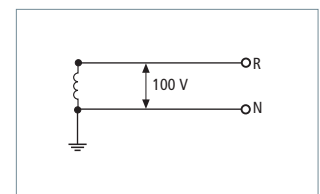

single-phase; 2 wire

(1 Ph, 2 W)
100 V

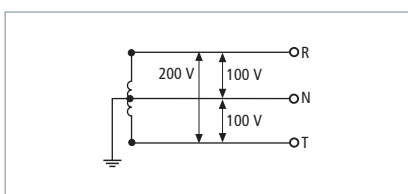

single-phase; 3 wire

(1 Ph, 3 W)
100 V / 200 V

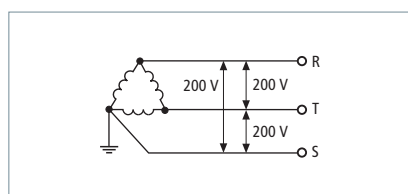

three-phase; 3 wire

(3 Ph, 3 W)
200 V

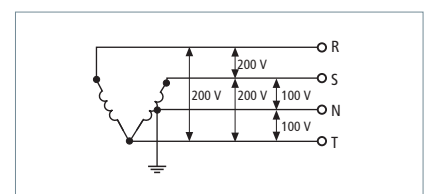

three-phase + single-phase

100 V / 200 V; 200 V

* System according to the earth connection (according to IEC 60364-1)



General

18



Combined Arresters – Type 1 + Type 2

20



Lightning Current Arresters – Type 1

35



N-PE Lightning Current Arresters

51



Surge Arresters – Type 2

54



Surge Arresters – Type 3

103



General Accessories

119

Selection Chart – Industrial Buildings

TN-C system	TN-S system	TT system	230/400 V a.c.	400/690 V a.c.	Higher voltages (a.c.)	Integrated backup fuse	Type 1 + type 2 combined backup	Type 1 + type 2 (+ type 3)* combined arresters	Type 1 lightning current arresters	DIN rail	Busbar	d.c. applications	PV system	Remote signalling contact (FM)	Type	Part No.	Page
3 pcs	4 pcs	3 pcs	●			●	●		●						DVCI 1 255	961 200	27
		N-PE	●				●		●						DGPM 1 255	961 180	52
3 pcs	4 pcs	3 pcs	●			●	●		●				●		DVCI 1 255 FM	961 205	27
		N-PE	●				●		●				●		DGPM 1 255 FM	961 185	52
1 pc			●				●		●						DV M TNC 255	951 300	23
1 pc			●				●		●				●		DV M TNC 255 FM	951 305	23
	1 pc		●				●		●						DV M TNS 255	951 400	23
	1 pc		●				●		●				●		DV M TNS 255 FM	951 405	23
		1 pc	●				●		●						DV M TT 255	951 310	23
		1 pc	●				●		●				●		DV M TT 255 FM	951 315	23
3 pcs	4 pcs	3 pcs	●					●	●						DB M 1 255	961 120	36
		N-PE	●					●	●						DGP M 255	961 101	52
3 pcs	4 pcs	3 pcs	●					●	●				●		DB M 1 255 FM	961 125	37
		N-PE	●					●	●				●		DGP M 255 FM	961 105	52
3 pcs	4 pcs	3 pcs	●			●		●		●			910 631		DBM 1 255 S	900 220	44
		N-PE	●					●		●			910 631		DGPM 1 255 S	900 050	52
3 pcs	4 pcs	3 pcs		●		●		●	●				●		DBM 1 CI 440 FM	961 146	41
3 pcs	4 pcs	3 pcs		●				●	●				●		DBM 1 440 FM	961 145	43
		N-PE		●				●	●				●		DGPM 440 FM	961 165	52
3 pcs	4 pcs	3 pcs		●				●	●						DBM 1 440	961 140	43
		N-PE		●				●	●						DGPM 440	961 160	52
3 pcs	4 pcs			●		●		●	●				●		DBM 1 CI 760 FM	961 176	41
3 pcs	4 pcs			●				●	●				●		DBM 1 760 FM	961 175	43
								●	●			●			DSE M 1 242	971 122	48
								●	●			●		●	DSE M 1 242 FM	971 127	47
							●		●			●	●		DCB YPV SCI 1000	900 061	33
							●		●			●	●		DCB YPV SCI 1000 FM	900 066	33

* Energy coordination with terminal equipment (≤ 10 m)

Selection Chart – Office and Administration Buildings

TIN-C system	TIN-S system	TT system	Integrated backup fuse	Type 1 + type 2 (+ type 3)* combined arresters	Type 1 lightning current arresters	DIN rail	Busbar	d.c. applications	Remote signalling contact (FM)	Type	Part No.	Page
3 pcs	4 pcs	3 pcs	•	•		•				DVCI 1 255	961 200	27
		1 pc		•		•				DGPM 1 255	961 180	52
3 pcs	4 pcs	3 pcs	•	•		•			•	DVCI 1 255 FM	961 205	27
		1 pc		•		•			•	DGPM 1 255 FM	961 185	52
1 pc				•		•				DV M TNC 255	951 300	23
1 pc				•		•			•	DV M TNC 255 FM	951 305	23
	1 pc			•		•				DV M TNS 255	951 400	23
	1 pc			•		•			•	DV M TNS 255 FM	951 405	23
		1 pc		•		•				DV M TT 255	951 310	23
		1 pc		•		•			•	DV M TT 255 FM	951 315	23
3 pcs	4 pcs	3 pcs			•	•				DB M 1 255	961 120	36
		1 pc			•	•				DGP M 255	961 101	52
3 pcs	4 pcs	3 pcs			•	•			•	DB M 1 255 FM	961 125	37
		1 pc			•	•			•	DGP M 255 FM	961 105	52
3 pcs	4 pcs	3 pcs	•		•		•		910 631	DBM 1 255 S	900 220	44
		1 pc	•		•		•		910 631	DGPM 1 255 S	900 050	52
				•		•		•		DSE M 1 242	971 122	46
				•		•		•	•	DSE M 1 242 FM	971 127	47

Combined Arresters – Type 1 + Type 2

Selection Chart – Residential Buildings

TIN-C system	TIN-S system	TT system	Type 1 + type 2 (+ type 3)* combined arresters	Type 1 lightning current arresters	DIN rail	External LPS installed	Busbar 40 mm	PV system	Remote signalling contact (FM)	Type	Part No.	Page
1 pc			•		•	•				DSH TNC 255	941 300	29
1 pc			•		•	•			•	DSH TNC 255 FM	941 305	29
1 pc			•		•				•	DSH B TNC 255 FM	941 306	29
	1 pc		•		•	•				DSH TNS 255	941 400	29
	1 pc		•		•	•			•	DSH TNS 255 FM	941 405	30
	1 pc		•		•				•	DSH B TNS 255 FM	941 406	30
		1 pc	•		•	•				DSH TT 255	941 310	30
		1 pc	•		•	•			•	DSH TT 255 FM	941 315	30
		1 pc	•		•				•	DSH B TT 255 FM	941 316	31
3 pcs	4 pcs	3 pcs		•	•	•				DB M 1 255	961 120	36
		N-PE		•	•	•				DGP M 255	961 101	52
3 pcs	4 pcs	3 pcs		•	•	•			•	DB M 1 255 FM	961 125	37
		N-PE		•	•	•			•	DGP M 255 FM	961 105	52
			•		•	•		•		DCB YPV SCI 1000	900 061	33
			•		•	•		•	•	DCB YPV SCI 1000 FM	900 066	33

* Energy coordination with terminal equipment (≤ 10 m)

DEHNventil® modular



For protecting low-voltage consumer's installations against surges and even direct lightning strikes. For installation in conformity with the lightning protection zone concept at the boundaries from 0_A – 2.

- Prewired spark-gap-based type 1 and type 2 combined lightning current and surge arrester consisting of a base part and plug-in protection modules
- Maximum system availability due to RADAX Flow follow current limitation
- No tripping of 20 A gG fuses up to short-circuit currents of 50 kA_{rms}
- Discharge capacity up to 100 kA (10/350 μs)
- Capable of protecting terminal equipment
- Operating state/fault indication by green/red indicator flag in the inspection window
- Easy replacement of protection modules without tools due to module locking system with module release button
- Vibration and shock-tested according to EN 60068-2

- DEHNventil M TNC 255: Modular combined lightning current and surge arrester for use in TN-C systems
- DEHNventil M TNS 255: Modular combined lightning current and surge arrester for use in TN-S systems
- DEHNventil M TT 255: Modular combined lightning current and surge arrester for use in TT and TN-S systems (3+1 configuration)
- DEHNventil M TN 255: Modular combined lightning current and surge arrester for use in single-phase TN systems
- DEHNventil M TT 2P 255: Modular combined lightning current and surge arrester for use in single-phase TT and TN systems (1+1 configuration)
- DEHNventil M ... FM: With remote signalling contact for monitoring device (floating changeover contact)

With their functional Red/Line design, the devices of the modular DEHNventil family provide a combination of safety and innovation. Designed for "all-in-one installation", the arresters integrate lightning equipotential bonding and surge protection in a single device, making them ideal for use in compact electrical installations. The energy-coordinated arresters even allow to protect terminal equipment if the distance between DEHNventil and the loads is ≤ 10 m. With a lightning current discharge capacity up to 100,000 A, the arresters ensure a high degree of availability of the electrical installation to be protected. Even in large-scale electrical installations, the modular DEHNventil arresters provide various application benefits. The Red/Line surge arresters installed at the boundaries of the individual lightning protection zones, for example, are already energy-coordinated with the DEHNventil arresters. Encapsulated creepage discharge spark gaps and the small space requirements enable easy integration into switchgear installations or distribution boards. A special feature of the modular DEHNventil family is its functional design, in particular the module locking system. It fixes the protection module firmly in place so that it is safely connected to the base part even with maximum loads. If a protection module has to be replaced, it releases the module without tools and allows easy removal. By using the double terminals



suitable for all conductors, the arresters can be connected in series in a space-saving and cost-effective way up to nominal currents of 125 A as preferred by IEC 60364-5-53. Busbars of type MVS 3 8 6 and MVS 4 11 8 can be used for connecting further DIN rail mounted devices. The type designation of DEHNventil arresters allows to easily choose the right arrester for the relevant system configuration of the low-voltage consumer's installation.

The patented RADAX Flow technology for follow current limitation and extinction allows high availability of the electrical consumer's installation to be protected. Even in case of short-circuit currents as high as 100 kA_{rms}, mains follow currents are reduced in such a way that selectivity with respect to low-current-rated fuses is ensured. This means that upstream fuses will not trip due to upcoming mains follow currents.

The operating state/fault indicator of each protective path needs no power to operate and instantly shows the operating state of the surge arrester. Apart from the standard visual indicator with green and red indicator flags, DEHNventil M ... FM devices feature a three-pole remote signalling terminal. With its floating changeover contact, the remote signal can be used as a break or make contact according to the particular circuit concept.

Due to their parameters and design, the devices can be even installed upstream of meter panels in low-voltage consumer's installations.

DEHNventil M TNC (FM)

Modular combined lightning current and surge arrester for TN-C systems with a nominal voltage of 230/400 V (3+0 configuration); FM version with floating remote signalling contact.

Type DV M ...	TNC 255	TNC 255 FM
Part No.	951 300	951 305
SPD according to EN 61643-11 / IEC 61643-11	type 1 + type 2 / class I + class II	type 1 + type 2 / class I + class II
Max. continuous operating voltage (a.c.) (U_c)	264 V (50 / 60 Hz)	264 V (50 / 60 Hz)
Lightning impulse current (10/350 μ s) [L1+L2+L3-PEN] (I_{total})	75 kA	75 kA
Lightning impulse current (10/350 μ s) [L-PEN] (I_{imp})	25 kA	25 kA
Voltage protection level (U_p)	≤ 1.5 kV	≤ 1.5 kV
Max. backup fuse (L) up to $I_K = 50$ kA _{rms}	315 A gG	315 A gG
Approvals	KEMA, VDE, UL	KEMA, VDE, UL
Type of remote signalling contact	—	changeover contact
Extended technical data:	For use in switchgear installations with prospective short-circuit currents of more than 50 kA_{rms} (tested by the German VDE)	
– Max. prospective short-circuit current	100 kA _{rms} (220 kA _{peak})	100 kA _{rms} (220 kA _{peak})



DEHNventil M TNS (FM)

Modular combined lightning current and surge arrester for TN-S systems with a nominal voltage of 230/400 V (4+0 configuration); FM version with floating remote signalling contact.

Type DV M ...	TNS 255	TNS 255 FM
Part No.	951 400	951 405
SPD according to EN 61643-11 / IEC 61643-11	type 1 + type 2 / class I + class II	type 1 + type 2 / class I + class II
Max. continuous operating voltage (a.c.) (U_c)	264 V (50 / 60 Hz)	264 V (50 / 60 Hz)
Lightning impulse current (10/350 μ s) [L1+L2+L3+N-PE] (I_{total})	100 kA	100 kA
Lightning impulse current (10/350 μ s) [L, N-PE] (I_{imp})	25 kA	25 kA
Voltage protection level [L-PE]/[N-PE] (U_p)	$\leq 1.5 / \leq 1.5$ kV	$\leq 1.5 / \leq 1.5$ kV
Max. backup fuse (L) up to $I_K = 50$ kA _{rms}	315 A gG	315 A gG
Approvals	KEMA, VDE, UL	KEMA, VDE, UL
Type of remote signalling contact	—	changeover contact
Extended technical data:	For use in switchgear installations with prospective short-circuit currents of more than 50 kA_{rms} (tested by the German VDE)	
– Max. prospective short-circuit current	100 kA _{rms} (220 kA _{peak})	100 kA _{rms} (220 kA _{peak})



DEHNventil M TT (FM)

Modular combined lightning current and surge arrester for TT and TN-S systems with a nominal voltage of 230/400 V (3+1 configuration); FM version with floating remote signalling contact.

Type DV M ...	TT 255	TT 255 FM
Part No.	951 310	951 315
SPD according to EN 61643-11 / IEC 61643-11	type 1 + type 2 / class I + class II	type 1 + type 2 / class I + class II
Max. continuous operating voltage (a.c.) [L-N] (U_c)	264 V (50 / 60 Hz)	264 V (50 / 60 Hz)
Lightning impulse current (10/350 μ s) [L1+L2+L3+N-PE] (I_{total})	100 kA	100 kA
Lightning impulse current (10/350 μ s) [L-N]/[N-PE] (I_{imp})	25 / 100 kA	25 / 100 kA
Voltage protection level [L-N]/[N-PE] (U_p)	$\leq 1.5 / \leq 1.5$ kV	$\leq 1.5 / \leq 1.5$ kV
Max. backup fuse (L) up to $I_K = 50$ kA _{rms}	315 A gG	315 A gG
Approvals	KEMA, VDE, UL	KEMA, VDE, UL
Type of remote signalling contact	—	changeover contact
Extended technical data:	For use in switchgear installations with prospective short-circuit currents of more than 50 kA_{rms} (tested by the German VDE)	
Voltage protection level [L-PE] (U_p)	2.2 kV	2.2 kV
– Max. prospective short-circuit current	100 kA _{rms} (220 kA _{peak})	100 kA _{rms} (220 kA _{peak})



DEHNventil M TN (FM)

Modular combined lightning current and surge arrester for single-phase TN systems with a nominal voltage of 230 V (2+0 configuration); FM version with floating remote signalling contact.



Type DV M ...	TN 255	TN 255 FM
Part No.	951 200	951 205
SPD according to EN 61643-11 / IEC 61643-11	type 1 + type 2 / class I + class II	type 1 + type 2 / class I + class II
Max. continuous operating voltage (a.c.) (U_c)	264 V (50 / 60 Hz)	264 V (50 / 60 Hz)
Lightning impulse current (10/350 μ s) [L+N-PE] (I_{total})	50 kA	50 kA
Lightning impulse current (10/350 μ s) [L, N-PE] (I_{imp})	25 kA	25 kA
Voltage protection level [L-PE]/[N-PE] (U_p)	$\leq 1.5 / \leq 1.5$ kV	$\leq 1.5 / \leq 1.5$ kV
Max. backup fuse (L) up to $I_k = 50$ kA _{rms}	315 A gG	315 A gG
Approvals	KEMA, VDE, UL	KEMA, VDE, UL
Type of remote signalling contact	—	changeover contact
Extended technical data:	For use in switchgear installations with prospective short-circuit currents of more than 50 kA_{rms} (tested by the German VDE)	
– Max. prospective short-circuit current	100 kA _{rms} (220 kA _{peak})	100 kA _{rms} (220 kA _{peak})

DEHNventil M TT 2P (FM)

Modular combined lightning current and surge arrester for single-phase TT and TN-S systems with a nominal voltage of 230 V (1+1 configuration); FM version with floating remote signalling contact.



Type DV M ...	TT 2P 255	TT 2P 255 FM
Part No.	951 110	951 115
SPD according to EN 61643-11 / IEC 61643-11	type 1 + type 2 / class I + class II	type 1 + type 2 / class I + class II
Max. continuous operating voltage (a.c.) [L-N] (U_c)	264 V (50 / 60 Hz)	264 V (50 / 60 Hz)
Lightning impulse current (10/350 μ s) [L+N-PE] (I_{total})	50 kA	50 kA
Lightning impulse current (10/350 μ s) [L-N]/[N-PE] (I_{imp})	25 / 50 kA	25 / 50 kA
Voltage protection level [L-N]/[N-PE] (U_p)	$\leq 1.5 / \leq 1.5$ kV	$\leq 1.5 / \leq 1.5$ kV
Max. backup fuse (L) up to $I_k = 50$ kA _{rms}	315 A gG	315 A gG
Approvals	KEMA, VDE, UL	KEMA, VDE, UL
Type of remote signalling contact	—	changeover contact
Extended technical data:	For use in switchgear installations with prospective short-circuit currents of more than 50 kA_{rms} (tested by the German VDE)	
Voltage protection level [L-PE] (U_p)	2.2 kV	2.2 kV
– Max. prospective short-circuit current	100 kA _{rms} (220 kA _{peak})	100 kA _{rms} (220 kA _{peak})

Protection Module for DEHNventil® modular

- High discharge capacity due to powerful creepage discharge spark gap
- Maximum system availability due to RADAX Flow follow current limitation
- Easy replacement of protection modules without tools due to module locking system with module release button
- Operating state / fault indication by green / red indicator flag in the inspection window
- The plug-in protection module can be replaced without the need to de-energise and without removing the distribution board cover



For protecting low-voltage consumer's installations against surges and even direct lightning strikes. For installation in conformity with the lightning protection zone concept at the boundaries from 0_A–2.

- DV MOD 255: Spark-gap-based protection module
- DV MOD NPE 50: 50 kA N-PE spark-gap-based protection module
- DV MOD NPE 100: 100 kA N-PE spark-gap-based protection module

The spark-gap-based protection modules of the modular DEHNventil series combine safety and innovation in a single device. Apart from the encapsulated RADAX Flow spark gap technology, the compact protection modules incorporate the complete monitoring circuit for controlling the energy flow of the spark gap, the monitoring device and the operating state/fault indicator.

The mechanical coding of the protection module prevents that the N-PE protection modules are confused with the spark-gap-based module for the phase conductors.

The module locking mechanism fixes the protection modules to the base part. Protection modules can be easily removed without tools by simply pressing the module release button.

Avoid additional, short-notice and unplanned maintenance jobs. In multipole protective circuits, we recommend replacing the complete set of protection modules when one module fails.



Spark-Gap-Based Protection Module

Spark-gap-based protection module for DEHNventil M ...

Type DV MOD ...	255
Part No.	951 001
Max. continuous operating voltage (a.c.) (U _c)	264 V
Lightning impulse current (10/350 μs) (I _{imp})	25 kA



N-PE Spark-Gap-Based Protection Module

N-PE spark-gap-based protection module for DEHNventil M ... with ... + 1 configuration.

Type DV MOD ...	NPE 50	NPE 100
Part No.	951 050	951 100
Max. continuous operating voltage (a.c.) (U _c)	255 V	255 V
Lightning impulse current (10/350 μs) (I _{imp})	50 kA	100 kA





DEHNvenCI



- Spark-gap based combined lightning current and surge arrester with integrated lightning current carrying backup fuse
- Energy coordination with other arresters of the Red/Line product family
- Low voltage protection level $U_p \leq 1.5$ kV (including backup fuse)
- Maximum system availability due to RADAX Flow follow current limitation
- Extinction of mains follow currents up to 100 kA_{rms}
- High lightning current discharge capacity of 25 kA (10/350 μ s)
- Capable of protecting terminal equipment
- Operating state/fault indication by green/red indicator flag in the inspection window

For protecting low-voltage consumer's installations against surges and even direct lightning strikes. For installation in conformity with the lightning protection zone concept at the boundaries from $0_A - 2$.

DEHNvenCI 1 255: Single-pole combined lightning current and surge arrester with integrated backup fuse

DEHNvenCI 1 255 FM: With remote signalling contact for monitoring device (floating changeover contact)

Featuring the functional Red/Line family design, coordinated DEHNvenCI combined lightning current and surge arresters provide maximum system protection and take up little space. The features of the practice-proven DEHNventil family were combined with a lightning current carrying arrester backup fuse in an enclosure with a width of only two modules.

With switchgear installations getting more and more compact, it is difficult to install lightning current arresters in conformity with the standard. DEHNvenCI arresters allow space-saving integration of a combined lightning current and surge arrester and are said to meet the protection requirements of modern switchgear installations. The integrated arrester backup fuse is dimensioned to ensure maximum discharge capacity and optimal system protection.

The need to select and install an arrester backup fuse is eliminated, ensuring short connecting cable lengths as required in IEC 60364-5-53.

Consequently, DEHNvenCI is an efficient combined arrester which is easy to install.

The energy-coordinated arresters even allow protection of terminal devices or sensitive electronic systems in modern switchgear installations if the distance between DEHNvenCI and the loads is ≤ 10 m.

The patented RADAX Flow technology for follow current limitation and extinction allows high availability of the electrical consumer's installation to be protected.

Even in case of short-circuit currents as high as 100 kA_{rms}, DEHNvenCI can be used in industrial systems without restrictions.

The ability to carry lightning impulse currents without destruction and simultaneously reduce the energy to an acceptable level for terminal devices ensures the availability of the switchgear installation in case of a lightning strike. This considerably reduces the risk of high-loss failures.

The operating state/fault indicator of DEHNvenCI, which houses the fuse monitoring system and needs no power to operate, shows the operating state of the arrester. Apart from the standard visual indicator with green and red indicator flags, DEHNvenCI 1 255 FM devices feature a three-pole remote signalling terminal. With its floating changeover contact, the remote signal can be used as a break or make contact according to the particular circuit concept.

Combined Arresters – Type 1

DEHNvenCI 255 (FM)

Single-pole combined lightning current and surge arrester with integrated lightning current carrying backup fuse for use in 230/400 V systems; FM version with floating remote signalling contact.

Type DVCI 1 ...	255	255 FM
Part No.	961 200	961 205
SPD according to EN 61643-11 / IEC 61643-11	type 1 / class I	type 1 / class I
Maximum continuous operating voltage (a.c.) (U_c)	255 V (50 / 60 Hz)	255 V (50 / 60 Hz)
Lightning impulse current (10/350 μ s) (I_{imp})	25 kA	25 kA
Voltage protection level (U_p)	≤ 1.5 kV	≤ 1.5 kV
Max. mains-side overcurrent protection	not required	not required
Approvals	KEMA	KEMA
Type of remote signalling contact	—	changeover contact
Extended technical data:	For use in switchgear installations with prospective short-circuit currents of more than 50 kA_{rms} (tested by the German VDE)	
– Max. prospective short-circuit current	100 kA _{rms} (220 kA _{peak})	100 kA _{rms} (220 kA _{peak})



Accessories for DEHNvenCI

Earthing Clip for two-module Enclosures, single-phase, two-pole

Earthing clip for connecting the earth terminal of e.g. two SPDs with two-module enclosure to earth, with terminal.

Type	EB 1 2 5
Part No.	900 419
Dimensions	34 x 77 x 28 mm
Terminal	up to 25 mm ²



Earthing Clip for two-module Enclosures, single-phase, three-pole

Earthing clip for connecting the earth terminal of e.g. three SPDs with two-module enclosure to earth, with terminal.

Type	EB DG 1000 1 3
Part No.	900 411
Dimensions	34 x 112 x 28 mm
Terminal	up to 25 mm ²



Earthing Clip for two-module Enclosures, single-phase, four-pole

Earthing clip for connecting the earth terminal of e.g. four SPDs with two-module enclosure to earth, with terminal.

Type	EB 1 4 9
Part No.	900 417
Dimensions	34 x 148 x 28 mm
Terminal	up to 25 mm ²



DEHNshield®



- Application-optimised and prewired spark-gap-based type 1 + type 2 combined lightning current and surge arrester
- Compact design due to space-saving spark gap technology with a width of only one module / pole
- Fulfils the minimum requirements on the lightning current discharge capacity according to IEC 60364-5-53
- Allows compact lightning equipotential bonding including protection of terminal equipment
- Discharge capacity up to 50 kA (10/350 μ s)
- Operating state / fault indication by green / red indicator flag in the inspection window
- High follow current extinguishing capacity ($I_{fi} = 25 \text{ kA}_{rms}$)

For protecting compact low-voltage consumer's installations against surges and even direct lightning strikes. For installation in conformity with the lightning protection zone concept at the boundaries from $0_A - 2$.

- DEHNshield TNC 255: Application-optimised combined lightning current and surge arrester for TN-C systems
- DEHNshield TNS 255: Application-optimised combined lightning current and surge arrester for TN-S systems
- DEHNshield TT 255: Application-optimised combined lightning current and surge arrester for TT and TN-S systems (3+1 configuration)
- DEHNshield TN 255: Application-optimised combined lightning current and surge arrester for single-phase TN systems
- DEHNshield TT 2P 255: Application-optimised combined lightning current and surge arrester for single-phase TT and TN systems (1+1 configuration)
- DEHNshield ... FM: With remote signalling contact for monitoring device (floating changeover contact)

The space-saving and application-optimised DEHNshield family offers various benefits provided by type 1 + type 2 spark-gap-based arresters such as the "wave breaker function" (WBF). This function and the associated reduction of the pulse time mitigate the energy of the lightning impulse current to an acceptable level for downstream protection stages or terminal equipment. Moreover, DEHNshield arresters are directly energy coordinated with other arresters of the Red/Line product family.

Application-optimised DEHNshield combined lightning current and surge arresters combine lightning equipotential bonding up to lightning impulse currents of 50 kA (10/350 μ s) and surge protection in a single device.

This clearly distinguishes DEHNshield from varistor-based arresters of this application and performance class.

Due to their technical parameters and the very compact design as spark-gap-based arrester with only one module / pole, DEHNshield arresters are ideally suited for this application class. For this reason, they are a space-saving and application-optimised solution in particular for residential buildings.

DEHNshield arresters also provide optimal protection in existing buildings without external lightning protection system where roof superstructures or overhead line supplies are installed which require type 1 SPDs according to VdS 2031.

No additional backup fuse is required if an installation is protected by backup fuses up to 160 A.

The energy-coordinated arresters even allow to protect terminal equipment if the distance between DEHNshield and the loads is $\leq 10 \text{ m}$. The spark gap without venting means and the small space requirements of the application-optimised combined lightning current and surge arresters enable easy integration into distribution boards.

The follow-current-limiting spark gap technology ensures selectivity with regard to low-current-rated fuses (35 A gG). This means that upstream fuses will not trip due to mains follow currents.

Busbars and pin-shaped terminals from DEHN + SÖHNE can be used for connecting DEHNshield to other DIN rail mounted devices. The type designation of DEHNshield allows to easily choose the right arrester for the relevant system configuration of the low-voltage consumer's installation.

The operating state / fault indicator of every protective path needs no power to operate and instantly shows the operating state of the arrester. Apart from the standard visual indicator with green and red indicator flags, the DEHNshield ... FM versions feature a three-pole remote signalling terminal. With its floating changeover contact, the remote signal can be used as a break or make contact according to the particular circuit concept.

Due to their parameters and design, the DEHNshield devices can be even installed upstream of meter panels in low-voltage consumer's installations.



Series connection by means of a lightning-current-tested STAK 25 pin-shaped terminal

DEHNshield TNC

Application-optimised and prewired combined lightning current and surge arrester for TN-C systems with a nominal voltage of 230/400 V (3+0 configuration).

Type DSH ...	TNC 255
Part No.	941 300
SPD according to EN 61643-11 / IEC 61643-11	type 1 + type 2 / class I + class II
Max. continuous operating voltage (a.c.) (U_c)	255 V (50 / 60 Hz)
Lightning impulse current (10/350 μ s) [L1+L2+L3-PEN] (I_{total})	37.5 kA
Lightning impulse current (10/350 μ s) [L-PEN] (I_{imp})	12.5 kA
Voltage protection level (U_p)	≤ 1.5 kV
Max. mains-side overcurrent protection	160 A gG
Approvals	KEMA, VDE, UL



DEHNshield TNC FM

Application-optimised and prewired combined lightning current and surge arrester for TN-C systems with a nominal voltage of 230/400 V (3+0 configuration); with floating remote signalling contact.

Type DSH ...	TNC 255 FM
Part No.	941 305
SPD according to EN 61643-11 / IEC 61643-11	type 1 + type 2 / class I + class II
Max. continuous operating voltage (a.c.) (U_c)	255 V (50 / 60 Hz)
Lightning impulse current (10/350 μ s) [L1+L2+L3-PEN] (I_{total})	37.5 kA
Lightning impulse current (10/350 μ s) [L-PEN] (I_{imp})	12.5 kA
Voltage protection level (U_p)	≤ 1.5 kV
Max. mains-side overcurrent protection	160 A gG
Approvals	KEMA, VDE
Type of remote signalling contact	changeover contact



DEHNshield TNC Basic FM

Application-optimised and prewired combined lightning current and surge arrester for TN-C systems; with floating remote signalling contact.

Type DSH ...	B TNC 255 FM
Part No.	941 306 ^{NEW}
SPD according to EN 61643-11 / IEC 61643-11	type 1 + type 2 / class I + class II
Max. continuous operating voltage (a.c.) (U_c)	255 V (50 / 60 Hz)
Lightning impulse current (10/350 μ s) [L1+L2+L3-PEN] (I_{total})	22.5 kA
Lightning impulse current (10/350 μ s) [L-PEN] (I_{imp})	7.5 kA
Voltage protection level (U_p)	≤ 1.5 kV
Max. mains-side overcurrent protection	160 A gG
Approvals	VDE
Type of remote signalling contact	changeover contact



DEHNshield TNS

Application-optimised and prewired combined lightning current and surge arrester for TN-S systems with a nominal voltage of 230/400 V (4+0 configuration).

Type DSH ...	TNS 255
Part No.	941 400
SPD according to EN 61643-11 / IEC 61643-11	type 1 + type 2 / class I + class II
Max. continuous operating voltage (a.c.) (U_c)	255 (50 / 60 Hz)
Lightning impulse current (10/350 μ s) [L1+L2+L3+N-PE] (I_{total})	50 kA
Lightning impulse current (10/350 μ s) [L, N-PE] (I_{imp})	12.5 kA
Voltage protection level [L-PE]/[N-PE] (U_p)	$\leq 1.5 / \leq 1.5$ kV
Max. mains-side overcurrent protection	160 A gG
Approvals	KEMA, VDE, UL



DEHNshield TNS FM

Application-optimised and prewired combined lightning current and surge arrester for TN-S systems with a nominal voltage of 230/400 V (4+0 configuration); with floating remote signalling contact.



Type DSH ...	TNS 255 FM
Part No.	941 405
SPD according to EN 61643-11 / IEC 61643-11	type 1 + type 2 / class I + class II
Max. continuous operating voltage (a.c.) (U _c)	255 (50 / 60 Hz)
Lightning impulse current (10/350 μs) [L1+L2+L3+N-PE] (I _{total})	50 kA
Lightning impulse current (10/350 μs) [L, N-PE] (I _{imp})	12.5 kA
Voltage protection level [L-PE]/[N-PE] (U _p)	≤ 1.5 / ≤ 1.5 kV
Max. mains-side overcurrent protection	160 A gG
Approvals	KEMA, VDE
Type of remote signalling contact	changeover contact

DEHNshield TNS Basic FM

Application-optimised and prewired combined lightning current and surge arrester for TN-S systems; with floating remote signalling contact.



Type DSH ...	B TNS 255 FM
Part No.	941 406 ^{NEW}
SPD according to EN 61643-11 / IEC 61643-11	type 1 + type 2 / class I + class II
Max. continuous operating voltage (a.c.) (U _c)	255 (50 / 60 Hz)
Lightning impulse current (10/350 μs) [L1+L2+L3+N-PE] (I _{total})	30 kA
Lightning impulse current (10/350 μs) [L, N-PE] (I _{imp})	7.5 kA
Voltage protection level [L-PE]/[N-PE] (U _p)	≤ 1.5 / ≤ 1.5 kV
Max. mains-side overcurrent protection	160 A gG
Approvals	VDE
Type of remote signalling contact	changeover contact

DEHNshield TT

Application-optimised and prewired combined lightning current and surge arrester for TT and TN-S systems with a nominal voltage of 230/400 V (3+1 configuration).



Type DSH ...	TT 255
Part No.	941 310
SPD according to EN 61643-11 / IEC 61643-11	type 1 + type 2 / class I + class II
Max. continuous operating voltage (a.c.) (U _c)	255 V (50 / 60 Hz)
Lightning impulse current (10/350 μs) [L1+L2+L3+N-PE] (I _{total})	50 kA
Lightning impulse current (10/350 μs) [L-N]/[N-PE] (I _{imp})	12.5 / 50 kA
Voltage protection level [L-N]/[N-PE] (U _p)	≤ 1.5 / ≤ 1.5 kV
Max. mains-side overcurrent protection	160 A gG
Approvals	KEMA, VDE, UL
Extended technical data:	
Voltage protection level [L-PE] (U _p)	2.0 kV

DEHNshield TT FM

Application-optimised and prewired combined lightning current and surge arrester for TT and TN-S systems with a nominal voltage of 230/400 V (3+1 configuration); with floating signalling contact.



Type DSH ...	TT 255 FM
Part No.	941 315
SPD according to EN 61643-11 / IEC 61643-11	type 1 + type 2 / class I + class II
Max. continuous operating voltage (a.c.) (U _c)	255 V (50 / 60 Hz)
Lightning impulse current (10/350 μs) [L1+L2+L3+N-PE] (I _{total})	50 kA
Lightning impulse current (10/350 μs) [L-N]/[N-PE] (I _{imp})	12.5 / 50 kA
Voltage protection level [L-N]/[N-PE] (U _p)	≤ 1.5 / ≤ 1.5 kV
Max. mains-side overcurrent protection	160 A gG
Approvals	KEMA, VDE
Type of remote signalling contact	changeover contact
Extended technical data:	
Voltage protection level [L-PE] (U _p)	2.0 kV

DEHNshield TT Basic FM

Application-optimised and prewired combined lightning current and surge arrester for TT and TN-S systems (3+1 configuration); with floating remote signalling contact.

Type DSH ...	B TT 255 FM
Part No.	941 316 ^{NEW}
SPD according to EN 61643-11 / IEC 61643-11	type 1 + type 2 / class I + class II
Max. continuous operating voltage (a.c.) (U_c)	255 V (50 / 60 Hz)
Lightning impulse current (10/350 μ s) [L1+L2+L3+N-PE] (I_{total})	30 kA
Lightning impulse current (10/350 μ s) [L-N]/[N-PE] (I_{imp})	7.5 / 30 kA
Voltage protection level [L-N]/[N-PE] (U_p)	$\leq 1.5 / \leq 1.5$ kV
Max. mains-side overcurrent protection	160 A gG
Approvals	VDE
Type of remote signalling contact	changeover contact
Extended technical data:	
Voltage protection level [L-PE] (U_p)	2.0 kV



DEHNshield TN

Application-optimised and prewired combined lightning current and surge arrester for single-phase TN systems with a nominal voltage of 230 V (2+0 configuration).

Type DSH ...	TN 255
Part No.	941 200
SPD according to EN 61643-11 / IEC 61643-11	type 1 + type 2 / class I + class II
Max. continuous operating voltage (a.c.) (U_c)	255 V (50 / 60 Hz)
Lightning impulse current (10/350 μ s) [L+N-PE] (I_{total})	25 kA
Lightning impulse current (10/350 μ s) [L, N-PE] (I_{imp})	12.5 kA
Voltage protection level [L-PE]/[N-PE] (U_p)	$\leq 1.5 / \leq 1.5$ kV
Max. mains-side overcurrent protection	160 A gG
Approvals	KEMA, VDE, UL



DEHNshield TN FM

Application-optimised and prewired combined lightning current and surge arrester for single-phase TN systems with a nominal voltage of 230 V (2+0 configuration); with floating remote signalling contact.

Type DSH ...	TN 255 FM
Part No.	941 205
SPD according to EN 61643-11 / IEC 61643-11	type 1 + type 2 / class I + class II
Max. continuous operating voltage (a.c.) (U_c)	255 V (50 / 60 Hz)
Lightning impulse current (10/350 μ s) [L+N-PE] (I_{total})	25 kA
Lightning impulse current (10/350 μ s) [L, N-PE] (I_{imp})	12.5 kA
Voltage protection level [L-PE]/[N-PE] (U_p)	$\leq 1.5 / \leq 1.5$ kV
Max. mains-side overcurrent protection	160 A gG
Approvals	KEMA, VDE
Type of remote signalling contact	changeover contact



DEHNshield TN Basic FM

Application-optimised and prewired combined lightning current and surge arrester for single-phase TN systems; with floating remote signalling contact.

Type DSH ...	B TN 255 FM
Part No.	941 206 ^{NEW}
SPD according to EN 61643-11 / IEC 61643-11	type 1 + type 2 / class I + class II
Max. continuous operating voltage (a.c.) (U_c)	255 V (50 / 60 Hz)
Lightning impulse current (10/350 μ s) [L+N-PE] (I_{total})	15 kA
Lightning impulse current (10/350 μ s) [L, N-PE] (I_{imp})	7.5 kA
Voltage protection level [L-PE]/[N-PE] (U_p)	$\leq 1.5 / \leq 1.5$ kV
Max. mains-side overcurrent protection	160 A gG
Type of remote signalling contact	changeover contact



DEHNshield TT 2P

Application-optimised and prewired combined lightning current and surge arrester for single-phase TT and TN systems with a nominal voltage of 230 V (1+1 configuration).



Type DSH ...	TT 2P 255
Part No.	941 110
SPD according to EN 61643-11 / IEC 61643-11	type 1 + type 2 / class I + class II
Max. continuous operating voltage (a.c.) (U _c)	255 V (50 / 60 Hz)
Lightning impulse current (10/350 μs) [L+N-PE] (I _{total})	25 kA
Lightning impulse current (10/350 μs) [L-N]/[N-PE] (I _{imp})	12.5 / 25 kA
Voltage protection level [L-N]/[N-PE] (U _p)	≤ 1.5 / ≤ 1.5 kV
Max. mains-side overcurrent protection	160 A gG
Approvals	KEMA, VDE, UL
Extended technical data:	
Voltage protection level [L-PE] (U _p)	2.0 kV

DEHNshield TT 2P FM

Application-optimised and prewired combined lightning current and surge arrester for single-phase TT and TN systems with a nominal voltage of 230 V (1+1 configuration); with floating remote signalling contact.



Type DSH ...	TT 2P 255 FM
Part No.	941 115
SPD according to EN 61643-11 / IEC 61643-11	type 1 + type 2 / class I + class II
Max. continuous operating voltage (a.c.) (U _c)	255 V (50 / 60 Hz)
Lightning impulse current (10/350 μs) [L+N-PE] (I _{total})	25 kA
Lightning impulse current (10/350 μs) [L-N]/[N-PE] (I _{imp})	12.5 / 25 kA
Voltage protection level [L-N]/[N-PE] (U _p)	≤ 1.5 / ≤ 1.5 kV
Max. mains-side overcurrent protection	160 A gG
Approvals	KEMA, VDE
Type of remote signalling contact	changeover contact
Extended technical data:	
Voltage protection level [L-PE] (U _p)	2.0 kV

DEHNshield TT 2P Basic FM

Application-optimised and prewired combined lightning current and surge arrester for single-phase TT and TN-S systems (1+1 configuration); with floating remote signalling contact.

NEW



Type DSH ...	B TT 2P 255 FM
Part No.	941 116 ^{NEW}
SPD according to EN 61643-11 / IEC 61643-11	type 1 + type 2 / class I + class II
Max. continuous operating voltage (a.c.) (U _c)	255 V (50 / 60 Hz)
Lightning impulse current (10/350 μs) [L+N-PE] (I _{total})	15 kA
Lightning impulse current (10/350 μs) [L-N]/[N-PE] (I _{imp})	7.5 / 15 kA
Voltage protection level [L-N]/[N-PE] (U _p)	≤ 1.5 / ≤ 1.5 kV
Max. mains-side overcurrent protection	160 A gG
Type of remote signalling contact	changeover contact
Extended technical data:	
Voltage protection level [L-PE] (U _p)	2.0 kV

DEHNcombo

- Prewired type 1 + type 2 combined lightning current and surge arrester for use in photovoltaic generator circuits
- Combined disconnection and short-circuiting device with safe electrical isolation (patented SCI principle)
- Approved fault-resistant Y circuit prevents damage to the surge protective device in case of insulation faults in the generator circuit
- Space-saving enclosure with a width of only four modules for up to 1500 V d.c.
- Tested to EN 50539-11
- Suitable for use in all PV systems in accordance with IEC 60364-7-712
- Operating state/fault indication by green/red indicator flag in the inspection window



For protecting photovoltaic inverters against surges and even direct lightning strikes. For use in accordance with IEC 60364-7-712 (Installation of photovoltaic power supply systems).

Combined Arresters – Type 1 + Type 2

- DEHNcombo YPV SCI 600:** Two-pole combined lightning current and surge arrester for use in photovoltaic power supply systems up to 600 V d.c.
- DEHNcombo YPV SCI 1000:** Two-pole combined lightning current and surge arrester for use in photovoltaic power supply systems up to 1000 V d.c.
- DEHNcombo YPV SCI 1500:** Two-pole combined lightning current and surge arrester for use in photovoltaic power supply systems up to 1500 V d.c.
- DEHNcombo YPV SCI ... FM:** With remote signalling contact for monitoring device (floating changeover contact)

The DEHNcombo YPV SCI ... combined arrester protects equipment in photovoltaic systems against lightning currents.

Thanks to its application-optimised discharge capacity of 6.25 kA (10/350 μ s) per pole, DEHNcombo is tailored to meet the requirements of the latest version of the EN 50539-12 standard and Supplement 5 of the German DIN EN 62305-3 standard.

With a short-circuit current rating of 1000 A, DEHNcombo easily meets all requirements placed on surge arresters in small, medium and large photovoltaic systems and can be used without additional backup fuse in all photovoltaic systems up to 1000 A.

Due to its enclosure design which is specifically adapted to the system-specific requirements, even the version for voltages up to 1500 V can be used without taking special precautions (e.g. safety distances). The combined arrester has a width of only four modules, thus allowing space-saving installation.

The patented three-step d.c. switching device (SCI principle) provides an extremely high degree of safety which is required in modern photovoltaic systems. DEHNcombo YPV SCI is available for voltages of 600 V, 1000 V and 1500 V, covering the most common voltage levels of photovoltaic systems.

The fault-resistant Y circuit and the combined disconnection and short-circuiting device further reduce the probability of an arrester failure in case

of the operating and fault states which have to be considered in photovoltaic systems. This ensures reliable operation of the PV system at any time.

A low own consumption of the devices is also an important aspect in PV systems. The operating state/fault indication, which needs no power to operate and instantly provides information on the operating state of the arrester, also fulfils this requirement. With its optional floating changeover contact, the remote signal can be used as a break or make contact according to the particular circuit concept.

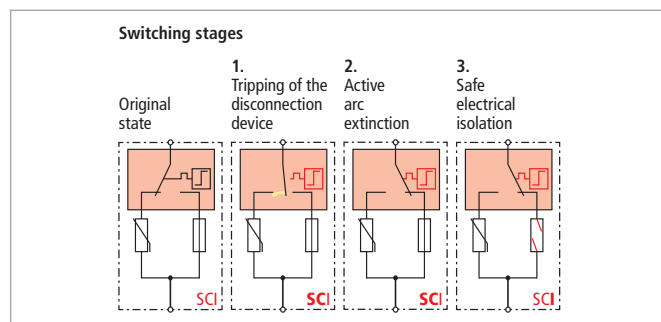

Three-step d.c. switching device (patented SCI principle)

DEHNcombo YPV SCI ... FM

Combined lightning current and surge arrester for use in photovoltaic power supply systems up to 1500 V d.c.; with floating remote signalling contact.

Type DCB YPV SCI ...	600	600 FM	1000	1000 FM	1500	1500 FM
Part No.	900 060	900 065	900 061	900 066	900 062	900 067
SPD according to EN 50539-11	type 1 + type 2	type 1 + type 2	type 1 + type 2	type 1 + type 2	type 1 + type 2	type 1 + type 2
Max. PV voltage [DC+ -> DC-] (U_{CPV})	≤ 600 V	≤ 600 V	≤ 1000 V	≤ 1000 V	≤ 1500 V	≤ 1500 V
Short-circuit current rating (I_{SCPV})	1000 A	1000 A	1000 A	1000 A	1000 A	1000 A
Total discharge current (10/350 μ s) [DC+/DC- -> PE] (I_{total})	12.5 kA	12.5 kA	12.5 kA	12.5 kA	12.5 kA	12.5 kA
Lightning impulse current (10/350 μ s) [DC+ -> PE/DC- -> PE] (I_{imp})	6.25 kA	6.25 kA	6.25 kA	6.25 kA	6.25 kA	6.25 kA
Voltage protection level [(DC+/DC-) -> PE] (U_p)	1.75 kV	1.75 kV	2.5 kV	2.5 kV	3.75 kV	3.75 kV
Approvals	KEMA, UL	KEMA, UL	KEMA, UL	KEMA, UL	KEMA	KEMA
Type of remote signalling contact	—	changeover contact	—	changeover contact	—	changeover contact





DEHN protects.®

DEHNSolid

- Coordinated spark-gap-based lightning current arrester
- Extremely high lightning current discharge capacity up to 200 kA (10/350 μ s)
- Low voltage protection level $U_p \leq 2.5$ kV
- Extremely robust design for installation on busbars or mounting plates



For protecting low-voltage consumer's installations against surges and even direct lightning strikes. For installation in conformity with the lightning protection zone concept at the boundaries from $0_A - 1$.

DSO 1 255: Coordinated single-pole lightning current arrester with an extremely high lightning current discharge capacity

The spark gap of the coordinated DEHNSolid lightning current arrester has an extremely high lightning current discharge capacity of 200 kA (10/350 μ s), making DEHNSolid the most powerful lightning current arrester currently available on the market. Consequently, a technical solution is now available for applications where such powerful surge protective devices are required. The device ensures lightning protection if the lightning current is not distributed and thus the full lightning current may flow through the surge protective device. If a lightning protection level higher than LPL I according to EN 62305 is to be expected, DEHNSolid offers adequate protection.

DEHNSolid features a robust design due to its extreme installation conditions and can be installed in two different ways. On the one hand, the arrester can be directly mounted on the busbar. This ensures a mechanically stable installation, which is required in case of such extreme lightning currents due to the high forces, and short low-impedance connections. On the other hand, the arrester can be screwed onto a mounting plate / fixing unit using the fixing lugs if it is not possible to install it on a busbar. Extremely short and robust connecting cables are required for this device to ensure mechanical strength of the entire arrangement and a minimum voltage drop on the connecting cables to achieve an optimal voltage protection level for the installation.

DEHNSolid 1 255

Coordinated single-pole lightning current arrester for use in 230/400 V systems; for installation on busbars or mounting plates.

Type	DSO 1 255
Part No.	900 230
Classification according to EN 61643-11 / IEC 61643-11	type 1 / class I
Max. continuous operating voltage (a.c.) (U_c)	255 V (50 / 60 Hz)
Lightning impulse current (10/350 μ s) (I_{imp})	200 kA
Voltage protection level (U_p)	≤ 2.5 kV
Max. mains-side overcurrent protection	160 A gG



DEHnbloc® modular

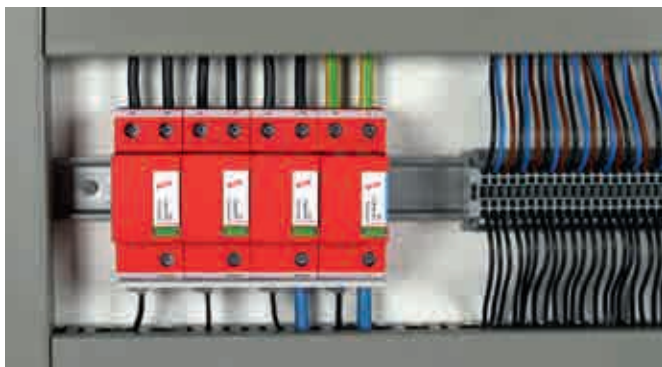

For protecting low-voltage consumer's installations against surges and even direct lightning strikes. For installation in conformity with the lightning protection zone concept at the boundaries from 0_A – 1.

- Coordinated spark-gap-based lightning current arrester consisting of a base part and a plug-in protection module
- Maximum system availability due to RADAX Flow follow current limitation
- No tripping of 32 A gG fuses up to short-circuit currents of 50 kA_{rms}
- Discharge capacity up to 50 kA (10/350 μs)
- Directly coordinated with DEHNguard surge protective devices without additional cable length
- Low voltage protection level
- Operating state / fault indication by green / red indicator flag in the inspection window
- Easy replacement of protection modules without tools due to module locking system with module release button

DEHnbloc M 1 ...: Coordinated and modular single-pole lightning current arrester with high follow current limitation
DEHnbloc M 1 ... FM: With remote signalling contact for monitoring device (floating changeover contact)

The modular devices of the DEHnbloc M product family are coordinated lightning current arresters with a functional design.

Energy coordination with type 2 surge arresters of the DEHNguard family is ensured without additional cable lengths or decoupling coils. This is one of the most important features of the Red/Line product families.

The DEHnbloc M arresters combine high performance and ease of use in a single device. Their electrical parameters are rated for the most stringent requirements within lightning and surge protection systems. DEHnbloc M is ideally suited for use in the main distribution board of the low-voltage consumer's installation of a building. Equipped with the latest RADAX Flow spark gap technology, the protection and availability of electrical installations is a top priority of DEHnbloc M.

Due to the unique follow current limitation and extinction, fuses are not tripped by follow currents even in case of low-current-rated fuses in the installation. The leakage-current-free protective circuit and the mechanical operating state indicator allow the device to be installed even in areas upstream of meter panels in low-voltage consumer's installations.

The modular design of the DEHnbloc M arresters makes them safe and easy to use. Their vibration-proof module locking system, for example, is unique. Shock or vibration during transport or operation or enormous mechanical impulse loads resulting from discharges do not affect the module locking system which ensures safe fixation both for the base part and protection module. Nevertheless, the protection modules can be eas-

ily replaced without tools by simply pressing the easy-to-use module release button. Both the base part and protection module are mechanically coded to ensure against installing an incorrect module.

DEHnbloc M devices incorporate double terminals, allowing series connection of the arresters in a space-saving and cost-effective way according to IEC 60364-5-53 requirements for nominal currents up to 125 A.

The operating state / fault indicator of DEHnbloc M needs no power to operate and instantly shows the operating state of the device. Apart from the standard visual indicator with red and green indicator flags, DEHnbloc M ... FM devices feature an additional remote signalling output. With its floating changeover contact, the remote signal can be used as a break or make contact according to the particular circuit concept.



DEHnbloc M 1 ...

Coordinated and modular single-pole lightning current arrester with a high discharge capacity.



Type DB M 1 ...	150	255	320
Part No.	961 110	961 120	961 130
SPD according to EN 61643-11 / IEC 61643-11	type 1 / class I	type 1 / class I	type 1 / class I
Max. continuous operating voltage (a.c.) (U _c)	150 V (50 / 60 Hz)	255 V (50 / 60 Hz)	320 V (50 / 60 Hz)
Lightning impulse current (10/350 μs) (I _{imp})	35 kA	50 kA	25 kA
Voltage protection level (U _p)	≤ 1.5 kV	≤ 2.5 kV	≤ 2.5 kV
Max. backup fuse (L) up to I _k = 50 kA _{rms} (t _a ≤ 0.2 s)	—	500 A gG	315 A gG
Max. backup fuse (L) up to I _k = 50 kA _{rms} (t _a ≤ 5 s)	—	315 A gG	315 A gG
Max. backup fuse (L) up to I _k = 35 kA _{rms} (t _a ≤ 0.2 s)	500 A gG	—	—
Max. backup fuse (L) up to I _k = 35 kA _{rms} (t _a ≤ 5 s)	315 A gG	—	—
Approvals	UL, CSA	VDE, KEMA, UL	UL

DEHNbloc M 1 ... FM

Coordinated and modular single-pole lightning current arrester with a high discharge capacity; with remote signalling contact for monitoring system (floating changeover contact).

Type DB M 1 ...	150 FM	255 FM	320 FM
Part No.	961 115	961 125	961 135
SPD according to EN 61643-11 / IEC 61643-11	type 1 / class I	type 1 / class I	type 1 / class I
Max. continuous operating voltage (a.c.) (U_c)	150 V (50 / 60 Hz)	255 V (50 / 60 Hz)	320 V (50 / 60 Hz)
Lightning impulse current (10/350 μ s) (I_{imp})	35 kA	50 kA	25 kA
Voltage protection level (U_p)	≤ 1.5 kV	≤ 2.5 kV	≤ 2.5 kV
Max. backup fuse (L) up to $I_K = 50$ kA _{rms} ($t_a \leq 0.2$ s)	—	500 A gG	315 A gG
Max. backup fuse (L) up to $I_K = 50$ kA _{rms} ($t_a \leq 5$ s)	—	315 A gG	315 A gG
Max. backup fuse (L) up to $I_K = 35$ kA _{rms} ($t_a \leq 0.2$ s)	500 A gG	—	—
Max. backup fuse (L) up to $I_K = 35$ kA _{rms} ($t_a \leq 5$ s)	315 A gG	—	—
Approvals	UL, CSA	VDE, KEMA, UL	UL



Protection Module for DEHNbloc® modular

- High discharge capacity due to powerful creepage discharge spark gap
- Maximum system availability due to RADAX Flow follow current limitation
- Easy replacement of protection modules without tools due to module locking system with module release button
- Operating state / fault indication by green / red indicator flag in the inspection window
- The plug-in protection module can be replaced without the need to de-energise and removing the vertical cover



For protecting low-voltage consumer's installations against surges and even direct lightning strikes. For installation in conformity with the lightning protection zone concept at the boundaries from $0_A - 1$.

DB M MOD ...: Spark-gap-based protection module

The spark-gap-based protection modules for devices of the DEHNbloc M family incorporate the complete protective circuit including the RADAX Flow spark gap and the monitoring circuit for controlling the energy flow. The spark gap monitoring system and the operating state / fault indicator are also housed in the protection module.

Every protection module is mechanically coded to ensure against installing an incorrect replacement module.

As with all modular protective devices, protection modules can be easily replaced without tools by simply pressing the module release button.

Avoid additional, short-notice and unplanned maintenance jobs. In multi-pole protective circuits, we recommend replacing the complete set of protection modules when one module fails.

DB M Spark-Gap-Based Protection Module

Spark-gap-based protection module for DEHNbloc M ...

Type DB M MOD ...	150	255	320
Part No.	961 001	961 002	961 003
Max. continuous operating voltage (a.c.) (U_c)	150 V	255 V	320 V
Lightning impulse current (10/350 μ s) (I_{imp})	35 kA	50 kA	25 kA





DEHNbloc® modular for North America



- High discharge current capacity due to powerful creepage discharge spark gap
- Directly coordinated with DEHNguard MU surge protective devices without additional cable length
- ANSI/UL 1449 – 4th Ed. open type 1 surge protection device (SPD)

DEHNbloc MU 3PY 208 3W+G R: Modular lightning current arrester for application in 3 phase Wye 208Y/120V electrical systems
 DEHNbloc MU 3PY 480 3W+G R: Modular lightning current arrester for application in 3 phase Wye 480Y/277V electrical systems
 DEHNbloc MU ... R: With remote status indicator for monitoring device (Form C / SPDT contact)

Lightning Current Arresters – Type 1

DEHNbloc MU 3PY ... 3W+G

DIN rail mount, pluggable lightning current arrester consisting of a base part and plug-in protection modules for application in 3 Phase Wye electrical systems.



Type DB MU 3PY ...	208 3W+G R	480 3W+G R
Part No.	908 505	908 506
SPD classification acc. to ANSI/UL 1449 4 th Ed.	Open-Type 1 SPD	Open-Type 1 SPD
Max. continuous operating voltage [L-G] / [L-L] (MCOV)	150 V a.c. / 260 V a.c.	320 V a.c. / 555 V a.c.
Lightning impulse current (10x350 μs) (I _{imp})	35 kA	25 kA
Voltage protection rating [L-G] / [L-L] (VPR)	1500 V _{pk} / 2500 V _{pk}	1800 V _{pk} / 3000 V _{pk}
Approvals	UL	UL
Remote status contact	Floating (dry), Form C (SPDT)	Floating (dry), Form C (SPDT)

DEHNbloc® Maxi

- Encapsulated RADAX Flow spark gap with high follow current limitation
- No tripping of 32 A gG fuses up to short-circuit currents of 50 kA_{rms}
- High lightning current discharge capacity
- Directly coordinated with DEHNguard ... and V(A) NH ... surge protective devices without additional cable length
- NH00 design
- Low voltage protection level



For protecting low voltage consumer's installations against surges and even direct lightning strikes. For installation in conformity with the lightning protection zone concept at the boundaries from 0_A– 1.

DBM NH00 255: Coordinated single-pole lightning current arrester in NH00 design with high follow current limitation for U_c = 255 V

The coordinated DEHNbloc Maxi ... lightning current arresters adapt themselves to every kind of application. Whether being used in an exposed position or in harsh industrial environments: DEHNbloc Maxi ... always offers the right solution. The single-pole devices are coordinated with the proven DEHNguard and V(A) NH surge arresters of the Red/Line family. Irrespective of cable lengths and without requiring additional decoupling coils, the surge protection concept can be adapted individually to the special conditions of the installation.

DEHNbloc Maxi arresters provide the patented encapsulated creepage discharge spark gap and RADAX Flow follow current limitation. This means that special safety distances from busbars or other equipment are not required and backup fuses are not tripped due to the lacking selectivity between the protective device and any overcurrent protection system, thus ensuring maximum system availability.

DEHNbloc Maxi NH00 255 was specifically designed for industrial distribution boards and supply systems and allows compact and space-saving installation in NH00 fuse holders or disconnectors depending on the particular system.

DEHNbloc Maxi NH00 255

Coordinated single-pole lightning current arrester in NH00 design for TN-C and TN-S systems with a nominal voltage of 230/400 V.

Type	DBM NH00 255
Part No.	900 255
SPD according to EN 61643-11 / IEC 61643-11	type 1 / class I
Max. continuous operating voltage (a.c.) (U _c)	255 V (50 / 60 Hz)
Lightning impulse current (10/350 μs) (I _{imp})	25 kA
Voltage protection level (U _p)	≤ 2.5 kV
Max. backup fuse (L) up to I _K = 50 kA _{rms}	315 A gG





DEHNbloc® Maxi 1 CI 440 / 760 FM



For protecting low-voltage consumer's installations against surges and even direct lightning strikes. For installation in conformity with the lightning protection zone concept at the boundaries from $0_A - 1$.

- Spark-gap-based lightning current arrester with integrated lightning current carrying backup fuse in a compact enclosure
- Extremely high lightning current discharge capacity of 35 kA (10/350 μ s)
- Low voltage protection level (including backup fuse)
- High follow current extinguishing capability and limitation thanks to RADAX Flow technology
- Energy coordination with other arresters of the Red/Line product family
- Operating state/fault indication by green/red indicator flag in the inspection window

DEHNbloc Maxi 1 CI 440 FM: Coordinated single-pole lightning current arrester with integrated backup fuse, high follow current extinguishing capability and remote signalling contact for monitoring device (floating changeover contact) for $U_c = 440$ V

DEHNbloc Maxi 1 CI 760 FM: Coordinated single-pole lightning current arrester with integrated backup fuse, high follow current extinguishing capability and remote signalling contact for monitoring device (floating changeover contact) for $U_c = 760$ V

The coordinated DEHNbloc Maxi CI 440 and 760 lightning current arresters are specifically designed for higher system voltages, thus efficiently protecting installations from the effects of direct lightning strikes and surges. The features of the proven DEHNbloc Maxi device series and a lightning current carrying arrester backup fuse are combined in the compact enclosure with a width of three standard modules and therefore the devices require up to 60 % less space than a conventional solution.

With system applications getting more and more compact, it is difficult to install lightning current arresters in conformity with the standard. DEHNbloc Maxi CI allows space-saving integration of a type 1 arrester and is said to meet the protection requirements of modern switchgear installations.

Typical fields of application of this arrester are industrial plants with common nominal voltages of 400/690 V, IT systems of the chemical industry with nominal voltages of 500 V a.c., protection of the transformer on the low-voltage side of wind turbines and protection of the a.c. side of central inverters of photovoltaic systems.

The integrated backup fuse is dimensioned to ensure maximum discharge capacity and optimal system protection. Consequently, the need to select and install an adequate arrester backup fuse is eliminated, ensuring short connecting cable lengths as required in the IEC 60364-5-53 standard.

The proven spark gaps with wave breaker function and RADAX Flow technology are the core of the coordinated DEHNbloc Maxi CI 440 and 760 lightning current arresters. In case of spark-gap-based type 1 arresters, the full current flows through the type 1 arrester during the discharge process;

similar to a wave breaker, the destructive energy is mitigated to a sufficiently low level, thus considerably relieving the downstream SPDs and the entire electrical installation. In addition to this wave breaker function, the RADAX Flow technology reduces and extinguishes mains follow currents to such a low level that even a 32 A gG fuse does not trip. This ensures high availability and longevity of the electrical installation.

The new enclosure concept allows flexible installation. Due to the typical installation environment, DEHNbloc Maxi CI is delivered with two mounting brackets so that the arresters can also be directly fixed on a mounting plate. However, the arresters can also be mounted on a DIN rail.

The operating state/fault indication of DEHNbloc Maxi CI, which also includes the fuse monitoring, needs no power to operate and instantly shows the status of the devices. Apart from the standard visual indicator with green and red flags, the devices feature a three-pole remote signalling terminal. With its floating changeover contact, the remote signal can be used as a break or make contact according to the particular circuit concept.



Flexible installation using mounting brackets

Coordinated Lightning Current Arresters – Type 1

DEHNbloc Maxi 1 CI 440 FM

Coordinated single-pole lightning current arrester with integrated backup fuse for 400/690 V TN systems and 400 V IT systems; with remote signalling contact for monitoring device (floating changeover contact).

Type DBM 1 CI ...	440 FM
Part No.	961 146
SPD according to EN 61643-11 / IEC 61643-11	type 1 / class I
Maximum continuous operating voltage (a.c.) (U_c)	440 V (50 / 60 Hz)
Lightning impulse current (10/350 μ s) (I_{imp})	35 kA
Voltage protection level (U_p)	≤ 2.5 kV
Max. mains-side overcurrent protection	not required
Type of remote signalling contact	changeover contact



DEHNbloc Maxi 1 CI 760 FM

Coordinated single-pole lightning current arrester with integrated backup fuse for 690 V TN/IT systems; with remote signalling contact for monitoring device (floating changeover contact).

Type DBM 1 CI ...	760 FM
Part No.	961 176
SPD according to EN 61643-11 / IEC 61643-11	type 1 / class I
Maximum continuous operating voltage (a.c.) (U_c)	760 V (50 / 60 Hz)
Lightning impulse current (10/350 μ s) (I_{imp})	35 kA
Voltage protection level (U_p)	≤ 4 kV
Max. mains-side overcurrent protection	not required
Type of remote signalling contact	changeover contact



Accessories for DEHNbloc® Maxi 1 CI 440 / 760 FM

Earthing Clip for three-module Enclosures, single-phase, three-pole

Earthing clip for connecting the earth terminal of e.g. three SPDs with three-module enclosure to earth, with terminal.

Type	EB 1 3 10
Part No.	900 461
Dimensions	34 x 158 x 28 mm
Terminal	up to 25 mm ²



Earthing Clip for three-module Enclosures, single-phase, four-pole

Earthing clip for connecting the earth terminal of e.g. four SPDs with three-module enclosure to earth, with terminal.

Type	EB 1 4 13
Part No.	900 462
Dimensions	34 x 212 x 28 mm
Terminal	up to 25 mm ²



DEHnbloc® Maxi 440 / 760

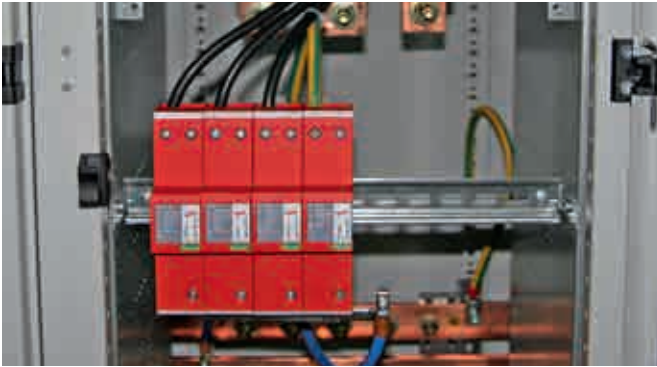

For protecting low-voltage consumer's installations against surges and even direct lightning strikes. For installation in conformity with the lightning protection zone concept at the boundaries from $0_A - 1$.

- Spark-gap-based lightning current arrester
- Extremely high lightning current discharge capacity
- High follow current extinguishing capability and limitation due RADAX Flow technology
- Directly coordinated with DEHNguard surge protective devices without additional cable length
- Operating state/fault indication by green/red indicator flag in the inspection window

- DEHnbloc Maxi 1 440:** Coordinated single-pole lightning current arrester with high follow current limitation for $U_c = 440$ V
DEHnbloc Maxi 1 440 FM: With remote signalling contact for monitoring device (floating changeover contact)
DEHnbloc Maxi 1 760 FM: Coordinated single-pole lightning current arrester with high follow current limitation for $U_c = 760$ V
 With remote signalling contact for monitoring device (floating changeover contact)

The coordinated DEHnbloc Maxi 440 and 760 lightning current arresters are specifically designed for high system voltages.

This allows to efficiently protect a variety of industrial applications from direct and indirect lightning currents.

Be it in a wind turbine or a stand-alone low-voltage installation of an industrial enterprise, DEHnbloc Maxi devices exactly fulfil the specific requirements.

Both the design of the protective circuit and the enclosure specifically designed for this type of arrester are particularly adapted to high system voltages.

The approved RADAX Flow technology is the essential core element of the coordinated DEHnbloc Maxi 440 and 760 lightning current arresters. Their capability of considerably limiting mains follow currents and extinguishing them within a few milliseconds makes these devices special.

The patented RADAX Flow follow current limitation ensures that low-value fuses are not tripped by follow currents.

The capability to discharge lightning currents without destruction and to suppress mains follow currents without tripping upstream overcurrent protective devices ensures a high degree of availability in electrical installations.

The operating state/fault indicator of the coordinated lightning current arresters needs no power to operate and immediately shows the operating state of the devices. Apart from the standard visual indication with green and red indicator flags, DEHnbloc Maxi 1 ... FM features a three-pole remote signalling terminal. With its floating changeover contact, the remote signal can be used as a break or make contact according to the particular circuit concept.



Coordinated Lightning Current Arresters – Type 1

DEHNbloc Maxi 1 440 (FM)

Coordinated single-pole lightning current arrester for use in 400/690 V systems;
FM version with floating remote signalling contact.

Type DBM 1 ...	440	440 FM
Part No.	961 140	961 145
SPD according to EN 61643-11 / IEC 61643-11	type 1 / class I	type 1 / class I
Max. continuous operating voltage (a.c.) (U_c)	440 V	440 V
Lightning impulse current (10/350 μ s) (I_{imp})	35 kA	35 kA
Voltage protection level (U_p)	≤ 2.5 kV	≤ 2.5 kV
Max. backup fuse (L) up to $I_K = 50$ kA _{rms} ($t_a \leq 0.2$ s)	500 A gG	500 A gG
Max. backup fuse (L) up to $I_K = 50$ kA _{rms} ($t_a \leq 5$ s)	250 A gG	250 A gG
Approvals	UL, CSA	UL, CSA
Type of remote signalling contact	—	changeover contact



DEHNbloc Maxi 1 760 FM

Coordinated single-pole lightning current arrester for use in 690 V systems;
with remote signalling contact for monitoring device (floating changeover contact).

Type DBM 1 ...	760 FM
Part No.	961 175
SPD according to EN 61643-11 / IEC 61643-11	type 1 / class I
Max. continuous operating voltage (a.c.) (U_c)	760 V
Lightning impulse current (10/350 μ s) (I_{imp})	25 kA
Voltage protection level (U_p)	≤ 4 kV
Max. backup fuse (L) up to $I_K = 25$ kA _{rms} ($t_a \leq 5$ s)	250 A gG
Approvals	UL, CSA
Type of remote signalling contact	changeover contact



Lightning Current Arresters – Type 1

Accessories for DEHNbloc® Maxi 440 / 760

Earthing Clip for two-module Enclosures, single-phase, three-pole

Earthing clip for connecting the earth terminal of e.g. three SPDs with two-module enclosure to earth, with terminal.

Type	EB DG 1000 1 3
Part No.	900 411
Dimensions	34 x 112 x 28 mm
Terminal	up to 25 mm ²



Earthing Clip for two-module Enclosures, single-phase, four-pole

Earthing clip for connecting the earth terminal of e.g. four SPDs with two-module enclosure to earth, with terminal.

Type	EB 1 4 9
Part No.	900 417
Dimensions	34 x 148 x 28 mm
Terminal	up to 25 mm ²





DEHNbloc® Maxi S

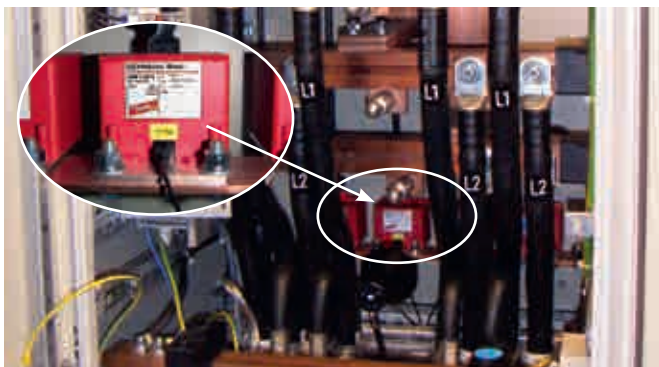

For protecting low voltage consumer's installations against surges and even direct lightning strikes. For installation in conformity with the lightning protection zone concept at the boundaries from $0_A - 1$.

- Spark-gap-based lightning current arrester with integrated lightning current carrying backup fuse in a compact enclosure
- Directly mounted on the PEN/N busbar
- Low voltage protection level $U_P \leq 2.5$ kV (including 80 cm connecting cable)
- Directly coordinated with DEHNguard surge protective device without additional cable length
- Short-circuit withstand capability of $100 \text{ kA}_{\text{rms}}$ ($220 \text{ kA}_{\text{peak}}$)
- High follow current extinguishing capability and limitation due to RADAX Flow technology
- High lightning current discharge capacity
- With optical-fibre interface for SPD monitoring

DEHNbloc Maxi 1 255 S: Coordinated lightning current arrester with integrated backup fuse for busbar installation

DEHNbloc Maxi S can be easily integrated into the application environment of a low-voltage switchgear installation or distribution board.

Thanks to its unique mechanical design, the coordinated DEHNbloc Maxi S lightning current arrester can be directly mounted on the PEN / N busbar of a switchgear installation without the need for additional adapters. With the backup fuse integrated in the device, no other separate backup fuses need to be installed.

Installing DEHNbloc Maxi S directly into the connection panel of a switchgear installation upstream of the circuit breaker ensures short cable lengths of the arresters and a low voltage protection level for the installation. In this environment, the VDE-tested DEHNbloc Maxi S can be used for short-circuit currents up to $100 \text{ kA}_{\text{rms}}$.

With a discharge capacity of 25 kA ($10/350 \mu\text{s}$), DEHNbloc Maxi S fulfils the highest national and international lightning protection standards for all three-phase current applications in TN and TT systems.

For 3+1 configurations, DEHNgap Maxi S provides a powerful creepage discharge spark gap with a discharge capacity of 100 kA ($10/350 \mu\text{s}$).

DEHNbloc Maxi S also features patented RADAX Flow follow current limitation, thus ensuring selectivity even in case of low-current-rated fuses.

The capability to conduct lightning impulse currents without destruction and to suppress mains follow currents without tripping upstream overcurrent protective devices ensures the availability of the switchgear installation in the event of a lightning strike. This considerably reduces the risk of arc formation in the installation.

In conjunction with the DEHNsignal remote signalling system, the operating state of DEHNbloc Maxi S devices can be monitored at any time.

Easy-to-implement optical transmission to the DEHNsignal E 3 remote signalling receiver module ensures safe electrical isolation between the power circuit and the remote signalling circuit.

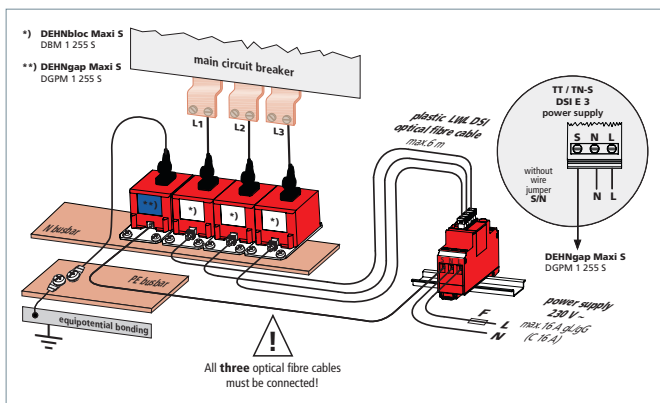

3+1 application in a TT / TN-S system

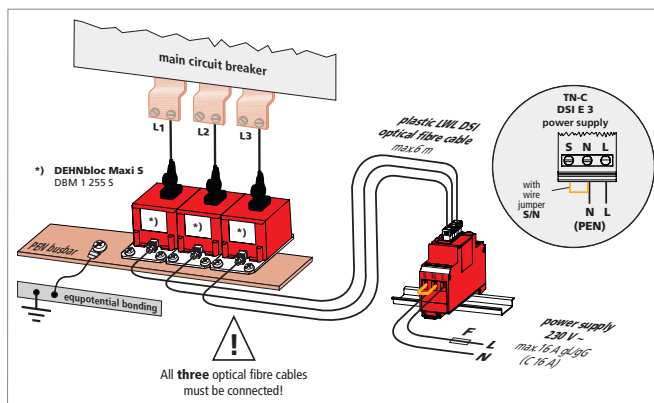

3-0 application in a TN-C system

DEHNbloc Maxi 1 255 S

Coordinated single-pole lightning current arrester with integrated backup fuse for busbar installation in 230/400 V systems.



Type	DBM 1 255 S
Part No.	900 220
SPD according to EN 61643-11 / IEC 61643-11	type 1 / class I
Max. continuous operating voltage (a.c.) (U_C)	255 V (50 / 60 Hz)
Lightning impulse current ($10/350 \mu\text{s}$) (I_{imp})	25 kA
Voltage protection level (U_P)	≤ 2.5 kV (including 80 cm connecting cable)
Max. mains-side overcurrent protection	not required
Operating state indication	by optical fibre cables via DSI E 3



DEHNsignal

- Operating state indication of the surge protective device connected
- Indication of phase failures
- Floating changeover contact
- Selective operating state indication
- Centralised fault indication

DEHNsignal E 3: Receiver module for optical transmission for selective operating state indication/centralised fault indication of three coordinated DEHNbloc Maxi S and, where appropriate, DEHNgap Maxi S lightning current arresters in five-wire systems

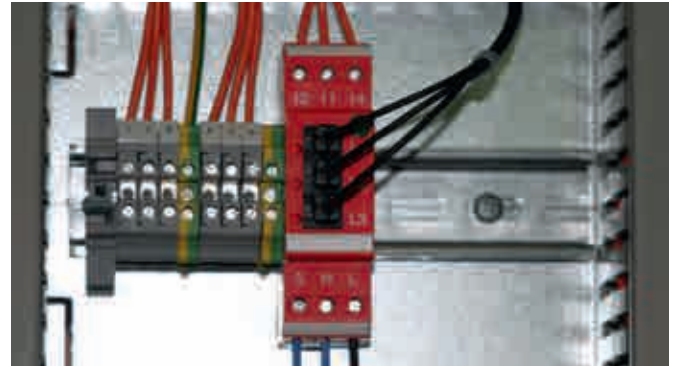

Receiver module for optical transmission with floating changeover contact for DEHNbloc Maxi S and DEHNgap Maxi S surge protective devices.



The DEHNsignal E 3 receiver module for optical transmission transmits remote signals of DEHNbloc Maxi S and DEHNgap Maxi S surge protective devices.

The DEHNsignal E 3 receiver module is particularly adapted to the place of installation of the coordinated DEHNbloc Maxi S and DEHNgap Maxi S surge protective devices.

Three DEHNbloc Maxi S arresters and, if necessary, the N-PE protective circuit can be remotely monitored by the receiver module via optical fibre cables.

Considering the special installation environment of surge protective devices in a switchgear installation, communication via optical fibre cable between the protective devices and the DEHNsignal E 3 receiver module is a considerable safety benefit.

The operating states of the individual arresters are transmitted to the DEHNsignal E 3 receiver module in the form of an optical signal via EMC-resistant plastic optical fibre cables. The optical signals are evaluated in the DEHNsignal E 3 receiver module and are converted into an electrical signal. The operating states can be directly read at the DEHNsignal E 3 receiver module or can be transmitted via a floating changeover contact. The DEHNsignal E 3 receiver module features a green indicator light to check its operating state. In addition to the operating state indication, the three red indicator lights of the selective operating state indication indicate the operating states of the assigned protective devices. The receiver module signals if a protective device of a phase fails. The surge protective devices and the DEHNsignal E 3 receiver module can be easily connected via optical fibre cable by means of the accessory parts described.



DEHNsignal E 3

Receiver module for optical transmission for selective operating state indication/centralised fault indication of three coordinated DEHNbloc Maxi S and, where appropriate, DEHNgap Maxi S lightning current arresters in five-wire systems.

Type	DSI E 3
Part No.	910 631
Supply voltage (a.c.) (U _N)	230 V
Power input (P)	< 550 mW
Backup fuse for supply voltage	16 A gG or C 16 A
Signal input	3x via optical fibre plug-in system (LWL ST DSI)
Type of remote signalling contact	floating changeover contact
Test standards	EN 61010-1:1993 and EN 61010-1/A2:1995



Accessories for DEHNsignal

LWL ST DSI

Plug for plastic optical fibre cables.

Type	LWL ST DSI
Part No.	910 641
Diameter	2.2 mm



LWL DSI 18M

18 metres of plastic optical fibre cable, preferably for use with DEHNbloc Maxi S.

Type	LWL DSI 18M
Part No.	910 642
Diameter	2.2 mm
Length	18 m



DEHNsecure modular



For protecting d.c. consumer's installations against surges and even direct lightning strikes. For installation in conformity with the lightning protection zone concept at the boundaries from $O_A - 1$.

- Coordinated spark-gap-based lightning current arrester consisting of a base part and a plug-in protection module
- Spark gap technology particularly suited for use in d.c. circuits
- High lightning current discharge capacity of 25 kA (10/350 μ s)
- Coordinated with DEHNguard SE DC ... surge protective devices
- Low voltage protection level
- Operating state / fault indication by green / red indicator flag in the inspection window
- Easy replacement of protection modules due to module locking system with module release button

- DEHNsecure M 1 ...: Coordinated and modular single-pole lightning current arrester for d.c. applications
- DEHNsecure M 1 ... FM: With remote signalling contact for monitoring device (floating changeover contact)
- DEHNsecure M 2P ...: Coordinated and modular two-pole lightning current arrester for d.c. applications
- DEHNsecure M 2P ... FM: With remote signalling contact for monitoring device (floating changeover contact)

The modular devices of the DEHNsecure product family are coordinated lightning current arresters with a functional design.

They can be energy-coordinated with type 2 surge arresters of the DEHNguard SE DC family (minimum decoupling length of 1 m must be observed).

The DEHNsecure arresters combine high performance and ease of use in a single device. Their electrical parameters are rated for the most stringent requirements in lightning and surge protection systems.

The internal structure of the DEHNsecure spark gap is suited for use in d.c. circuits. The device concept prevents mains follow currents up to 25,000 A d.c. from occurring.

With this new arrester series, a consistent lightning protection zone concept including the cross-boundary d.c. lines can now be implemented.

Furthermore, the leakage-current-free version of the spark-gap-based arrester offers numerous advantages when used in insulation monitored systems or for applications with extreme requirements on the self-energy consumption.

DEHNsecure arresters are used, for example, in safety lighting systems, emergency power supplies, d.c. systems for direct supply of d.c. drives, control circuits and any kind of battery-operated power supply.

DEHNsecure M 1 60 (FM) and **DEHNsecure M 2P 60 (FM)** are specifically developed for Remote Radio Head (RRH) applications. Designed for possible high load currents, they leave sufficient margin for future extensions in the field of mobile communication.

DEHNsecure M 1 242 (FM) is used for safety lighting systems. The relevant loads are supplied with a.c. voltage during normal operation and with battery-operated d.c. voltage during emergency operation. As surges may occur during both operating states, DEHNsecure M 1 242 is suited for direct and alternating currents (backup fuse max. 10 A gG).

The modular design of the DEHNsecure arresters makes them safe and user-friendly. Their vibration-proof module locking system, for example, is said to be unique. Shock or vibration during transport or operation or enormous mechanical impulse loads resulting from discharges do not affect the module locking system which ensures safe fixation both for the base part and protection module. Nevertheless, the protection modules can be easily replaced without tools by simply pressing the easy-to-use module release button. The mechanically coded base part and protection module prohibit installing an incorrect module. DEHNsecure arresters incorporate double terminals, allowing series connection of the arresters in a space-saving and cost-effective way according to IEC 60364-5-53 requirements for nominal currents up to 125 A.

The operating state / fault indicator of DEHNsecure needs no power to operate and instantly shows the operating state of the device. Apart from the standard visual indicator with red and green indicator flags, DEHNsecure ... FM devices have an additional remote signalling output. With its floating changeover contact, the remote signal can be used as a break or make contact according to the particular circuit concept.

DEHNsecure M 1 ...

Coordinated and modular single-pole lightning current arrester for d.c. applications.



Type DSE M ...	1 60	1 220	1 242
Part No.	971 121	971 120	971 122
SPD classification according to EN 61643-11 / IEC 61643-11	type 1 / class I	type 1 / class I	type 1 / class I
Max. continuous operating voltage (d.c.) (U_C)	60 V	220 V	242 V
Lightning impulse current (10/350 μ s) (I_{imp})	25 kA	25 kA	25 kA
Voltage protection level (U_P)	≤ 1.5 kV	≤ 2.5 kV	≤ 2.5 kV
Max. mains-side overcurrent protection	250 A gL	250 A gL	250 A gL
Approvals	UL	—	—
Extended technical data:	when used in safety lighting systems		
– Max. continuous operating voltage (a.c.) (U_C)	—	—	255 V

DEHNsecure M 1 ... FM

Coordinated and modular single-pole lightning current arrester for d.c. applications; with remote signalling contact for monitoring device (floating changeover contact).

Type DSE M ...	1 60 FM	1 220 FM	1 242 FM
Part No.	971 126	971 125	971 127
SPD classification according to EN 61643-11 / IEC 61643-11	type 1 / class I	type 1 / class I	type 1 / class I
Max. continuous operating voltage (d.c.) (U_c)	60 V	220 V	242 V
Lightning impulse current (10/350 μ s) (I_{imp})	25 kA	25 kA	25 kA
Voltage protection level (U_p)	≤ 1.5 kV	≤ 2.5 kV	≤ 2.5 kV
Max. mains-side overcurrent protection	250 A gL	250 A gL	250 A gL
Approvals	UL	—	—
Type of remote signalling contact	changeover contact	changeover contact	changeover contact
Extended technical data:	when used in safety lighting systems		
– Max. continuous operating voltage (a.c.) (U_c)	—	—	255 V



DEHNsecure M 2P ... (FM)

Coordinated and modular two-pole lightning current arrester for d.c. applications up to 60 V (1+1 configuration); FM version with floating remote signalling contact.

Type DSE M ...	2P 60	2P 60 FM
Part No.	971 221	971 226
SPD classification according to EN 61643-11 / IEC 61643-11	type 1 / class I	type 1 / class I
Max. continuous operating voltage (d.c.) (U_c)	60 V	60 V
Lightning impulse current (10/350 μ s) (DC+/DC- -> DC-/DC+) / (DC-/DC+ -> \oplus) (I_{imp})	25 / 50 kA	25 / 50 kA
Voltage protection level (DC+/DC- -> DC-/DC+) / (DC-/DC+ -> \oplus) (U_p)	≤ 1.5 / ≤ 1.5 kV	≤ 1.5 / ≤ 1.5 kV
Max. mains-side overcurrent protection	250 A gL	250 A gL
Approvals	UL	UL
Type of remote signalling contact	—	changeover contact



Protection Module for DEHNsecure modular

- Spark gap technology particularly suited for use in d.c. circuits
- Operating state / fault indication by green/red indicator flag in the inspection window
- Easy replacement of protection modules without tools due to module locking system with module release button



DSE MOD ...: Spark-gap-based protection module

Avoid additional, short-notice and unplanned maintenance jobs. In multipole protective circuits, we recommend replacing the complete set of protection modules when one module fails.

For protecting d.c. consumer's installations against surges and even direct lightning strikes. For installation in conformity with the lightning protection zone concept at the boundaries from $0_A - 1$.

DSE M Spark-Gap-Based Protection Module

Spark-gap-based protection module

Type DSE MOD ...	60	220	242
Part No.	971 001	971 002	971 003
Max. continuous operating voltage (d.c.) (U_c)	60 V	220 V	242 V
Lightning impulse current (10/350 μ s) (I_{imp})	25 kA	25 kA	25 kA



DSE PE Spark-Gap-Based Protection Module

Spark-gap-based protection module

Type DSE MOD ...	PE 60
Part No.	971 010
Max. continuous operating voltage (d.c.) (U_c)	60 V
Lightning impulse current (10/350 μ s) (I_{imp})	50 kA





For protecting low-voltage consumer's installations against surges and even direct lightning strikes. For installation in conformity with the lightning protection zone concept at the boundaries from $0_A - 1$.

- Encapsulated creepage discharge spark gap without venting means
- RADAX Flow spark gap technology with high follow current limitation
- Energy coordination with other arresters of the Red/Line product family
- Can also be used upstream of meter panels due to its high insulation resistance
- Multifunctional terminal for connecting conductors and busbars
- Single-pole and three-pole version (lightning impulse currents up to 100 kA depending on the system configuration)
- Modular single-pole version also available

DEHNbloc H M 1 255: Modular single-pole lightning current arrester with high follow current limitation

DEHNbloc 1 255 H: Single-pole lightning current arrester with high follow current limitation

DEHNbloc 3 255 H: Three-pole lightning current arrester with high follow current limitation

The spark gaps of the DEHNbloc lightning current arresters allow compact configuration of low-voltage distribution boards. By using pressurised and encapsulated creepage discharge spark gaps, no safety distance from busbars and special flameproof enclosures are necessary.

With a lightning current discharge capacity up to 50 kA (10/350 μ s) per pole, DEHNbloc devices fulfil the highest national and international lightning protection and application standards.

The consistent improvement of the integration concept made the DEHNbloc devices even more efficient: With DEHNbloc H, the ground-breaking RADAX Flow spark gap technology for follow current extinction and limitation was integrated into the DEHNbloc family.

The RADAX Flow technology prevents that system operation is disrupted due to a tripped circuit breaker as soon as the arrester operates. In times where systems increasingly depend on a properly functioning electrical infrastructure, this is an indispensable product feature. Thanks to the patented RADAX Flow principle, even the amplitude of short-circuit currents in installations up to 50 kA_{rms} can be limited to approx. 500 A and extinguished after approximately 5 ms. This feature ensures selectivity even in case of low-current-rated fuses.

But the DEHNbloc H family concept also stands out due to other product features: With its double terminals on the phase and earth side, the single-pole DEHNbloc 1 255 H device offers various application options.

The DBH M 1 255 device with a new arrester design features the approved module release system that safely fixes the protection module to the base part even at maximum loads on the protection module. The module can be easily replaced without tools by simply pressing the module release button of the protection module.

By using the double terminals suitable for all conductors, even three-pole DEHNbloc 3 255 H arresters can be connected in series in a space-saving and cost-effective way up to nominal currents of 125 A as preferred by IEC 60364-5-53.

If DEHNbloc is to be used with other DIN rail mounted devices, the multifunctional terminals are ideally suited for providing connection for conductors and busbars.

DEHNbloc H

Modular single-pole lightning current arrester with a high discharge capacity for use in 230/400 V systems.



Type	DBH M 1 255
Part No.	961 122
SPD according to EN 61643-11 / IEC 61643-11	type 1 / class I
Max. continuous operating voltage (a.c.) (U_c)	255 V (50 / 60 Hz)
Lightning impulse current (10/350 μ s) (I_{imp})	50 kA
Voltage protection level (U_p)	≤ 4 kV
Max. backup fuse (L) up to $I_k = 50$ kA _{rms} ($t_a \leq 0.2$ s)	500 A gG
Max. backup fuse (L) up to $I_k = 50$ kA _{rms} ($t_a \leq 5$ s)	315 A gG

Accessories for DEHNbloc®

DB H Spark-Gap-Based Protection Module

Spark-gap-based protection module



Type	DBH MOD 255
Part No.	961 022
Max. continuous operating voltage (a.c.) (U_c)	255 V

DEHNbloc 1 255 H

Single-pole (3-0 configuration) lightning current arrester with a high discharge capacity for use in 230/400 V systems.

Type	DB 1 255 H
Part No.	900 222
SPD according to EN 61643-11 / IEC 61643-11	type 1 / class I
Max. continuous operating voltage (a.c.) (U_c)	255 V (50 / 60 Hz)
Lightning impulse current (10/350 μ s) (I_{imp})	50 kA
Voltage protection level (U_p)	≤ 4 kV
Max. backup fuse up to $I_K = 50$ kA _{rms} ($t_a \leq 0.2$ s)	500 A gG
Max. backup fuse up to $I_K = 50$ kA _{rms} ($t_a \leq 5$ s)	315 A gG
Approvals	KEMA



DEHNbloc 3 255 H

Three-pole (3-0 configuration) lightning current arrester with a high discharge capacity for use in 230/400 V systems.

Type	DB 3 255 H
Part No.	900 120
SPD according to EN 61643-11 / IEC 61643-11	type 1 / class I
Max. continuous operating voltage (a.c.) (U_c)	255 V (50 / 60 Hz)
Lightning impulse current (10/350 μ s) [L1+L2+L3-N/PEN] (I_{total})	100 kA
Voltage protection level (U_p)	≤ 4 kV
Max. backup fuse up to $I_K = 50$ kA _{rms} ($t_a \leq 0.2$ s)	500 A gG
Max. backup fuse up to $I_K = 50$ kA _{rms} ($t_a \leq 5$ s)	315 A gG
Approvals	KEMA



DEHN protects.®



DEHNrall

DR MOD 255

green: ok → red: ✘

No. 953 010

U_c 255 V (50/60 Hz)

I_n 3 kA

U_{oc} 6 kV

U_p 1,25 kV (L-N)

U_p 1,5 kV (L/N-PE)

I_{total} 5 kA

T3

DEHNgap

- Discharge capacity up to 100 kA (10/350 μ s)
- Total current arrester specifically designed for installation in 3+1 and 1+1 configurations of TT systems according to IEC 60364-5-53 between neutral conductor N and protective conductor PE
- Creepage discharge spark gap technology
- Operating state / fault indication by green / red indicator flag in the inspection window



For protecting low-voltage consumer's installations against surges and even direct lightning strikes. For installation in conformity with the lightning protection zone concept at the boundaries from $0_A - 1$ ("3+1" configuration).

- DEHNgap M 255 (FM):** Coordinated and modular single-pole N-PE lightning current arrester
- DEHNgap Maxi 1 255 S:** Coordinated single-pole N-PE lightning current arrester for busbars
- DEHNgap Maxi 1 255 (FM):** Coordinated single-pole N-PE lightning current arrester for 3+1 configurations with DEHNvenCI
- DEHNgap Maxi 440 (FM):** Coordinated single-pole N-PE lightning current arrester for $U_c = 440$ V a.c.
- DEHNgap H M 255:** Modular single-pole N-PE lightning current arrester

Being total current arresters between the neutral and protective conductor in TT systems, the single-pole N-PE lightning current arresters of type DEHNgap M, DEHNgap Maxi, DEHNgap Maxi S and DEHNgap H M help to ensure fulfilling the requirements for protecting personnel and equipment in "1+1" or "3+1" configurations. The creepage discharge spark gaps were specifically developed to meet this challenge. With a discharge capacity up to 100 kA (10/350 μ s), they fulfil the highest national and international lightning protection standards. Their leakage-current-free spark gap design allows the devices to be used in areas upstream of the meter panel according to the German VDN guideline.

The DEHNgap M, DEHNgap Maxi S and DEHNgap Maxi coordinated N-PE lightning current arresters hold a special position among total current arresters. Due to their low voltage protection level, they can be directly coordinated with N-PE surge arresters of the DEHNguard M family and DEHNgap C S surge arresters without additional decoupling coil. If lightning current arresters are to be installed along with surge arresters at the same location, no additional DEHNgap C S is required thanks to the low voltage protection level of DEHNgap M and DEHNgap Maxi.

The design and installation of DEHNgap Maxi S arresters are adapted to the unique nature of low-voltage switchgear installations and entirely complement the use of DEHNbloc Maxi S arresters.

The multifunctional terminals of the DIN rail mounted DEHNgap M and DEHNgap H M devices are suitable for connecting conductors and busbars, allowing comfortable wiring with other DIN rail mounted terminals.

With its functional Red/Line design, DEHNgap M combines safety and ease of use in a single device. The mechanical operating state / fault indication as well as the unique module locking system stand for fulfilling high safety requirements. The module locking system fixes the protection modules to the base part. Neither vibration during transport nor the enormous electromagnetic forces of discharge can loosen the protection modules. Nevertheless, they can be easily replaced without tools by simply pressing the easy-to-use module release button of the protection module. Each protection module is mechanically coded to ensure against installing an incorrect module. Apart from the standard visual indication of DEHNgap M, DEHNgap M ... FM features a three-pole remote signalling terminal. With its floating changeover contact, the remote signal can be used as a break or make contact according to the particular circuit concept.



DEHNgap M 255 (FM)

Coordinated and modular single-pole N-PE lightning current arrester; FM version with floating remote signalling contact.



Type	DGP M 255	DGP M 255 FM
Part No.	961 101	961 105
SPD according to EN 61643-11 / IEC 61643-11	type 1 / class I	type 1 / class I
Max. continuous operating voltage (a.c.) (U_c)	255 V (50 / 60 Hz)	255 V (50 / 60 Hz)
Lightning impulse current (10/350 μ s) (I_{imp})	100 kA	100 kA
Voltage protection level (U_p)	≤ 1.5 kV	≤ 1.5 kV
Approvals	VDE, KEMA, UL	VDE, KEMA, UL
Type of remote signalling contact	—	changeover contact

DEHNgap Maxi 1 255 S

Coordinated single-pole N-PE lightning current arrester for busbars.



Type	DGPM 1 255 S
Part No.	900 050
SPD according to EN 61643-11 / IEC 61643-11	type 1 / class I
Max. continuous operating voltage (a.c.) (U_c)	255 V (50 / 60 Hz)
Lightning impulse current (10/350 μ s) (I_{imp})	100 kA
Voltage protection level (U_p)	≤ 2.5 kV (80 cm connecting cable included)
Operating state monitoring	via DEHNSignal DSI E 3

DEHNgap Maxi 1 255 (FM)

Coordinated single-pole N-PE lightning current arrester; FM version with floating remote signalling contact.



Type	DGPM 1 255	DGPM 1 255 FM
Part No.	961 180	961 185
SPD according to EN 61643-11 / IEC 61643-11	type 1 / class I	type 1 / class I
Max. continuous operating voltage (a.c.) (U_c)	255 V (50 / 60 Hz)	255 V (50 / 60 Hz)
Lightning impulse current (10/350 μ s) (I_{imp})	100 kA	100 kA
Voltage protection level (U_p)	≤ 1.5 kV	≤ 1.5 kV
Type of remote signalling contact	—	changeover contact

DEHNgap Maxi 440 (FM)

Coordinated single-pole N-PE lightning current arrester; FM version with floating remote signalling contact.



Type	DGPM 440	DGPM 440 FM
Part No.	961 160	961 165
SPD according to EN 61643-11 / IEC 61643-11	type 1 / class I	type 1 / class I
Max. continuous operating voltage (a.c.) (U_c)	440 V (50 / 60 Hz)	440 V (50 / 60 Hz)
Lightning impulse current (10/350 μ s) (I_{imp})	100 kA	100 kA
Voltage protection level (U_p)	≤ 2.5 kV	≤ 2.5 kV
Approvals	UL	UL
Type of remote signalling contact	—	changeover contact

DEHNgap H M 255

Modular single-pole N-PE lightning current arrester.



Type	DGPH M 255
Part No.	961 102
SPD according to EN 61643-11 / IEC 61643-11	type 1 / class I
Max. continuous operating voltage (a.c.) (U_c)	255 V (50 / 60 Hz)
Lightning impulse current (10/350 μ s) (I_{imp})	100 kA
Voltage protection level (U_p)	≤ 4 kV

Protection Module for DEHNgap modular

- High discharge capacity due to powerful creepage discharge spark gap
- Easy replacement of protection modules without tools due to module locking system with module release button
- Operating state / fault indication by green / red indicator flag in the inspection window
- The plug-in protection module can be replaced without the need to de-energise and without removing the distribution board cover



For protecting low-voltage consumer's installations against surges and even direct lightning strikes. For installation in conformity with the lightning protection zone concept at the boundaries from $0_A - 1$ (3+1 configuration).

DGP M MOD 255: 100 kA N-PE spark-gap-based protection module for all devices of the modular DEHNgap M family

DGPH MOD 255: 100 kA N-PE spark-gap-based protection module for all devices of the modular DEHNgap M H family

The N-PE spark-gap-based protection modules of the modular DEHNgap M family combine safety and innovation in a single device. Apart from the powerful encapsulated creepage discharge spark gap, the compact protection modules incorporate a monitoring device and an operating state / fault indicator. The mechanical coding of the protection module prevents

that the N-PE protection modules are confused with the spark-gap-based protection module for the phase conductors. The module locking system safely fixes the protection modules to the base part. The protection modules can be easily removed without tools by simply pressing the release button.

DGP M – 100 kA N-PE Spark-Gap-Based Protection Module

N-PE spark-gap-based protection module for all devices of the modular DEHNgap M family.

Type	DGP M MOD 255
Part No.	961 010
Max. continuous operating voltage (a.c.) (U_c)	255 V
Lightning impulse current (10/350 μ s) (I_{imp})	100 kA



DGPH M – 100 kA N-PE Spark-Gap-Based Protection Module

N-PE spark-gap-based protection module for all devices of the modular DEHNgap H M family.



Type	DGPH MOD 255
Part No.	961 020
Max. continuous operating voltage (a.c.) (U_c)	255 V
Lightning impulse current (10/350 μ s) (I_{imp})	100 kA



Selection Chart – Industrial Buildings

TN-C system	TN-S system	TT system	230/400 V a.c.	400/690 V a.c.	Higher voltages (a.c.)	Integrated backup fuse	DIIN rail	d.c. applications	PV system	Remote signalling Contact (FIV)	Type	Part No.	Page
1 pc			•			•	•				DG M TNC CI 275	952 304	57
1 pc			•			•	•			•	DG M TNC CI 275 FM	952 309	57
	1 pc		•			•	•				DG M TNS CI 275	952 401	57
	1 pc		•			•	•			•	DG M TNS CI 275 FM	952 406	57
		1 pc	•			•	•				DG M TT CI 275	952 322	57
		1 pc	•			•	•			•	DG M TT CI 275 FM	952 327	57
1 pc			•				•				DG M TNC 275	952 300	62
1 pc			•				•			•	DG M TNC 275 FM	952 305	62
	1 pc		•				•				DG M TNS 275	952 400	62
	1 pc		•				•			•	DG M TNS 275 FM	952 405	62
		1 pc	•				•				DG M H TT 275	952 381	63
		1 pc	•				•			•	DG M H TT 275 FM	952 385	63
3 pcs	4 pcs	3 pcs	•			•	•				DG S CI 275	952 079	58
3 pcs	4 pcs	3 pcs	•				•				DG S 275	952 070	68
		1 pc	•				•				DGP C S	952 030	83
3 pcs	4 pcs	3 pcs	•			•	•			•	DG S CI 275 FM	952 099	58
3 pcs	4 pcs	3 pcs	•				•			•	DG S 275 FM	952 090	69
		1 pc	•				•			•	DGP C S FM	952 035	83
1 pc				•			•				DG M TNC 440	952 303	62
1 pc				•			•			•	DG M TNC 440 FM	952 308	62
1 pc				•		•	•			•	DG SE CI 440 FM	952 920	60
1 pc				•		•	•			•	DG SE CI WE 440 FM	952 923	60
3 pcs	4 pcs				•		•				DG S WE 600	952 077	69
3 pcs	4 pcs				•		•			•	DG S WE 600 FM	952 097	69
1 pc					•		•				DG M WE 600	952 302	65
1 pc					•		•			•	DG M WE 600 FM	952 307	65
3 pcs	4 pcs				•		•			•	DG SE H 1000 FM	952 938	72
3 pcs	4 pcs				•		•			•	DG SE H 1000 VA FM	952 940	72
3 pcs	4 pcs	3 pcs	•				•			•	DG SE H LI 275 FM	952 930	72
		1 pc	•				•			•	DGP C S FM	952 035	83
							•	•			DG SE DC 242	972 120	85
							•	•		•	DG SE DC 242 FM	972 125	85
							•	•	•		DG M YPV SCI 1000	952 510	88
							•	•	•	•	DG M YPV SCI 1000 FM	952 515	88
								•			DCU YPV SCI 1000 1M	900 910	93

Selection Chart – Office and Administration Buildings

TIN-C system	TIN-S system	TT system	Integrated backup fuse 	DIN rail	Single-phase application	d.c. application 	Remote signaling contact (FM)	Type	Part No.	Page
1 pc			•	•				DG M TNC CI 275	952 304	57
1 pc			•	•			•	DG M TNC CI 275 FM	952 309	57
	1 pc		•	•				DG M TNS CI 275	952 401	57
	1 pc		•	•			•	DG M TNS CI 275 FM	952 406	57
		1 pc	•	•				DG M TT CI 275	952 322	57
		1 pc	•	•			•	DG M TT CI 275 FM	952 327	57
3 pcs	4 pcs	3 pcs	•	•				DG S CI 275	952 079	58
		1 pc		•				DGP C S	952 030	83
3 pcs	4 pcs	3 pcs	•	•			•	DG S CI 275 FM	952 099	58
		1 pc		•			•	DGP C S FM	952 035	83
1 pc				•				DG M TNC 275	952 300	62
1 pc				•			•	DG M TNC 275 FM	952 305	62
	1 pc			•				DG M TNS 275	952 400	62
	1 pc			•			•	DG M TNS 275 FM	952 405	62
		1 pc		•			•	DG M H TT 275	952 381	63
		1 pc		•			•	DG M H TT 275 FM	952 385	63
3 pcs	4 pcs	3 pcs		•				DG S 275	952 070	68
		1 pc		•				DGP C S	952 030	83
3 pcs	4 pcs	3 pcs		•			•	DG S 275 FM	952 090	69
3 pcs	4 pcs	3 pcs		•			•	DG SE H LI 275 FM	952 930	72
		1 pc		•			•	DGP C S FM	952 035	83
					•			DCOR L 3P 275 SO LTG	900 445	81
					•			DCOR L 3P 275 SO IP	900 447	82
				•		•		DG SE DC 242	972 120	85
				•		•	•	DG SE DC 242 FM	972 125	85

Selection Chart – Residential Buildings

TIN-C system	TIN-S system	TT system	DIN rail	PV system 	Remote signaling contact (FM)	Type	Part No.	Page
1 pc			•			DG M TNC 275	952 300	62
1 pc			•		•	DG M TNC 275 FM	952 305	62
	1 pc		•			DG M TNS 275	952 400	62
	1 pc		•		•	DG M TNS 275 FM	952 405	62
		1 pc	•			DG M TT 275	952 310	63
		1 pc	•		•	DG M TT 275 FM	952 315	63
		1 pc	•		•	DG M H TT 275	952 381	63
		1 pc	•		•	DG M H TT 275 FM	952 385	63
3 pcs	4 pcs	3 pcs	•			DG S 275	952 070	68
		1 pc	•			DGP C S	952 030	83
3 pcs	4 pcs	3 pcs	•		•	DG S 275 FM	952 090	69
		1 pc	•		•	DGP C S FM	952 035	83
				•		DCU YPV SCI 1000 1M	900 910	93
			•	•		DG YPV SCI 1000	950 530	92
			•	•	•	DG YPV SCI 1000 FM	950 535	92

DEHNguard® modular with integrated Backup Fuse

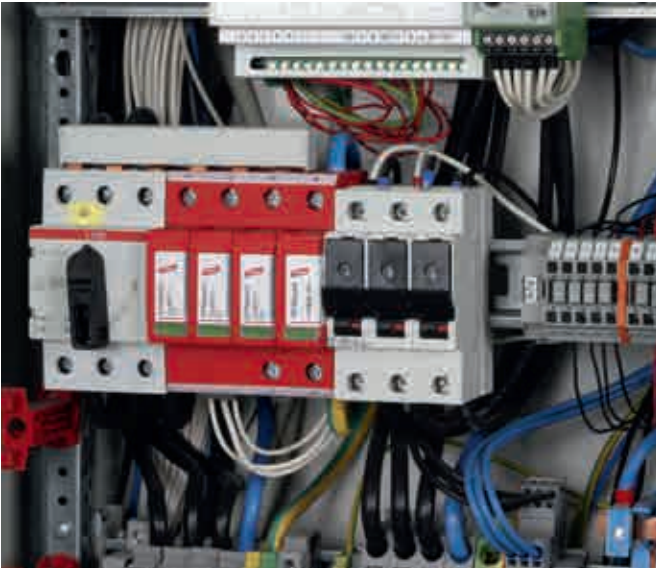

For protecting low-voltage consumer's installations against surges. For installation in conformity with the lightning protection zone concept at the boundaries from $O_B - 1$ and higher.

- DEHNguard M TNC CI 275:** Modular surge arrester with integrated backup fuse for TN-C systems
- DEHNguard M TNS CI 275:** With integrated backup fuse for TN-S systems
- DEHNguard M TT CI 275:** With integrated backup fuse for TT and TN-S systems (3+1 configuration)
- DEHNguard M TN CI 275:** With integrated backup fuse for 230 V TN systems
- DEHNguard M TT 2P CI 275:** With integrated backup fuse for 230 V TT and TN systems (1+1 configuration)
- DEHNguard S CI 275:** Modular single-pole surge arrester with integrated backup fuse
- DEHNguard M ... CI 275 FM:** With remote signalling contact for monitoring device (floating changeover contact)

Featuring the functional Red/Line design, the modular surge arresters of the DEHNguard ... CI family combine short-circuit and surge protection in a single protection module with a width of only one module, setting new patterns for ease of application.

The protective circuit has the arrester backup fuse integrated in the protection module. This feature together with the heavy-duty zinc oxide varistor and the dual "Thermo Dynamic Control" monitoring device allow easy installation with minimum space requirements.

With the already integrated arrester backup fuse, the user no longer has to care about arrester-specific dimensioning requirements such as backup protection in the event of a short-circuit and impulse current carrying capability.

The integrated fuse has been developed especially for this case of application. It is not designed for permanent current but especially for impulse current and short-circuit protection thus, an optimal performance is ensured. The fuse never must be replaced separately because tripping of fuse is also end of SPD service life. Space-saving surge protection measures covering all functions specified in the installation standards can be implemented in installations with short-circuit currents up to 25 kA_{rms}. All paths including the N-PE path feature an operating state indicator as required by the IEC 60364-5-53 standard.

Due to the "Thermo Dynamic Control" monitoring device, the surface temperature of the heavy-duty varistor and the intensity of the discharge current are used for evaluation. The operating state of each protective path is shown by means of a mechanical indicator with green and red

- Arrester backup fuse integrated in the protection module
- Prewired complete unit consisting of a base part and plug-in protection modules
- Energy coordination with other arresters of the Red/Line product family
- High discharge capacity
- High reliability due to "Thermo Dynamic Control" SPD monitoring device
- Easy replacement of protection modules without tools due to module locking system with module release button

indicator flags which needs no power to operate. It also indicates the activation of the "Thermo Dynamic Control" monitoring device and the integrated arrester backup fuse.

In addition to this mechanical operating state/fault indication, the ... FM version of the DEHNguard ... CI devices features a three-pole remote signalling terminal. With its floating changeover contact, the remote signal can be used as break or make contact according to the particular circuit concept.

All the benefits of the modular design of the DEHNguard family have been integrated into the new DEHNguard ... CI family.

The system-configuration-specific product designation and the "Thermo Dynamic Control" monitoring device reflect the high safety requirements.

The unique module locking system prevents the protection modules from becoming loose due to vibration during transport or the enormous forces of discharge. Nevertheless, the protection modules can be easily replaced without tools, the need to de-energise and removing the distribution board cover by simply pressing the easy-to use module release button of the protection modules. Each protective circuit in the multipole and single-pole arresters and each protection module is mechanically coded to ensure against installing an incorrect protection module.

The surge arresters of the modular DEHNguard ... CI family feature multi-functional terminals on a standardised spacing of one module for connecting conductors and busbars, allowing easy wiring with other DIN rail mounted devices. Thus, a variety of applications can be easily connected in series in accordance with IEC 60364-5-53 for optimal protection.

DEHNgard M TNC CI ... (FM)

Modular surge arrester with integrated backup fuses for TN-C systems with a nominal voltage of 230/400 V (3+0 configuration); FM version with floating remote signalling contact.

Type DG ...	M TNC CI 275	M TNC CI 275 FM
Part No.	952 304	952 309
SPD according to EN 61643-11 / IEC 61643-11	type 2 / class II	type 2 / class II
Max. continuous operating voltage (a.c.) (U_c)	275 V (50 / 60 Hz)	275 V (50 / 60 Hz)
Nominal discharge current (8/20 μ s) (I_n)	12.5 kA	12.5 kA
Max. discharge current (8/20 μ s) (I_{max})	25 kA	25 kA
Voltage protection level (U_p)	≤ 1.5 kV	≤ 1.5 kV
Max. mains-side overcurrent protection	not required	not required
Approvals	KEMA, VDE	KEMA, VDE
Type of remote signalling contact	—	changeover contact



DEHNgard M TNS CI ... (FM)

Modular surge arrester with integrated backup fuses for TN-S systems with a nominal voltage of 230/400 V (4+0 configuration); FM version with floating remote signalling contact.

Type DG ...	M TNS CI 275	M TNS CI 275 FM
Part No.	952 401	952 406
SPD according to EN 61643-11 / IEC 61643-11	type 2 / class II	type 2 / class II
Max. continuous operating voltage (a.c.) (U_c)	275 V (50 / 60 Hz)	275 V (50 / 60 Hz)
Nominal discharge current (8/20 μ s) (I_n)	12.5 kA	12.5 kA
Max. discharge current (8/20 μ s) (I_{max})	25 kA	25 kA
Voltage protection level [L-PE] / [N-PE] (U_p)	$\leq 1.5 / \leq 1.5$ kV	$\leq 1.5 / \leq 1.5$ kV
Max. mains-side overcurrent protection	not required	not required
Approvals	KEMA, VDE	KEMA, VDE
Type of remote signalling contact	—	changeover contact



DEHNgard M TT CI ... (FM)

Modular surge arrester with integrated backup fuses for TT and TN-S systems with a nominal voltage of 230/400 V (3+1 configuration); FM version with floating remote signalling contact.

Type DG ...	M TT CI 275	M TT CI 275 FM
Part No.	952 322	952 327
SPD according to EN 61643-11 / IEC 61643-11	type 2 / class II	type 2 / class II
Max. continuous operating voltage (a.c.) [L-N] (U_c)	275 V (50 / 60 Hz)	275 V (50 / 60 Hz)
Nominal discharge current (8/20 μ s) [L-N] (I_n)	12.5 kA	12.5 kA
Max. discharge current (8/20 μ s) [L-N] (I_{max})	25 kA	25 kA
Voltage protection level [L-N] / [N-PE] (U_p)	$\leq 1.5 / \leq 1.5$ kV	$\leq 1.5 / \leq 1.5$ kV
Max. mains-side overcurrent protection	not required	not required
Approvals	KEMA, VDE	KEMA, VDE
Type of remote signalling contact	—	changeover contact



DEHNgard M TN CI ... (FM)

Modular surge arrester with integrated backup fuses for single-phase 230 V TN systems (2+0 configuration); FM version with floating remote signalling contact.

Type DG ...	M TN CI 275	M TN CI 275 FM
Part No.	952 173	952 178
SPD according to EN 61643-11 / IEC 61643-11	type 2 / class II	type 2 / class II
Max. continuous operating voltage (a.c.) (U_c)	275 V (50 / 60 Hz)	275 V (50 / 60 Hz)
Nominal discharge current (8/20 μ s) (I_n)	12.5 kA	12.5 kA
Max. discharge current (8/20 μ s) (I_{max})	25 kA	25 kA
Voltage protection level [L-PE] / [N-PE] (U_p)	$\leq 1.5 / \leq 1.5$ kV	$\leq 1.5 / \leq 1.5$ kV
Max. mains-side overcurrent protection	not required	not required
Approvals	KEMA, VDE	KEMA, VDE
Type of remote signalling contact	—	changeover contact



**DEHNgard M TT 2P CI ... (FM)**

Modular surge arrester with integrated backup fuses for single-phase 230 V TT and TN systems (1+1 configuration); FM version with floating remote signalling contact.

Type DG ...	M TT 2P CI 275	M TT 2P CI 275 FM
Part No.	952 171	952 176
SPD according to EN 61643-11 / IEC 61643-11	type 2 / class II	type 2 / class II
Max. continuous operating voltage (a.c.) [L-N] (U_c)	275 V (50 / 60 Hz)	275 V (50 / 60 Hz)
Nominal discharge current (8/20 μ s) [L-N] (I_n)	12.5 kA	12.5 kA
Max. discharge current (8/20 μ s) [L-N] (I_{max})	25 kA	25 kA
Voltage protection level [L-N] / [N-PE] (U_p)	$\leq 1.5 / \leq 1.5$ kV	$\leq 1.5 / \leq 1.5$ kV
Max. mains-side overcurrent protection	not required	not required
Approvals	KEMA, VDE	KEMA, VDE
Type of remote signalling contact	—	changeover contact

DEHNgard S CI ... (FM)

Pluggable single-pole surge arrester consisting of a base part and plug-in protection module; with integrated backup fuse; FM version with floating remote signalling contact.

Type DG ...	S CI 275	S CI 275 FM
Part No.	952 079	952 099
SPD according to EN 61643-11 / IEC 61643-11	type 2 / class II	type 2 / class II
Max. continuous operating voltage (a.c.) (U_c)	275 V (50 / 60 Hz)	275 V (50 / 60 Hz)
Nominal discharge current (8/20 μ s) (I_n)	12.5 kA	12.5 kA
Max. discharge current (8/20 μ s) (I_{max})	25 kA	25 kA
Voltage protection level (U_p)	≤ 1.5 kV	≤ 1.5 kV
Max. mains-side overcurrent protection	not required	not required
Approvals	KEMA, VDE	KEMA, VDE
Type of remote signalling contact	—	changeover contact

**Accessories for DEHNgard® modular with integrated Backup Fuse****Varistor-Based Protection Module for DEHNgard M CI**

Protection module for DEHNgard M ... CI 275 surge arresters comprising a varistor connected in series with the integrated backup fuse.

Type	DG MOD CI 275
Part No.	952 020
Max. continuous operating voltage (a.c.) (U_c)	275 V

Varistor-Based Protection Module

Varistor-based protection module for DEHNgard M ... and DEHNgard S ... surge arresters.

Type	DG MOD 275
Part No.	952 010
Max. continuous operating voltage (a.c.) (U_c)	275 V

**N-PE Spark-Gap-Based Protection Module for DEHNgard M TT ...**

N-PE spark-gap-based protection module for two-pole and four-pole DEHNgard DG M TT ... surge arresters.

Type	DG MOD NPE
Part No.	952 050
Max. continuous operating voltage (a.c.) (U_c)	255 V



DEHNguard® SE CI with integrated Backup Fuse

- Arrester backup fuse integrated in the protection module
- For use in case of higher rated voltages
- Energy coordination with other arresters of the Red/Line product family
- High discharge capacity
- High reliability due to “Thermo Dynamic Control” SPD device monitoring
- Easy replacement of protection modules without tools due to module locking system with module release button



For protecting low-voltage consumer's installations against surges. For installation in conformity with the lightning protection zone concept at the boundaries from $O_B - 1$ and higher.

- DEHNguard SE CI 440 FM:** Modular single-pole surge arrester with integrated backup fuse (floating changeover contact)
DEHNguard SE CI WE 440 FM: Modular single-pole surge arrester with integrated backup fuse particularly for use in wind turbines (floating changeover contact)

The modular surge arrester of the DEHNguard SE CI product family for systems with higher rated voltages of 400 / 690 V is available as type DG SE CI 440 FM and DG SE CI WE 440 FM. Type WE is equipped with a varistor of 750 V rated voltage and therefore is perfectly suited for converter operation with voltage peaks, for example in wind turbines.

With the already integrated arrester backup fuse the user no longer has to care about arrester-specific dimensioning requirements such as backup protection in the event of short-circuit and impulse current carrying capability.

Highest system availability even in case of higher voltages due to the ideal matching of SPD and integrated backup fuse. The integrated backup fuse has been developed especially for this case of application. It is not designed for continuous current but rather for impulse current and short-circuit protection which ensures optimal performance. The fuse only being tripped in case of end of SPD's service life, separate replacement is not necessary.

Due to the “Thermo Dynamic Control” monitoring device, the surface temperature of the heavy-duty varistor and the intensity of the discharge

current are used for evaluation. The operating state of each protective path is shown by means of a mechanical indicator with green and red indicator flags which needs no power to operate. It also indicates the activation of the “Thermo Dynamic-Control” monitoring device and of the integrated arrester backup fuse.

In addition to this mechanical operating state/fault indication the versions of the DEHNguard SE CI (WE) 440 FM devices feature a three-pole remote signalling terminal. With its floating changeover contact, the remote signal can be used as break or make contact according to the particular circuit concept.

All benefits of the modular design of the DEHNguard family have been integrated into the new DEHNguard SE CI family.

The unique module locking system prevents the protection modules from becoming loose due to vibration during transport or the enormous forces of discharge.

The pluggable protection modules are mechanically coded which is an additional safety feature of these DEHN + SÖHNE devices and ensures against installing an incorrect protection module.

NEW



DEHNgard SE CI 440 FM

Modular single-pole surge arrester comprising a base part and a plug-in protection module; with integrated backup fuse and remote signalling contact for monitoring unit (floating changeover contact).

Type DG SE CI ...	440 FM
Part No.	952 920 <small>NEW</small>
SPD according to EN 61643-11 / IEC 61643-11	type 2 / class II
Max. continuous operating voltage (a.c.) (U_c)	440 V (50 / 60 Hz)
Nominal discharge current (8/20 μ s) (I_n)	12.5 kA
Voltage protection level (U_p)	≤ 2 kV
Max. mains-side overcurrent protection	not required
Type of remote signalling contact	changeover contact

NEW



DEHNgard SE CI WE 440 FM

Modular single-pole surge arrester with a rated varistor voltage $U_{mov} = 750$ V a.c.; comprising a base part and a plug-in protection module; with integrated backup fuse and remote signalling contact for monitoring unit (floating changeover contact).

Type DG SE CI ...	WE 440 FM
Part No.	952 923 <small>NEW</small>
SPD according to EN 61643-11 / IEC 61643-11	type 2 / class II
Max. continuous operating voltage (a.c.) (U_c)	440 V (50 / 60 Hz)
Rated varistor voltage (a.c.) (U_{mov})	750 V
Nominal discharge current (8/20 μ s) (I_n)	12.5 kA
Voltage protection level (U_p)	≤ 3 kV
Max. mains-side overcurrent protection	not required
Type of remote signalling contact	changeover contact

Accessories for DEHNgard® SE CI with integrated Backup Fuse

NEW



Varistor-based Protection Module for DEHNgard SE CI (WE)

Type	DG MOD E CI 440	DG MOD E CI WE 440
Part No.	952 926 <small>NEW</small>	952 927 <small>NEW</small>
Max. continuous operating voltage (d.c.) (U_c)	440 V	440 V
Rated varistor voltage (a.c.) (U_{mov})	440 V	750 V



DEHNgard® modular

- Prewired complete unit consisting of a base part and plug-in protection modules
- Energy coordination with other arresters of the Red/Line product family
- High discharge capacity due to heavy-duty zinc oxide varistors / spark gaps
- High reliability due to “Thermo Dynamic Control” SPD monitoring device
- Easy replacement of protection modules without tools due to module locking system with module release button
- Vibration and shock-tested according to EN 60068-2

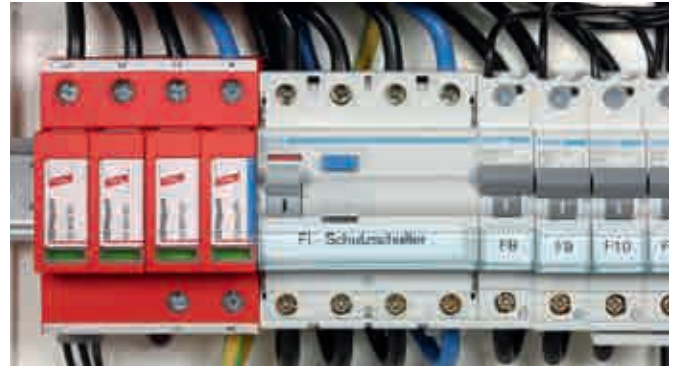

For protecting low-voltage consumer's installations against surges. For installation in conformity with the lightning protection zone concept at the boundaries from $O_B - 1$ and higher.

DEHNgard M TNC ...:	Modular surge arrester for use in TN-C systems
DEHNgard M TNS ...:	Modular surge arrester for use in TN-S systems
DEHNgard M H TT ...:	Modular surge arrester with an increased discharge capacity for use in TT and TN-S systems (3+1 configuration)
DEHNgard M TT ...:	Modular surge arrester for use in TT and TN-S systems (3+1 configuration)
DEHNgard M TN ...:	Modular surge arrester for use in single-phase TN systems
DEHNgard M H TT 2P ...:	Modular surge arrester with an increased discharge capacity for single-phase TT and TN systems (1+1 configuration)
DEHNgard M TT 2P ...:	Modular surge arrester for use in single-phase TT and TN systems (1+1 configuration)
DEHNgard M WE ...:	Modular surge arrester especially for use in wind turbines
DEHNgard M ... NL:	With neutral left
DEHNgard M ... FM:	With remote signalling contact for monitoring device (floating changeover contact)

Featuring the functional Red/Line family design, the modular DEHNgard M ... surge arresters set new standards in terms of safety and ease of use. The proven protective circuit with heavy-duty zinc oxide varistors in combination with the dual “Thermo Dynamic Control” monitoring device are characteristic of the DEHNgard technology.

A variety of features shows that both reliable surge protection and equipment safety are key elements of the modular DEHNgard surge arresters. The application-based product designation, which makes it considerably easier to choose the correct device for the relevant application, as well as the unique module locking system stand for fulfilling the most stringent safety requirements. The module locking system firmly fixes the protection modules to the base part. Neither vibration during transport nor the enormous forces of discharge can loosen the protection modules. Nevertheless, they can be easily replaced without tools by simply pressing the easy-to-use module release button of the protection modules. Each protective circuit of the multipole surge arresters and each protection module are mechanically coded to ensure against installing an incorrect module.

The dual “Thermo Dynamic Control” monitoring device was not only developed on the basis of national and international product standards, but also stands for experience of decades in the world market of surge protective devices and considers many practical applications where arresters might be damaged. As with all DEHN surge arresters with “Thermo Dynamic Control”, the surface temperature of the heavy-duty varistor and the intensity of the discharge current are used for evaluation. The visual indicator with green and red indicator flags shows the availability of every protective circuit. Apart from this standard visual indication, DEHNgard M ... FM devices feature a three-pole remote signalling terminal.

With its floating changeover contact, the remote signal can be used as a make or break contract according to the particular circuit concept. The surge arresters of the modular multipole DEHNgard M family feature multifunctional terminals on a standardised spacing of 1 module for the connection of conductors and busbars, allowing easy wiring with other DIN rail mounted devices. The STAK 25 pin-shaped terminal, which is compatible with all DEHNgard modules, allows optimal series connection according to IEC 60364-5-53.

The DEHNgard M H TT ... type already meets the requirements of the new VDE 0100-534 standard (Table: Discharge values I_n in a 3+1 configuration for three-phase systems with increased safety requirements). This table requires at least 40 kA for the N-PE path. Since a discharge capacity of 80 kA was technically feasible, arithmetically correct dimensioning ($4 \times 20 \text{ kA} = 80 \text{ kA}$) in combination with the standard varistor-based modules with $I_n = 20 \text{ kA}$ is ensured.

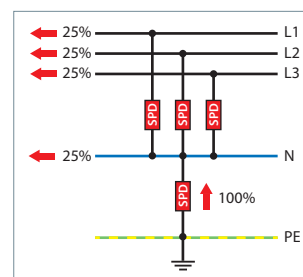

3+1 configuration with an increased discharge capacity $4 \times 20 \text{ kA} = 80 \text{ kA}$.

DEHNgard M TNC ...

Modular surge arrester for use in TN-C systems (3+0 configuration).



Type DG M ...	TNC 150	TNC 275	TNC 385	TNC 440
Part No.	952 313	952 300	952 314	952 303
SPD according to EN 61643-11 / IEC 61643-11	type 2 / class II	type 2 / class II	type 2 / class II	type 2 / class II
Max. continuous operating voltage (a.c.) (U _c)	150 V (50 / 60 Hz)	275 V (50 / 60 Hz)	385 V (50 / 60 Hz)	440 V (50 / 60 Hz)
Nominal discharge current (8/20 μs) (I _n)	15 kA	20 kA	20 kA	20 kA
Max. discharge current (8/20 μs) (I _{max})	40 kA	40 kA	40 kA	40 kA
Voltage protection level (U _p)	≤ 0.7 kV	≤ 1.5 kV	≤ 1.75 kV	≤ 2 kV
Max. mains-side overcurrent protection	125 A gG	125 A gG	125 A gG	125 A gG
Approvals	KEMA, UL	KEMA, VDE, UL	KEMA, UL	KEMA, UL

DEHNgard M TNC ... FM

Modular surge arrester for use in TN-C systems (3+0 configuration); with floating changeover contact.



Type DG M ...	TNC 150 FM	TNC 275 FM	TNC 385 FM	TNC 440 FM
Part No.	952 318	952 305	952 319	952 308
SPD according to EN 61643-11 / IEC 61643-11	type 2 / class II	type 2 / class II	type 2 / class II	type 2 / class II
Max. continuous operating voltage (a.c.) (U _c)	150 V (50 / 60 Hz)	275 V (50 / 60 Hz)	385 V (50 / 60 Hz)	440 V (50 / 60 Hz)
Nominal discharge current (8/20 μs) (I _n)	15 kA	20 kA	20 kA	20 kA
Max. discharge current (8/20 μs) (I _{max})	40 kA	40 kA	40 kA	40 kA
Voltage protection level (U _p)	≤ 0.7 kV	≤ 1.5 kV	≤ 1.75 kV	≤ 2 kV
Max. mains-side overcurrent protection	125 A gG	125 A gG	125 A gG	125 A gG
Approvals	KEMA, UL	KEMA, VDE, UL	KEMA, UL	KEMA, UL
Type of remote signalling contact	changeover contact	changeover contact	changeover contact	changeover contact

DEHNgard M TNS ...

Modular surge arrester for use in TN-S systems (4+0 configuration).



Type DG M ...	TNS 150	TNS 275	TNS 385
Part No.	952 403	952 400	952 404
SPD according to EN 61643-11 / IEC 61643-11	type 2 / class II	type 2 / class II	type 2 / class II
Max. continuous operating voltage (a.c.) (U _c)	150 V (50 / 60 Hz)	275 V (50 / 60 Hz)	385 V (50 / 60 Hz)
Nominal discharge current (8/20 μs) (I _n)	15 kA	20 kA	20 kA
Max. discharge current (8/20 μs) (I _{max})	40 kA	40 kA	40 kA
Voltage protection level [L-PE]/[N-PE] (U _p)	≤ 0.7 / ≤ 0.7 kV	≤ 1.5 / ≤ 1.5 kV	≤ 1.75 / ≤ 1.75 kV
Max. mains-side overcurrent protection	125 A gG	125 A gG	125 A gG
Approvals	KEMA, UL	KEMA, VDE, UL	KEMA, UL

DEHNgard M TNS ... FM

Modular surge arrester for use in TN-S systems (4+0 configuration); with floating changeover contact.



Type DG M ...	TNS 150 FM	TNS 275 FM	TNS 385 FM
Part No.	952 408	952 405	952 409
SPD according to EN 61643-11 / IEC 61643-11	type 2 / class II	type 2 / class II	type 2 / class II
Max. continuous operating voltage (a.c.) (U _c)	150 V (50 / 60 Hz)	275 V (50 / 60 Hz)	385 V (50 / 60 Hz)
Nominal discharge current (8/20 μs) (I _n)	15 kA	20 kA	20 kA
Max. discharge current (8/20 μs) (I _{max})	40 kA	40 kA	40 kA
Voltage protection level [L-PE]/[N-PE] (U _p)	≤ 0.7 / ≤ 0.7 kV	≤ 1.5 / ≤ 1.5 kV	≤ 1.75 / ≤ 1.75 kV
Max. mains-side overcurrent protection	125 A gG	125 A gG	125 A gG
Approvals	KEMA, UL	KEMA, VDE, UL	KEMA, UL
Type of remote signalling contact	changeover contact	changeover contact	changeover contact

DEHNgard M TNS 275 NL (FM)

Modular surge arrester for TN-S systems, neutral conductor on the left side



Type DG M ...	TNS 275 NL	TNS 275 NL FM
Part No.	952 402	952 407
SPD according to EN 61643-11 / IEC 61643-11	type 2 / class II	type 2 / class II
Max. continuous operating voltage (a.c.) (U _c)	275 V (50 / 60 Hz)	275 V (50 / 60 Hz)
Nominal discharge current (8/20 μs) (I _n)	20 kA	20 kA
Max. discharge current (8/20 μs) (I _{max})	40 kA	40 kA
Voltage protection level (U _p)	≤ 1.5 kV	≤ 1.5 kV
Max. mains-side overcurrent protection	125 A gG	125 A gG
Approvals	KEMA, VDE, UL	KEMA, VDE, UL
Type of remote signalling contact	—	changeover contact

DEHNgard M H TT ... (FM)

Modular surge arrester with a high total discharge capacity in the N-PE path for TT and TN-S systems (3+1 configuration); meets the increased safety requirements according to the new VDE 0100-534 standard for use at the origin at the electrical installation; with floating remote signalling contact.

Type DG M ...	H TT 275	H TT 275 FM
Part No.	952 381	952 385
SPD according to EN 61643-11 / IEC 61643-11	type 2 / class II	type 2 / class II
Max. continuous operating voltage (a.c.) [L-N] (U_C)	275 V (50 / 60 Hz)	275 V (50 / 60 Hz)
Nominal discharge current (8/20 μ s) [L-N] (I_n)	20 kA	20 kA
Nominal discharge current (8/20 μ s) [N-PE] (I_n)	80 kA	80 kA
Max. discharge current (8/20 μ s) [L-N] (I_{max})	40 kA	40 kA
Max. discharge current (8/20 μ s) [N-PE] (I_{max})	120 kA	120 kA
Voltage protection level [L-N]/[N-PE] (U_P)	$\leq 1.5 / \leq 1.5$ kV	$\leq 1.5 / \leq 1.5$ kV
Max. mains-side overcurrent protection	125 A gG	125 A gG
Approvals	KEMA	KEMA
Type of remote signalling contact	—	changeover contact



DEHNgard M TT ...

Modular surge arrester for use in TT and TN-S systems (3+1 configuration).

Type DG M ...	TT 150	TT 275	TT 320	TT 385
Part No.	952 323	952 310	952 320	952 311
SPD according to EN 61643-11 / IEC 61643-11	type 2 / class II	type 2 / class II	type 2 / class II	type 2 / class II
Max. continuous operating voltage (a.c.) [L-N] (U_C)	150 V (50 / 60 Hz)	275 V (50 / 60 Hz)	320 V (50 / 60 Hz)	385 V (50 / 60 Hz)
Nominal discharge current (8/20 μ s) (I_n)	15 kA	20 kA	20 kA	20 kA
Max. discharge current (8/20 μ s) (I_{max})	40 kA	40 kA	40 kA	40 kA
Voltage protection level [L-N]/[N-PE] (U_P)	$\leq 0.7 / \leq 1.5$ kV	$\leq 1.5 / \leq 1.5$ kV	$\leq 1.5 / \leq 1.5$ kV	$\leq 1.75 / \leq 1.5$ kV
Max. mains-side overcurrent protection	125 A gG	125 A gG	125 A gG	125 A gG
Approvals	—	KEMA, VDE, UL	KEMA	KEMA, UL



DEHNgard M TT ... FM

Modular surge arrester for use in TT and TN-S systems (3+1 configuration); with floating remote signalling contact.

Type DG M ...	TT 150 FM	TT 275 FM	TT 320 FM	TT 385 FM
Part No.	952 328	952 315	952 325	952 316
SPD according to EN 61643-11 / IEC 61643-11	type 2 / class II	type 2 / class II	type 2 / class II	type 2 / class II
Max. continuous operating voltage (a.c.) [L-N] (U_C)	150 V (50 / 60 Hz)	275 V (50 / 60 Hz)	320 V (50 / 60 Hz)	385 V (50 / 60 Hz)
Nominal discharge current (8/20 μ s) (I_n)	15 kA	20 kA	20 kA	20 kA
Max. discharge current (8/20 μ s) (I_{max})	40 kA	40 kA	40 kA	40 kA
Voltage protection level [L-N]/[N-PE] (U_P)	$\leq 0.7 / \leq 1.5$ kV	$\leq 1.5 / \leq 1.5$ kV	$\leq 1.5 / \leq 1.5$ kV	$\leq 1.75 / \leq 1.5$ kV
Max. mains-side overcurrent protection	125 A gG	125 A gG	125 A gG	125 A gG
Approvals	UL	KEMA, VDE, UL	KEMA	KEMA, UL
Type of remote signalling contact	changeover contact	changeover contact	changeover contact	changeover contact



DEHNgard M TT 275 NL (FM)

Modular surge arrester for TT and TN-S systems (3+1 configuration), neutral conductor on the left side.

Type DG M ...	TT 275 NL	TT 275 NL FM
Part No.	952 312	952 317
SPD according to EN 61643-11 / IEC 61643-11	type 2 / class II	type 2 / class II
Max. continuous operating voltage (a.c.) [L-N] (U_C)	275 V (50 / 60 Hz)	275 V (50 / 60 Hz)
Nominal discharge current (8/20 μ s) (I_n)	20 kA	20 kA
Max. discharge current (8/20 μ s) (I_{max})	40 kA	40 kA
Voltage protection level [L-N] (U_P)	≤ 1.5 kV	≤ 1.5 kV
Voltage protection level [N-PE] (U_P)	≤ 1.5 kV	≤ 1.5 kV
Max. mains-side overcurrent protection	125 A gG	125 A gG
Approvals	KEMA, VDE, UL	KEMA, VDE, UL
Type of remote signalling contact	—	changeover contact



DEHNgard M TN ...

Modular surge arrester for use in single-phase TN systems (2+0 configuration).



Type DG M ...	TN 150	TN 275
Part No.	952 201	952 200
SPD according to EN 61643-11 / IEC 61643-11	type 2 / class II	type 2 / class II
Max. continuous operating voltage (a.c.) (U_c)	150 V (50 / 60 Hz)	275 V (50 / 60 Hz)
Nominal discharge current (8/20 μ s) (I_n)	15 kA	20 kA
Max. discharge current (8/20 μ s) (I_{max})	40 kA	40 kA
Voltage protection level [L-PE]/[N-PE] (U_p)	$\leq 0.7 / \leq 0.7$ kV	$\leq 1.5 / \leq 1.5$ kV
Max. mains-side overcurrent protection	125 A gG	125 A gG
Approvals	KEMA, UL	KEMA, VDE, UL

DEHNgard M TN ... FM

Modular surge arrester for use in single-phase TN systems (2+0 configuration); with floating remote signalling contact.



Type DG M ...	TN 150 FM	TN 275 FM
Part No.	952 206	952 205
SPD according to EN 61643-11 / IEC 61643-11	type 2 / class II	type 2 / class II
Max. continuous operating voltage (a.c.) (U_c)	150 V (50 / 60 Hz)	275 V (50 / 60 Hz)
Nominal discharge current (8/20 μ s) (I_n)	15 kA	20 kA
Max. discharge current (8/20 μ s) (I_{max})	40 kA	40 kA
Voltage protection level [L-PE]/[N-PE] (U_p)	$\leq 0.7 / \leq 0.7$ kV	$\leq 1.5 / \leq 1.5$ kV
Max. mains-side overcurrent protection	125 A gG	125 A gG
Approvals	KEMA, UL	KEMA, VDE, UL
Type of remote signalling contact	changeover contact	changeover contact

DEHNgard M TN 275 NL (FM)

Modular surge arrester for single-phase 230 V TN systems, neutral conductor on the left side



Type DG M ...	TN 275 NL	TN 275 NL FM
Part No.	952 202	952 207
SPD according to EN 61643-11 / IEC 61643-11	type 2 / class II	type 2 / class II
Max. continuous operating voltage (a.c.) (U_c)	275 V (50 / 60 Hz)	275 V (50 / 60 Hz)
Nominal discharge current (8/20 μ s) (I_n)	20 kA	20 kA
Max. discharge current (8/20 μ s) (I_{max})	40 kA	40 kA
Voltage protection level (U_p)	≤ 1.5 kV	≤ 1.5 kV
Max. mains-side overcurrent protection	125 A gG	125 A gG
Approvals	KEMA, VDE, UL	KEMA, VDE, UL
Type of remote signalling contact	—	changeover contact

DEHNgard M H TT 2P ... (FM)

Modular surge arrester with a high total discharge capacity in the N-PE path for TT and TN systems (1+1 configuration); meets the increased safety requirements according to the new VDE 100-534 standard for use at the origin at the electrical installation; with floating remote signalling contact.



Type DG M ...	H TT 2P 275	H TT 2P 275 FM
Part No.	952 181	952 185
SPD according to EN 61643-11 / IEC 61643-11	type 2 / class II	type 2 / class II
Max. continuous operating voltage (a.c.) [L-N] (U_c)	275 V (50 / 60 Hz)	275 V (50 / 60 Hz)
Nominal discharge current (8/20 μ s) [L-N] (I_n)	20 kA	20 kA
Nominal discharge current (8/20 μ s) [N-PE] (I_n)	80 kA	80 kA
Max. discharge current (8/20 μ s) [L-N] (I_{max})	40 kA	40 kA
Max. discharge current (8/20 μ s) [N-PE] (I_{max})	120 kA	120 kA
Voltage protection level [L-N]/[N-PE] (U_p)	$\leq 1.5 / \leq 1.5$ kV	$\leq 1.5 / \leq 1.5$ kV
Max. mains-side overcurrent protection	125 A gG	125 A gG
Approvals	KEMA	KEMA
Type of remote signalling contact	—	changeover contact

DEHNgard M TT 2P ...

Modular surge arrester for use in single-phase TT and TN systems (1+1 configuration).

Type DG M ...	TT 2P 275	TT 2P 320	TT 2P 385
Part No.	952 110	952 130	952 111
SPD according to EN 61643-11 / IEC 61643-11	type 2 / class II	type 2 / class II	type 2 / class II
Max. continuous operating voltage (a.c.) [L-N] (U_C)	275 V (50 / 60 Hz)	320 V (50 / 60 Hz)	385 V (50 / 60 Hz)
Nominal discharge current (8/20 μ s) (I_n)	20 kA	20 kA	20 kA
Max. discharge current (8/20 μ s) (I_{max})	40 kA	40 kA	40 kA
Voltage protection level [L-N]/[N-PE] (U_P)	$\leq 1.5 / \leq 1.5$ kV	$\leq 1.5 / \leq 1.5$ kV	$\leq 1.75 / \leq 1.5$ kV
Max. mains-side overcurrent protection	125 A gG	125 A gG	125 A gG
Approvals	KEMA, VDE, UL	KEMA	KEMA



DEHNgard M TT 2P ... FM

Modular surge arrester for use in single-phase TT and TN systems (1+1 configuration); with floating remote signalling contact.

Type DG M ...	TT 2P 275 FM	TT 2P 320 FM	TT 2P 385 FM
Part No.	952 115	952 135	952 116
SPD according to EN 61643-11 / IEC 61643-11	type 2 / class II	type 2 / class II	type 2 / class II
Max. continuous operating voltage (a.c.) [L-N] (U_C)	275 V (50 / 60 Hz)	320 V (50 / 60 Hz)	385 V (50 / 60 Hz)
Nominal discharge current (8/20 μ s) (I_n)	20 kA	20 kA	20 kA
Max. discharge current (8/20 μ s) (I_{max})	40 kA	40 kA	40 kA
Voltage protection level [L-N]/[N-PE] (U_P)	$\leq 1.5 / \leq 1.5$ kV	$\leq 1.5 / \leq 1.5$ kV	$\leq 1.75 / \leq 1.5$ kV
Max. mains-side overcurrent protection	125 A gG	125 A gG	125 A gG
Approvals	KEMA, VDE, UL	KEMA	KEMA
Type of remote signalling contact	changeover contact	changeover contact	changeover contact



DEHNgard M TT 2P 275 NL (FM)

Modular surge arrester for single-phase 230 V TT and TN systems (1+1 configuration), neutral conductor on the left side

Type DG M ...	TT 2P 275 NL	TT 2P 275 NL FM
Part No.	952 112	952 117
SPD according to EN 61643-11 / IEC 61643-11	type 2 / class II	type 2 / class II
Max. continuous operating voltage (a.c.) [L-N] (U_C)	275 V (50 / 60 Hz)	275 V (50 / 60 Hz)
Nominal discharge current (8/20 μ s) (I_n)	20 kA	20 kA
Max. discharge current (8/20 μ s) (I_{max})	40 kA	40 kA
Voltage protection level [L-N] (U_P)	≤ 1.5 kV	≤ 1.5 kV
Voltage protection level [N-PE] (U_P)	≤ 1.5 kV	≤ 1.5 kV
Max. mains-side overcurrent protection	125 A gG	125 A gG
Approvals	KEMA, VDE, UL	KEMA, VDE, UL
Type of remote signalling contact	—	changeover contact



DEHNgard M WE ... (FM)

Modular surge arrester (3+0 configuration) with a rated varistor voltage $U_{mov} = 750$ V a.c.; FM version with floating remote signalling contact.

Type DG M ...	WE 600	WE 600 FM
Part No.	952 302	952 307
SPD according to EN 61643-11 / IEC 61643-11	type 2 / class II	type 2 / class II
Max. continuous operating voltage (a.c.) (U_C)	600 V (50 / 60 Hz)	600 V (50 / 60 Hz)
Rated varistor voltage (U_{mov})	750 V	750 V
Nominal discharge current (8/20 μ s) (I_n)	15 kA	15 kA
Max. discharge current (8/20 μ s) (I_{max})	25 kA	25 kA
Voltage protection level (U_P)	≤ 3 kV	≤ 3 kV
Max. mains-side overcurrent protection	100 A gG	100 A gG
Approvals	KEMA, UL	KEMA, UL
Type of remote signalling contact	—	changeover contact



Accessories for DEHNguard® modular

**Varistor-Based Protection Module**

Varistor-based protection module for DEHNguard M ... and DEHNguard S ... surge arresters.

Type	DG MOD 150	DG MOD 275	DG MOD 320	DG MOD 385	DG MOD 440
Part No.	952 012	952 010	952 013	952 014	952 015
Max. continuous operating voltage (a.c.) (U _c)	150 V	275 V	320 V	385 V	440 V

**Varistor-Based Protection Module for DEHNguard M (S) WE**

Varistor-based protection module for DEHNguard M WE ... and DEHNguard S WE ... surge arresters with a rated varistor voltage U_{mov} = 750 V a.c.

Type	DG MOD 750
Part No.	952 017
Max. continuous operating voltage (a.c.) (U _c)	600 V

**N-PE Spark-Gap-Based Protection Module for DEHNguard M H TT ...**

N-PE spark-gap-based protection module with a high discharge capacity for two-pole and four-pole DEHNguard DG M H TT ... surge arresters.

Type	DG MOD H NPE
Part No.	952 081
Max. continuous operating a.c. voltage (U _c)	255 V

**N-PE Spark-Gap-Based Protection Module for DEHNguard M TT ...**

N-PE spark-gap-based protection module for two-pole and four-pole DEHNguard DG M TT ... surge arresters.

Type	DG MOD NPE
Part No.	952 050
Max. continuous operating voltage (a.c.) (U _c)	255 V



DEHNgard® 5 kA (NL)

- High reliability due to “Thermo Dynamic Control” monitoring system
- Easy installation and retrofitting thanks to narrow design (width of 18/36 mm)
- Application-optimised discharge capacity of 5 kA (I_n) / 15 kA (I_{max}) (8/20 μ s) per pole
- Energy coordination with other arresters of the Red/Line family operating state / fault indication by green / red indicator flag in the inspection window
- Vibration and shock-tested according to EN 60068-2



For protecting low voltage consumer's installations against surges. For installation in conformity with the lightning protection zone concept at the boundaries from $O_B - 1$ and higher.

DG TT 2P 5 275 (NL) : Compact surge arrester for single-phase TT and TN systems (1+1 configuration)

DG TT 5 275 (NL) : Compact surge arrester for TT and TN-S systems (3+1 configuration)

The compact surge arresters of the DEHNgard TT 5 275 (NL) series complement the proven DEHNgard M family for applications with reduced technical parameters.

DEHNgard TT ... 5 275 (NL) arresters takes up little space and are therefore ideally suited for retrofitting into existing installations and applications with restricted space. Consequently, the devices can be used to protect individual parts of installations (e.g. lighting systems or pumps). In case of multi-phase application, e.g. in TT systems (3+1), the arresters only require two modules. Since the devices can be used up to 63 A without additional backup fuse, easy and cost-optimised installation of surge protective devices is ensured.

In this context, the safety-relevant features of the DEHNgard series were not neglected. The DEHNgard 5 kA devices are provided with a “Thermo

Dynamic Control” monitoring device which meets the high safety standards for surge arresters.

The dual Thermo Dynamic Control monitoring device is not only developed based on applicable national and international product standards, but also stands for experience of decades in the world market of surge protective devices and considers many practical applications where arresters might be damaged.

The standard mechanical operating state / fault indication reliably indicates the status of the surge protective device.

Consequently, the devices of the DEHNgard TT 5 275 (NL) series are ideally suited for retrofitting, applications with restricted space and reduced technical requirements.

DEHNgard TT 2P 5 275 (NL)

Compact surge arrester for single-phase TT and TN systems (1+1 circuit); version NL with neutral left

Type DG TT ...	2P 5 275	2P 5 275 NL
Part No.	900 450	900 458
SPD according to EN 61643-11	type 2	type 2
Max. continuous operating voltage (a.c.) [L-N] (U_C)	275 V (50 / 60 Hz)	275 V (50 / 60 Hz)
Max. continuous operating voltage (a.c.) [N-PE] (U_C)	255 V (50 / 60 Hz)	255 V (50 / 60 Hz)
Nominal discharge current (8/20 μ s) [L-N] (I_n)	5 kA	5 kA
Nominal discharge current (8/20 μ s) [N-PE] (I_n)	20 kA	20 kA
Max. discharge current (8/20 μ s) [L-N] (I_{max})	15 kA	15 kA
Max. discharge current (8/20 μ s) [N-PE] (I_{max})	40 kA	40 kA
Voltage protection level (U_P)	≤ 1.5 kV	≤ 1.5 kV
Max. mains-side overcurrent protection	MCB C 63 A	MCB C 63 A



DEHNgard TT 5 275 (NL)

Compact surge arrester for TT and TN-S systems (3+1 circuit); version NL with neutral left

Type DG TT ...	5 275	5 275 NL
Part No.	900 455	900 459
SPD according to EN 61643-11	type 2	type 2
Max. continuous operating voltage (a.c.) [L-N] (U_C)	275 V (50 / 60 Hz)	275 V (50 / 60 Hz)
Max. continuous operating voltage (a.c.) [N-PE] (U_C)	255 V (50 / 60 Hz)	255 V (50 / 60 Hz)
Nominal discharge current (8/20 μ s) [L-N] (I_n)	5 kA	5 kA
Nominal discharge current (8/20 μ s) [N-PE] (I_n)	20 kA	20 kA
Max. discharge current (8/20 μ s) [L-N] (I_{max})	15 kA	15 kA
Max. discharge current (8/20 μ s) [N-PE] (I_{max})	40 kA	40 kA
Voltage protection level (U_P)	≤ 1.5 kV	≤ 1.5 kV
Max. mains-side overcurrent protection	MCB C 63 A	MCB C 63 A





DEHNgard® S



For protecting low-voltage consumer's installations against surges. For installation in conformity with the lightning protection zone concept at the boundaries from $O_B - 1$ and higher.

- Multi-purpose surge arrester consisting of a base part and a plug-in protection module
- High discharge capacity due to heavy-duty zinc oxide varistor
- High reliability due to "Thermo Dynamic Control" SPD monitoring device
- Energy coordination with other arresters of the Red/Line product family
- Operating state/fault indication by green/red indicator flag in the inspection window
- Narrow (modular) design acc. to DIN 43880
- Multifunctional terminals for connecting conductors and busbars
- Easy replacement of protection modules due to module locking system with module release button
- Vibration and shock-tested according to EN 60068-2

DEHNgard S ...: Pluggable surge arrester consisting of a base part and a plug-in protection module
 DEHNgard S ... FM: With remote signalling contact for monitoring device (floating changeover contact)

The universal features characterise the single-pole devices of the DEHNgard S product family. Whether as a single device or in combination with other devices – DEHNgard S surge arresters always provide adequate protection. The modern Red/Line family design and its universal features ensure safety and easy application for the user. The module release button and the approved "Thermo Dynamic Control" SPD monitoring device with dual tripping performance characterise the devices of the DEHNgard S series.

Experience of decades in the world market of surge arresters has further improved the latest DEHNgard generation compared to the previous devices.

The unique module locking system fixes the protection module to the base part. Neither vibration during transport nor the enormous forces of discharge can loosen this connection. Nevertheless, the modules can be easily replaced without tools by simply pressing the easy-to-use module release button of the protection modules.

Every base part and protection module is mechanically coded to ensure against installing an incorrect module.

As with all DEHNgard surge arresters, the user of DEHNgard S can rely on the dual "Thermo Dynamic Control" SPD monitoring device which ensures a maximum degree of safety, even under harsh environmental conditions. The green and red indicator flags show the operating state of DEHNgard S surge arresters. Apart from this standard visual indication, DEHNgard S ... FM features a three-pole remote signalling terminal. With its floating changeover contact, the remote signal can be used as a break or make contact according to the particular circuit concept. The multifunctional terminals of DEHNgard S surge arresters are suitable for connecting conductors and busbars, allowing easy wiring with other DIN rail mounted devices. Thus, a wide range of applications can be easily connected in series according to IEC 60364-5-53 for optimal protection.

DEHNgard S ...

Pluggable single-pole surge arrester consisting of a base part and a plug-in protection module.

General Information:				
SPD according to EN 61643-11 / IEC 61643-11	type 2 / class II			
Type DG S ...	48	75	150	275
Part No.	952 078	952 071	952 072	952 070
Max. continuous operating voltage (a.c.) (U_C)	48 V (50 / 60 Hz)	75 V (50 / 60 Hz)	150 V (50 / 60 Hz)	275 V (50 / 60 Hz)
Max. continuous operating voltage (d.c.) (U_C)	60 V	100 V	200 V	350 V
Nominal discharge current (8/20 μ s) (I_n)	7.5 kA	10 kA	15 kA	20 kA
Max. discharge current (8/20 μ s) (I_{max})	25 kA	40 kA	40 kA	40 kA
Voltage protection level (U_p)	≤ 0.33 kV	≤ 0.4 kV	≤ 0.7 kV	≤ 1.5 kV
Max. mains-side overcurrent protection	125 A gG	125 A gG	125 A gG	125 A gG
Approvals	—	KEMA, VDE, UL, CSA	KEMA, VDE, UL, CSA	KEMA, VDE, UL, CSA
Type DG S ...	320	385	440	600
Part No.	952 073	952 074	952 075	952 076
Max. continuous operating voltage (a.c.) (U_C)	320 V (50 / 60 Hz)	385 V (50 / 60 Hz)	440 V (50 / 60 Hz)	600 V (50 / 60 Hz)
Max. continuous operating voltage (d.c.) (U_C)	420 V	500 V	585 V	600 V
Nominal discharge current (8/20 μ s) (I_n)	20 kA	20 kA	20 kA	15 kA
Max. discharge current (8/20 μ s) (I_{max})	40 kA	40 kA	40 kA	30 kA
Voltage protection level (U_p)	≤ 1.5 kV	≤ 1.75 kV	≤ 2 kV	≤ 2.5 kV
Max. mains-side overcurrent protection	125 A gG	125 A gG	125 A gG	100 A gG
Approvals	KEMA, VDE, UL, CSA	KEMA, VDE, UL, CSA	KEMA, VDE, UL, CSA	KEMA, VDE, UL, CSA



Surge Arresters – Type 2

DEHNgard S ... FM

Pluggable single-pole surge arrester consisting of a base part and a plug-in protection module; with floating remote signalling contact.

General Information:				
SPD according to EN 61643-11 / IEC 61643-11	type 2 / class II			
Type of remote signalling contact	changeover contact			
Type DG S ...	48 FM	75 FM	150 FM	275 FM
Part No.	952 098	952 091	952 092	952 090
Max. continuous operating voltage (a.c.) (U_c)	48 V (50 / 60 Hz)	75 V (50 / 60 Hz)	150 V (50 / 60 Hz)	275 V (50 / 60 Hz)
Max. continuous operating voltage (d.c.) (U_c)	60 V	100 V	200 V	350 V
Nominal discharge current (8/20 μ s) (I_n)	7.5 kA	10 kA	15 kA	20 kA
Max. discharge current (8/20 μ s) (I_{max})	25 kA	40 kA	40 kA	40 kA
Voltage protection level (U_P)	≤ 0.33 kV	≤ 0.4 kV	≤ 0.7 kV	≤ 1.5 kV
Max. mains-side overcurrent protection	125 A gG	125 A gG	125 A gG	125 A gG
Approvals	—	KEMA, VDE, UL, CSA	KEMA, VDE, UL, CSA	KEMA, VDE, UL, CSA
Type DG S ...	320 FM	385 FM	440 FM	600 FM
Part No.	952 093	952 094	952 095	952 096
Max. continuous operating voltage (a.c.) (U_c)	320 V (50 / 60 Hz)	385 V (50 / 60 Hz)	440 V (50 / 60 Hz)	600 V (50 / 60 Hz)
Max. continuous operating voltage (d.c.) (U_c)	420 V	500 V	585 V	600 V
Nominal discharge current (8/20 μ s) (I_n)	20 kA	20 kA	20 kA	15 kA
Max. discharge current (8/20 μ s) (I_{max})	40 kA	40 kA	40 kA	30 kA
Voltage protection level (U_P)	≤ 1.5 kV	≤ 1.75 kV	≤ 2 kV	≤ 2.5 kV
Max. mains-side overcurrent protection	125 A gG	125 A gG	125 A gG	100 A gG
Approvals	KEMA, VDE, UL, CSA	KEMA, VDE, UL, CSA	KEMA, VDE, UL, CSA	KEMA, VDE, UL, CSA



DEHNgard S WE 600 (FM)

Pluggable single-pole surge arrester with a rated varistor voltage $U_{mov} = 750$ V a.c., consisting of base part and a plug-in protection module; FM version with floating remote signalling contact.

Type DG S ...	WE 600	WE 600 FM
Part No.	952 077	952 097
SPD according to EN 61643-11 / IEC 61643-11	type 2 / class II	type 2 / class II
Max. continuous operating voltage (a.c.) (U_c)	600 V (50 / 60 Hz)	600 V (50 / 60 Hz)
Nominal discharge current (8/20 μ s) (I_n)	15 kA	15 kA
Max. discharge current (8/20 μ s) (I_{max})	25 kA	25 kA
Voltage protection level (U_P)	≤ 3 kV	≤ 3 kV
Max. mains-side overcurrent protection	100 A gG	100 A gG
Approvals	KEMA, UL, CSA	KEMA, UL, CSA
Type of remote signalling contact	—	changeover contact



Accessories for DEHNgard® S

Varistor-Based Protection Module

Varistor-based protection module for DEHNgard M ... and DEHNgard S ... surge arresters.

Type	DG MOD 48	DG MOD 75	DG MOD 150	DG MOD 275
Part No.	952 018	952 011	952 012	952 010
Max. continuous operating voltage (a.c.) (U_c)	48 V	75 V	150 V	275 V
Type	DG MOD 320	DG MOD 385	DG MOD 440	DG MOD 600
Part No.	952 013	952 014	952 015	952 016
Max. continuous operating voltage (a.c.) (U_c)	320 V	385 V	440 V	600 V



Varistor-Based Protection Module for DEHNgard M (S) WE

Varistor-based protection module for DEHNgard M WE ... and DEHNgard S WE ... surge arresters with a rated varistor voltage $U_{mov} = 750$ V a.c.

Type	DG MOD 750
Part No.	952 017
Max. continuous operating voltage (a.c.) (U_c)	600 V





DEHNGuard® S ... VA



For protecting low-voltage consumer's installations against surges. For installation in conformity with the lightning protection zone concept at the boundaries from $O_B - 1$ and higher.

- Multi-purpose surge arrester consisting of a base part and a plug-in protection module
- Leakage-current-free series connection of a varistor and a spark gap in the pluggable protection module
- High reliability due to "Thermo Dynamic Control" SPD monitoring device
- Energy coordination with other arresters of the Red/Line product family
- Easy replacement of protection modules without tools due to module locking system with module release button
- Narrow (modular) design according to DIN 43880
- Multifunctional terminal for connecting conductors and busbars

DEHNGuard S ... VA: Modular single-pole surge arrester with a varistor connected in series with a spark gap in the pluggable protection module

DEHNGuard S ... VA FM: Modular single-pole surge arrester with a varistor connected in series with a spark gap in the pluggable protection module; with remote signalling contact for monitoring device (floating changeover contact)

The single-pole DEHNGuard S ... VA surge arresters are an ideal supplement to the proven DEHNGuard product families. The special series connection of a spark gap and a varistor in the protection module opens up new fields of application. It is advisable to use DEHNGuard S ... VA devices to protect, for example, systems with permanent insulation monitoring and the traction power lines in railway systems where complete absence of leakage currents is required. DEHNGuard S ... VA surge arresters are also suited for protecting power line communication systems.

Multifunctional terminals allow almost unlimited flexibility of connection to one another, but also to other DIN rail mounted devices on the distribution board. However, it is not only flexibility that characterises the DEHNGuard S ... VA family. Its distinctive performance parameters set standards worldwide:

A high discharge capacity, complete absence of leakage currents, a low voltage protection level and the dual "Thermo Dynamic Control" monitoring and disconnection device describe the high degree of reliability.

The DEHN-specific "Thermo Dynamic Control" disconnecter ensures that the arresters enter a safe and isolated state, even in case of extreme overload. For this purpose, the surface temperature of the heavy-duty varistor and the intensity of the discharge current are used for evaluation. In addition to the standard visual indication with red and green indicator flags, the DEHNGuard S VA ... FM devices feature a three-pole remote signalling terminal. With its floating changeover contact, the remote signal can be used as break or make contact according to the particular protection concept.

DEHNGuard S VA

Modular single-pole surge arrester with a varistor connected in series with a spark gap in the pluggable protection module.

Type DG S ...	75 VA	275 VA	385 VA
Part No.	952 080	952 082	952 084
SPD according to EN 61643-11 / IEC 61643-11	type 2 / class II	type 2 / class II	type 2 / class II
Max. continuous operating voltage (a.c.) (U_C)	75 V (50 / 60 Hz)	275 V (50 / 60 Hz)	385 V (50 / 60 Hz)
Nominal discharge current (8/20 μ s) (I_n)	10 kA	10 kA	10 kA
Max. discharge current (8/20 μ s) (I_{max})	20 kA	20 kA	20 kA
Voltage protection level (U_p)	≤ 1.1 kV	≤ 1.5 kV	≤ 1.75 kV
Max. mains-side overcurrent protection	100 A gG	100 A gG	100 A gG

DEHNGuard S VA FM

Modular single-pole surge arrester with a varistor connected in series with a spark gap in the pluggable protection module; with floating remote signalling contact.

Type DG S ...	75 VA FM	275 VA FM	385 VA FM
Part No.	952 085	952 087	952 089
SPD according to EN 61643-11 / IEC 61643-11	type 2 / class II	type 2 / class II	type 2 / class II
Max. continuous operating voltage (a.c.) (U_C)	75 V (50 / 60 Hz)	275 V (50 / 60 Hz)	385 V (50 / 60 Hz)
Nominal discharge current (8/20 μ s) (I_n)	10 kA	10 kA	10 kA
Max. discharge current (8/20 μ s) (I_{max})	20 kA	20 kA	20 kA
Voltage protection level (U_p)	≤ 1.1 kV	≤ 1.5 kV	≤ 1.75 kV
Max. mains-side overcurrent protection	100 A gG	100 A gG	100 A gG

Accessories for DEHNGuard® S ... VA

Varistor-Based Protection Module for DEHNGuard S ... VA

Protection module for DEHNGuard S ... VA arresters comprising a varistor connected in series with a spark gap.

Type	DG MOD 75 VA	DG MOD 275 VA	DG MOD 385 VA
Part No.	952 025	952 027	952 029
Max. continuous operating voltage (a.c.) (U_C)	75 V	275 V	385 V





DEHNgard® SE H ... FM

- Universal surge arrester comprising a base part and a plug-in protection module
- Prewired single-pole surge arrester with clear “Lifetime Indication”
- Three-step “Lifetime Indication” (green-yellow-red) linked with remote signalling contact
- High discharge capacity I_{max} up to 65 kA (8/20 μ s)
- Prompts the user in time <YELLOW> to replace the protection module in case of imminent arrester overload; early warning system
- The arrester is fully operational until the protection module is replaced and is thus suited for use in condition monitoring systems
- Energy coordination with other arresters of the Red/Line product family
- Easy replacement of protection modules without tools due to module locking system with module release button



Single-pole surge arrester with integrated “Lifetime Indication” early warning system. For protecting low-voltage consumer’s installations from surges. For installation in conformity with the lightning protection zone concept at the boundaries from $O_B - 1$ and higher.

- DEHNgard SE H LI ... FM:** Pluggable single-pole surge arrester with three-step early warning system (green-yellow-red) comprising a base part and a plug-in protection module; with remote signalling contact for monitoring unit (floating changeover contact)
- DEHNgard SE H 1000 FM:** Pluggable single-pole surge arrester with a high discharge capacity comprising a base part and a plug-in protection module; with remote signalling contact for monitoring unit (floating changeover contact)
- DEHNgard SE H 1000 VA FM:** Pluggable single-pole surge arrester with a high discharge capacity and a varistor connected in series with a spark gap comprising a base part and a plug-in protection module; with remote signalling contact for monitoring unit (floating changeover contact)

The single-pole type 2 DEHNgard SE H LI ... FM surge arresters with a functional Red/Line design provide a high degree of safety and comfort and ensure maximum availability of electrical installations.

The three-step “Lifetime Indication” provides reliable information on the operating state of the surge protective device. The yellow indication shows that a certain energy has pre-damaged the arrester during its lifetime. Moreover, the remote signalling contact is activated so that the arrester can be easily integrated condition monitoring systems. During this yellow indication, the connected electrical equipment is still protected against surges since the protection module is fully operational. Now the protection module can be replaced in time (without disconnecting the mains voltage and removing the distribution board cover) – Before further energies overload the arrester and the installation is unprotected! Thus, the lifetime between commissioning (green indication) and disconnection (red indication) of DEHNgard SE H LI ... FM consists of two periods: After typically 70% of the total nominal discharge current load, the indication changes from green to yellow. Consequently, about 30% of the total load capacity remain for the yellow phase during which the surge protective device is fully operational. This makes this indication an ideal early warning system!

The single-pole devices are available for voltages from 275 V to 1000 V a.c. and are thus universally applicable. In addition, the product family has a high discharge capacity I_{max} up to 65 kA (8/20 μ s) and is thus more powerful across all voltage levels than conventional type 2 arresters.

The devices feature the special modular Red/Line family design with a width of 1.5 modules to implement the variety of functions. They can be used as a single device or in combination with other devices and always provide adequate protection. All necessary components such as earthing clips EB 1 ... 1.5 with modular dimensions of 1.5 modules are available as accessory to ensure the correct connection for the relevant system configuration as per IEC 60364-5-53.

Consequently, the intelligent DEHNgard SE H LI ... FM family allows to protect installations which require maximum availability such as data centres, power plants or wind turbines against surges. Planned maintenance for type 2 surge protective devices can be easily and efficiently performed in all low-voltage installations.

Both the three-step monitoring unit of the surge protective devices and the coded plug-in protection module types underline the high degree of safety of the arrester and damage caused by installing an incorrect module can be virtually excluded.

In addition to the standard three-step visual indication, the arresters feature a three-pole remote signalling terminal. With its floating changeover contact, the remote signal can be used as a break or make contact according to the particular circuit concept.

The DEHNgard SE H 1000 FM type is a special arrester of the DEHNgard ... H ... series. Compared to the LI devices, whose designation includes the abbreviation “LI”, it features a two-step visual indication which changes from green to red as soon as the max. load capacity of the arrester is reached and activates the floating changeover contact.

The DEHNgard SE H 1000 VA FM type is a particularly powerful type 2 arrester designed for high voltages and discharge currents. Due to the high nominal voltage and the series connection of a varistor and a gas discharge tube, it is ideally suited for wind turbines (rotor and inverter), but also for other applications such as PV systems, railway systems or cable cars with high voltages where absence of leakage current is required.

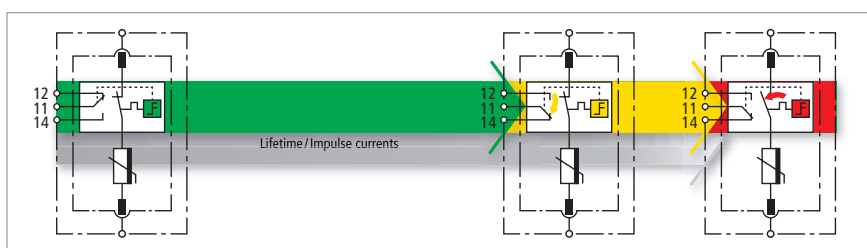

DEHNgard SE H LI ... FM

Pluggable single-pole surge arrester with three-step early warning system (green-yellow-red) comprising a base part and a plug-in protection module; with floating remote signalling contact.



Type DG SE H ...	LI 275 FM	LI 1000 FM
Part No.	952 930	952 937
SPD according to EN 61643-11 / IEC 61643-11	type 2 / class II	type 2 / class II
Max. continuous operating voltage (a.c.) (U_c)	275 V (50 / 60 Hz)	1000 V (50 / 60 Hz)
Nominal discharge current (8/20 μ s) (I_n)	30 kA	20 kA
Max. discharge current (8/20 μ s) (I_{max})	65 kA	40 kA
Voltage protection level (U_p)	≤ 1.5 kV	≤ 4.5 kV
Max. mains-side overcurrent protection	125 A gG	100 A gG
Operating state / fault indication	green / yellow / red	green / yellow / red
Type of remote signalling contact	changeover contact	changeover contact

DEHNgard SE H 1000 FM

Pluggable single-pole surge arrester comprising a base part and a plug-in protection module; with floating remote signalling contact.



Type DG SE H ...	1000 FM
Part No.	952 938
SPD according to EN 61643-11 / IEC 61643-11	type 2 / class II
Max. continuous operating voltage (a.c.) (U_c)	1000 V (50 / 60 Hz)
Nominal discharge current (8/20 μ s) (I_n)	20 kA
Max. discharge current (8/20 μ s) (I_{max})	40 kA
Voltage protection level (U_p)	≤ 4.5 kV
Max. mains-side overcurrent protection	100 A gG
Operating state / fault indication	green / red
Type of remote signalling contact	changeover contact

DEHNgard SE H 1000 VA FM

Pluggable single-pole surge arrester comprising a base part and a plug-in protection module; with floating remote signalling contact. Series connection of a varistor and a gas discharge tube.



Type DG SE H ...	1000 VA FM
Part No.	952 940
SPD according to EN 61643-11 / IEC 61643-11	type 2 / class II
Max. continuous operating voltage (a.c.) (U_c)	1000 V (50 / 60 Hz)
Nominal discharge current (8/20 μ s) (I_n)	15 kA
Max. discharge current (8/20 μ s) (I_{max})	40 kA
Voltage protection level (U_p)	≤ 5 kV
Max. mains-side overcurrent protection	100 A gG
Operating state / fault indication	green / red
Approvals	UL
Type of remote signalling contact	changeover contact
Supplementary data:	
– Sparkover voltage gas discharge tube (U_{agmin})	2200 V

Accessories for DEHNgard® SE H ... FM



Varistor-based Protection Module for DEHNgard SE H ... FM

Type DG MOD ...	E H LI 275	E H LI 1000	E H 1000	E H 1000 VA
Part No.	952 900	952 907	952 908	952 918
Max. continuous operating voltage (a.c.) (U_c)	275 V	1000 V	1000 V	1000 V

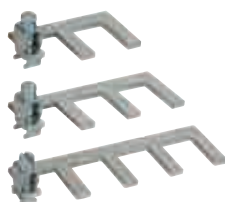

Earthing Clip for 1.5-module Enclosures, single-phase, two-pole / three-pole / four-pole

Earthing clip for connecting the earth terminal of e.g. two / three / four SPDs with 1.5-module enclosure to earth, with terminal.

Type	EB 1 2 1.5	EB 1 3 1.5	EB 1 4 1.5
Part No.	900 460	900 418	900 429
Dimensions	34 x 60 x 28 mm	34 x 85 x 28 mm	34 x 112 x 28 mm
Terminal	up to 25 mm ²	up to 25 mm ²	up to 25 mm ²



DEHNguard® modular for North America

- Prewired complete unit consisting of a base part and plug-in protection modules
- No need for additional overcurrent protection devices
- Short circuit current rating (SCCR) 200 kA
- ANSI/UL 1449 – 4th Ed. Open-Type 1 SPD
- High discharge capacity due to heavy-duty zinc oxide varistors (I_{max} 50 kA 8x 20 μ s)
- High reliability due to “Thermo Dynamic Control” SPD monitoring device

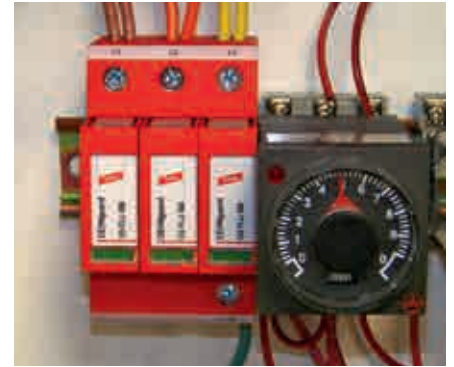

DEHNguard SU 1P ...:	Modular single-pole surge arrester for application in Single Phase electrical systems
DEHNguard MU SP ...:	Modular surge arrester for application in Split Phase systems
DEHNguard MU SPN ...:	Modular surge arrester for application in Split Phase systems (with N protected)
DEHNguard MU CGD ...:	Modular surge arrester for application in Corner Grounded Delta systems
DEHNguard MU 3PY ...:	Modular surge arrester for application in 3 Phase Wye electrical systems
DEHNguard MU 3PD ...:	Modular surge arrester for application in 3 Phase Delta electrical systems
DEHNguard MU 3PH ...:	Modular surge arrester for application in 3 Phase High-leg Delta systems
DEHNguard ... R:	With remote status indicator for monitoring device (Form C / SPDT contact)

The DEHNguard SU/MU ... surge arresters are modular DIN rail mounted SPDs in the functional Red/Line family design and set new standards in terms of safety and user-friendliness. The SPDs are UL 1449 4th Edition certified as Type 1 Component Assemblies and are designed for all common electrical power systems. These Devices have optimised Voltage Protection Ratings and therefore provide ideal surge protection for the United States and Canadian electrical panel markets.

The enhanced maximum discharge capacity of 50 kA, the high short circuit current rating (SCCR) of 200 kA and the fact that there is no need for additional overcurrent protection devices make the DEHNguard SU/MU product family fulfil all requirements of nowadays electrical applications. Besides the variety of features shows that both reliable surge protection and equipment safety are key elements of the modular DEHNguard surge arresters. The application-based product designation, which makes it considerably easier to choose the correct device for the relevant application, as well as the module locking system firmly fixes the protection modules to the base part. Neither vibration during transport nor the enormous electromagnetic forces of discharge can loosen the protection modules. Nevertheless, they can be easily replaced without tools by simply pressing the user-friendly module release button of the protection modules. Each

protective circuit of the multipole surge arresters and each protection module are mechanically coded to ensure against installing an incorrect module.

The dual “Thermo Dynamic Control” monitoring device was not only developed on the basis of national and international product standards, but also stands for experience of decades in the world market of surge protective devices and considers practical applications where arresters might be damaged. As with all DEHN surge arresters with “Thermo Dynamic Control”, the intensity of the discharge current and the surface temperature of the heavy-duty varistor are evaluated. The visual status indicator with green and red indicator flags shows the availability of every protective circuit. Apart from this standard visual indication, DEHNguard M SU/MU ... FM devices feature a Form C contact (SPDT).

With its floating changeover contact, the remote signal can be used as a make or break contact according to the particular circuit concept. The surge arresters of the multipole modular DEHNguard MU family feature multifunctional terminals on a standardised spacing of 1 module for the connection of wires and busbars, allowing easy wiring with other DIN rail mounted devices. Thus, a wide range of applications can be easily connected in series for optimal protection.

DEHNguard MU 3PY ... 3W+G

DIN rail mount, pluggable surge arrester consisting of a base part and plug-in protection modules for application in 3 Phase Wye electrical systems

Type DG MU ...	3PY 208 3W+G	3PY 480 3W+G	3PY 600 3W+G
Part No.	908 300	908 314	908 301
SPD classification acc. to ANSI/UL 1449 4 th Ed.	Open-Type 1 SPD	Open-Type 1 SPD	Open-Type 1 SPD
SPD classification acc. to CSA - C22.2 No. 269.1-14	Type 4-1 Component Assembly	Type 4-1 Component Assembly	Type 4-1 Component Assembly
Max. continuous operating voltage AC [L-G] / [L-L] (MCOV)	180 V a.c. / 360 V a.c.	385 V a.c. / 770 V a.c.	510 V a.c. / 1020 V a.c.
Nominal discharge current (8x 20 μ s) (I_n)	20 kA	20 kA	20 kA
Max. discharge current (8/20) (I_{max})	50 kA	50 kA	50 kA
Voltage Protection Rating [L-G] / [L-L] (VPR)	600 V _{pk} / 1200 V _{pk}	1200 V _{pk} / 2500 V _{pk}	1500 V _{pk} / 3000 V _{pk}
Max. mains-side overcurrent protection	Not needed	Not needed	Not needed
Approvals	UL, CSA	UL, CSA	UL, CSA



DEHNgard MU 3PY ... 3W+G R

DIN rail mount, pluggable surge arrester consisting of a base part and plug-in protection modules for application in 3 Phase Wye electrical systems; has floating Form C (SPDT) remote status contacts



Type DG MU ...	3PY 208 3W+G R	3PY 480 3W+G R	3PY 600 3W+G R
Part No.	908 305	908 319	908 306
SPD classification acc. to ANSI/UL 1449 4 th Ed.	Open-Type 1 SPD	Open-Type 1 SPD	Open-Type 1 SPD
SPD classification acc. to CSA - C22.2 No. 269.1-14	Type 4-1 Component Assembly	Type 4-1 Component Assembly	Type 4-1 Component Assembly
Max. continuous operating voltage AC [L-G] / [L-L] (MCOV)	180 V a.c. / 360 V a.c.	385 V a.c. / 770 V a.c.	510 V a.c. / 1020 V a.c.
Nominal discharge current (8x 20 μs) (I _n)	20 kA	20 kA	20 kA
Max. discharge current (8/20) (I _{max})	50 kA	50 kA	50 kA
Voltage Protection Rating [L-G] / [L-L] (VPR)	600 V _{pk} / 1200 V _{pk}	1200 V _{pk} / 2500 V _{pk}	1500 V _{pk} / 3000 V _{pk}
Max. mains-side overcurrent protection	Not needed	Not needed	Not needed
Approvals	UL, CSA	UL, CSA	UL, CSA
Remote status contact	Floating (dry), Form C (SPDT)	Floating (dry), Form C (SPDT)	Floating (dry), Form C (SPDT)

DEHNgard MU 3PD ... 3W+G

DIN rail mount, pluggable surge arrester consisting of a base part and plug-in protection modules for application in 3 Phase Delta electrical systems



Type DG MU ...	3PD 480 3W+G	3PD 240 3W+G
Part No.	908 350	908 351
SPD classification acc. to ANSI/UL 1449 4 th Ed.	Open-Type 1 SPD	Open-Type 1 SPD
SPD classification acc. to CSA - C22.2 No. 269.1-14	Type 4-1 Component Assembly	Type 4-1 Component Assembly
Max. continuous operating voltage AC [L-G] / [L-L] (MCOV)	550 V a.c. / 1100 V a.c.	275 V a.c. / 550 V a.c.
Nominal discharge current (8x20μs) (I _n)	20 kA	20 kA
Max. discharge current (8/20) (I _{max})	50 kA	50 kA
Voltage Protection Rating [L-G] / [L-L] (VPR)	1800 V _{pk} / 3000 V _{pk}	800 V _{pk} / 1500 V _{pk}
Max. mains-side overcurrent protection	Not needed	Not needed
Approvals	UL, CSA	UL, CSA

DEHNgard MU 3PD ... 3W+G R

DIN rail mount, pluggable surge arrester consisting of a base part and plug-in protection modules for application in 3 Phase Delta electrical systems; has floating Form C (SPDT) remote status contacts



Type DG MU ...	3PD 480 3W+G R	3PD 240 3W+G R
Part No.	908 355	908 356
SPD classification acc. to ANSI/UL 1449 4 th Ed.	Open-Type 1 SPD	Open-Type 1 SPD
SPD classification acc. to CSA - C22.2 No. 269.1-14	Type 4-1 Component Assembly	Type 4-1 Component Assembly
Max. continuous operating voltage AC [L-G] / [L-L] (MCOV)	550 V a.c. / 1100 V a.c.	275 V a.c. / 550 V a.c.
Nominal discharge current (8x20μs) (I _n)	20 kA	20 kA
Max. discharge current (8/20) (I _{max})	50 kA	50 kA
Voltage Protection Rating [L-G] / [L-L] (VPR)	1800 V _{pk} / 3000 V _{pk}	800 V _{pk} / 1500 V _{pk}
Max. mains-side overcurrent protection	Not needed	Not needed
Approvals	UL, CSA	UL, CSA
Remote status contact	Floating (dry), Form C (SPDT)	Floating (dry), Form C (SPDT)

DEHNgard MU 3PY ... 4W+G

DIN rail mount, pluggable surge arrester consisting of a base part and plug-in protection modules for application in 3 Phase Wye Systems



Type DG MU ...	3PY 208 4W+G	3PY 480 4W+G	3PY 600 4W+G
Part No.	908 340	908 341	908 342
SPD classification acc. to ANSI/UL 1449 4 th Ed.	Open-Type 1 SPD	Open-Type 1 SPD	Open-Type 1 SPD
SPD classification acc. to CSA - C22.2 No. 269.1-14	Type 4-1 Component Assembly	Type 4-1 Component Assembly	Type 4-1 Component Assembly
Max. continuous operating voltage AC [L-N] / [L-G] / [L-L] / [N-G] (MCOV)	180 V a.c. / 360 V a.c. / 360 V a.c. / 180 V a.c.	385 V a.c. / 565 V a.c. / 770 V a.c. / 180 V a.c.	510 V a.c. / 690 V a.c. / 1020 V a.c. / 180 V a.c.
Nominal discharge current (8x 20 μs) (I _n)	20 kA	20 kA	20 kA
Max. discharge current (8/20) (I _{max})	50 kA	50 kA	50 kA
Voltage Protection Rating [L-N] / [L-G] / [L-L] / [N-G] (VPR)	600 V _{pk} / 1200 V _{pk} / 1200 V _{pk} / 600 V _{pk}	1200 V _{pk} / 1800 V _{pk} / 2500 V _{pk} / 600 V _{pk}	1500 V _{pk} / 2000 V _{pk} / 3000 V _{pk} / 600 V _{pk}
Max. mains-side overcurrent protection	Not needed	Not needed	Not needed
Approvals	UL, CSA	UL, CSA	UL, CSA

Surge Arresters – Type 2

DEHNgard MU 3PY ... 4W+ G R

DIN rail mount, pluggable surge arrester consisting of a base part and plug-in protection modules for application in 3 Phase Wye Systems; has floating Form C (SPDT) remote status contacts

Type DG MU ...	3PY 208 4W+G R	3PY 480 4W+G R	3PY 600 4W+G R
Part No.	908 345	908 346	908 347
SPD classification acc. to ANSI/UL 1449 4 th Ed.	Open-Type 1 SPD	Open-Type 1 SPD	Open-Type 1 SPD
SPD classification acc. to CSA - C22.2 No. 269.1-14	Type 4-1 Component Assembly	Type 4-1 Component Assembly	Type 4-1 Component Assembly
Max. continuous operating voltage AC [L-N] / [L-G] / [L-L] / [N-G] (MCOV)	180 V a.c. / 360 V a.c. / 360 V a.c. / 180 V a.c.	385 V a.c. / 565 V a.c. / 770 V a.c. / 180 V a.c.	510 V a.c. / 690 V a.c. / 1020 V a.c. / 180 V a.c.
Nominal discharge current (8x 20 μs) (I _n)	20 kA	20 kA	20 kA
Max. discharge current (8/20) (I _{max})	50 kA	50 kA	50 kA
Voltage Protection Rating [L-N] / [L-G] / [L-L] / [N-G] (VPR)	600 V _{pk} / 1200 V _{pk} / 1200 V _{pk} / 600 V _{pk}	1200 V _{pk} / 1800 V _{pk} / 2500 V _{pk} / 600 V _{pk}	1500 V _{pk} / 2000 V _{pk} / 3000 V _{pk} / 600 V _{pk}
Max. mains-side overcurrent protection	Not needed	Not needed	Not needed
Approvals	UL, CSA	UL, CSA	UL, CSA
Remote status contact	Floating (dry), Form C (SPDT)	Floating (dry), Form C (SPDT)	Floating (dry), Form C (SPDT)



DEHNgard MU 3PH ... 4W+G

DIN rail mount, pluggable surge arrester consisting of a base part and plug-in protection modules for application in 3 Phase High-leg Delta Systems

Type DG MU ...	3PH 240 4W+G	3PH 480 4W+G
Part No.	908 343	908 344
SPD classification acc. to ANSI/UL 1449 4 th Ed.	Open-Type 1 SPD	Open-Type 1 SPD
SPD classification acc. to CSA - C22.2 No. 269.1-14	Type 4-1 Component Assembly	Type 4-1 Component Assembly
Max. continuous operating voltage AC [L-N] / [H-N] / [L-G] / [H-G] / [L-L] / [L-H] / [N-G]	230 V a.c. / 275 V a.c. / 410 V a.c. / 455 V a.c. / 460 V a.c. / 505 V a.c. / 180 V a.c.	385 V a.c. / 510 V a.c. / 565 V a.c. / 690 V a.c. / 770 V a.c. / 895 V a.c. / 180 V a.c.
Nominal discharge current (8x 20 μs) (I _n)	20 kA	20 kA
Max. discharge current (8/20) (I _{max})	50 kA	50 kA
Voltage Protection Rating [L-N] / [H-N] / [L-G] / [H-G] / [L-L] / [L-H] / [N-G] (VPR)	700 V _{pk} / 800 V _{pk} / 1200 V _{pk} / 1500 V _{pk} / 1500 V _{pk} / 1500 V _{pk} / 600 V _{pk}	1200 V _{pk} / 1500 V _{pk} / 1800 V _{pk} / 2000 V _{pk} / 2500 V _{pk} / 2500 V _{pk} / 600 V _{pk}
Max. mains-side overcurrent protection	Not needed	Not needed
Approvals	UL, CSA	UL, CSA



DEHNgard MU 3PH ... 4W+G R

DIN rail mount, pluggable surge arrester consisting of a base part and plug-in protection modules for application in 3 Phase High-leg Delta Systems; has floating Form C (SPDT) remote status contacts

Type DG MU ...	3PH 240 4W+G R	3PH 480 4W+G R
Part No.	908 348	908 349
SPD classification acc. to ANSI/UL 1449 4 th Ed.	Open-Type 1 SPD	Open-Type 1 SPD
SPD classification acc. to CSA - C22.2 No. 269.1-14	Type 4-1 Component Assembly	Type 4-1 Component Assembly
Max. continuous operating voltage AC [L-N] / [H-N] / [L-G] / [H-G] / [L-L] / [L-H] / [N-G]	230 V a.c. / 275 V a.c. / 410 V a.c. / 455 V a.c. / 460 V a.c. / 505 V a.c. / 180 V a.c.	385 V a.c. / 510 V a.c. / 565 V a.c. / 690 V a.c. / 770 V a.c. / 895 V a.c. / 180 V a.c.
Nominal discharge current (8x 20 μs) (I _n)	20 kA	20 kA
Max. discharge current (8/20) (I _{max})	50 kA	50 kA
Voltage Protection Rating [L-N] / [H-N] / [L-G] / [H-G] / [L-L] / [L-H] / [N-G] (VPR)	700 V _{pk} / 800 V _{pk} / 1200 V _{pk} / 1500 V _{pk} / 1500 V _{pk} / 1500 V _{pk} / 600 V _{pk}	1200 V _{pk} / 1500 V _{pk} / 1800 V _{pk} / 2000 V _{pk} / 2500 V _{pk} / 2500 V _{pk} / 600 V _{pk}
Max. mains-side overcurrent protection	Not needed	Not needed
Approvals	UL, CSA	UL, CSA
Remote status contact	Floating (dry), Form C (SPDT)	Floating (dry), Form C (SPDT)



DEHNgard MU SP ... 3W+G

DIN rail mount, pluggable surge arrester consisting of a base part and plug-in protection modules for application in Split Phase systems

Type DG MU ...	SP 240 3W+G	SP 480 3W+G
Part No.	908 190	908 192
SPD classification acc. to ANSI/UL 1449 4 th Ed.	Open-Type 1 SPD	Open-Type 1 SPD
SPD classification acc. to CSA - C22.2 No. 269.1-14	Type 4-1 Component Assembly	Type 4-1 Component Assembly
Max. continuous operating voltage AC [L-G] / [L-L] (MCOV)	230 V a.c. / 460 V a.c.	385 V a.c. / 770 V a.c.
Nominal discharge current (8x 20 μs) (I _n)	20 kA	20 kA
Max. discharge current (8/20) (I _{max})	50 kA	50 kA
Voltage Protection Rating [L-G] / [L-L] (VPR)	700 V _{pk} / 1500 V _{pk}	1200 V _{pk} / 2500 V _{pk}
Max. mains-side overcurrent protection	Not needed	Not needed
Approvals	UL, CSA	UL, CSA



DEHNgard MU SP ... 3W+G R

DIN rail mount, pluggable surge arrester consisting of a base part and plug-in protection modules for application in Split Phase systems; has floating Form C (SPDT) remote status contacts



Type DG MU ...	SP 240 3W+G R	SP 480 3W+G R
Part No.	908 195	908 197
SPD classification acc. to ANSI/UL 1449 4 th Ed.	Open-Type 1 SPD	Open-Type 1 SPD
SPD classification acc. to CSA - C22.2 No. 269.1-14	Type 4-1 Component Assembly	Type 4-1 Component Assembly
Max. continuous operating voltage AC [L-G] / [L-L] (MCOV)	230 V a.c. / 460 V a.c.	385 V a.c. / 770 V a.c.
Nominal discharge current (8x 20 μs) (I _n)	20 kA	20 kA
Max. discharge current (8/20) (I _{max})	50 kA	50 kA
Voltage Protection Rating [L-G] / [L-L] (VPR)	700 V _{pk} / 1500 V _{pk}	1200 V _{pk} / 2500 V _{pk}
Max. mains-side overcurrent protection	Not needed	Not needed
Approvals	UL, CSA	UL, CSA
Remote status contact	Floating (dry), Form C (SPDT)	Floating (dry), Form C (SPDT)

DEHNgard MU SPN ... 3W+G

DIN rail mount, pluggable surge arrester consisting of a base part and plug-in protection modules for application in Split Phase systems



Type DG MU ...	SPN 240 3W+G
Part No.	908 214
SPD classification acc. to ANSI/UL 1449 4 th Ed.	Open-Type 1 SPD
SPD classification acc. to CSA - C22.2 No. 269.1-14	Type 4-1 Component Assembly
Max. continuous operating voltage AC [L-N] / [L-G] / [L-L] / [N-G] (MCOV)	180 V a.c. / 360 V a.c. / 360 V a.c. / 180 V a.c.
Nominal discharge current (8x 20 μs) (I _n)	20 kA
Max. discharge current (8/20) (I _{max})	50 kA
Voltage Protection Rating [L-N] / [L-G] / [L-L] / [N-G] (VPR)	600 V _{pk} / 1200 V _{pk} / 1200 V _{pk} / 600 V _{pk}
Max. mains-side overcurrent protection	Not needed
Approvals	UL, CSA

DEHNgard MU SPN ... 3W+G R

DIN rail mount, pluggable surge arrester consisting of a base part and plug-in protection modules for application in 3 Split Phase systems; has floating Form C (SPDT) remote status contacts



Type DG MU ...	SPN 240 3W+G R
Part No.	908 219
SPD classification acc. to ANSI/UL 1449 4 th Ed.	Open-Type 1 SPD
SPD classification acc. to CSA - C22.2 No. 269.1-14	Type 4-1 Component Assembly
Max. continuous operating voltage AC [L-N] / [L-G] / [L-L] / [N-G] (MCOV)	180 V a.c. / 360 V a.c. / 360 V a.c. / 180 V a.c.
Nominal discharge current (8x 20 μs) (I _n)	20 kA
Max. discharge current (8/20) (I _{max})	50 kA
Voltage Protection Rating [L-N] / [L-G] / [L-L] / [N-G] (VPR)	600 V _{pk} / 1200 V _{pk} / 1200 V _{pk} / 600 V _{pk}
Max. mains-side overcurrent protection	Not needed
Approvals	UL, CSA
Remote status contact	Floating (dry), Form C (SPDT)

DEHNgard MU CGD ... 3W+G

DIN rail mount, pluggable surge arrester consisting of a base part and plug-in protection modules for application in Corner Grounded Delta systems.



Type DG MU ...	CGD 240 3W+G	CGD 480 3W+G
Part No.	908 203	908 204
SPD classification acc. to ANSI/UL 1449 4 th Ed.	Open-Type 1 SPD	Open-Type 1 SPD
SPD classification acc. to CSA - C22.2 No. 269.1-14	Type 4-1 Component Assembly	Type 4-1 Component Assembly
Max. continuous operating voltage AC [L-G] / [L-L] (MCOV)	275 V a.c. / 550 V a.c.	550 V a.c. / 1100 V a.c.
Nominal discharge current (8x 20 μs) (I _n)	20 kA	20 kA
Max. discharge current (8/20) (I _{max})	50 kA	50 kA
Voltage Protection Rating [L-G] / [L-L] (VPR)	800 V _{pk} / 1500 V _{pk}	1800 V _{pk} / 3000 V _{pk}
Max. mains-side overcurrent protection	Not needed	Not needed
Approvals	UL, CSA	UL, CSA

DEHNgard MU CGD ... 3W+G R

DIN rail mount, pluggable surge arrester consisting of a base part and plug-in protection modules for application in Corner Grounded Delta systems; has floating Form C (SPDT) remote status contacts

Type DG MU ...	CGD 240 3W+G R	CGD 480 3W+G R
Part No.	908 208	908 209
SPD classification acc. to ANSI/UL 1449 4 th Ed.	Open-Type 1 SPD	Open-Type 1 SPD
SPD classification acc. to CSA - C22.2 No. 269.1-14	Type 4-1 Component Assembly	Type 4-1 Component Assembly
Max. continuous operating voltage AC [L-G] / [L-L] (MCOV)	275 V a.c. / 550 V a.c.	550 V a.c. / 1100 V a.c.
Nominal discharge current (8x 20 μs) (I _n)	20 kA	20 kA
Max. discharge current (8/20) (I _{max})	50 kA	50 kA
Voltage Protection Rating [L-G] / [L-L] (VPR)	800 V _{pk} / 1500 V _{pk}	1800 V / 3000 V
Max. mains-side overcurrent protection	Not needed	Not needed
Approvals	UL, CSA	UL, CSA
Remote status contact	Floating (dry), Form C (SPDT)	Floating (dry), Form C (SPDT)



DEHNgard SU 1P ...

DIN rail mount, pluggable surge arrester consisting of a base part and plug-in protection module for application in Single Phase electrical systems.

Type DG SU ...	1P 120	1P 240	1P 347
Part No.	908 070	908 074	908 076
SPD classification acc. to ANSI/UL 1449 4 th Ed.	Open-Type 1 SPD	Open-Type 1 SPD	Open-Type 1 SPD
SPD classification acc. to CSA - C22.2 No. 269.1-14	Type 4-1 Component Assembly	Type 4-1 Component Assembly	Type 4-1 Component Assembly
Max. continuous operating voltage AC [L-L] (MCOV)	230 Vac	385 Vac	510 Vac
Nominal discharge current (8x 20 μs) (I _n)	20 kA	20 kA	20 kA
Max. discharge current (8/20) (I _{max})	50 kA	50 kA	50 kA
Voltage Protection Rating [L-L] (VPR)	700 V _{pk}	1200 V _{pk}	1500 V _{pk}
Max. mains-side overcurrent protection	Not needed	Not needed	Not needed
Approvals	UL, CSA	UL, CSA	UL, CSA



DEHNgard SU 1P ... R

DIN rail mount, pluggable surge arrester consisting of a base part and plug-in protection module for application in Single Phase electrical systems; has floating Form C (SPDT) remote status contacts

Type DG SU ...	1P 120 R	1P 240 R	1P 347 R
Part No.	908 090	908 094	908 096
SPD classification acc. to ANSI/UL 1449 4 th Ed.	Open-Type 1 SPD	Open-Type 1 SPD	Open-Type 1 SPD
SPD classification acc. to CSA - C22.2 No. 269.1-14	Type 4-1 Component Assembly	Type 4-1 Component Assembly	Type 4-1 Component Assembly
Max. continuous operating voltage AC [L-L] (MCOV)	230 Vac	385 Vac	510 Vac
Nominal discharge current (8x20μs) (I _n)	20 kA	20 kA	20 kA
Max. discharge current (8/20) (I _{max})	50 kA	50 kA	50 kA
Voltage Protection Rating [L-L] (VPR)	700 V _{pk}	1200 V _{pk}	1500 V _{pk}
Max. mains-side overcurrent protection	Not needed	Not needed	Not needed
Approvals	UL, CSA	UL, CSA	UL, CSA
Remote status contact	Floating (dry), Form C (SPDT)	Floating (dry), Form C (SPDT)	Floating (dry), Form C (SPDT)



Protection module for DEHNgard® M UL series

- High discharge capacity due to heavy-duty zinc oxide varistors (I_{max} 50 kA 8x 20 μs)
- ANSI/UL 1449 – 4th Ed. Open-Type 1 SPD
- High reliability due to “Thermo Dynamic Control” SPD monitoring device

DEHNgard PLU ... : Varistor-based protection module for DEHNgard SU/MU ... surge arresters

The varistor based protection modules of the DEHNgard SU/MU ... surge arresters distinguish themselves through their outstanding performance and sophistication.

The compact protection modules incorporate the complete protective circuit as well as the monitoring and disconnection device. The green flag in the inspection window indicates the availability of the protection modules. All protection modules are mechanically coded to ensure against installing an incorrect module. The protection modules can be easily replaced without tools by simply pressing the user-friendly module release button.

Varistor-Based Protection Module

Varistor-based protection module for DEHNgard MU ... and DEHNgard SU ... surge arresters.

Type DG PLU ...	180	230	275	385	510	550
Part No.	908 011	908 012	908 010	908 014	908 013	908 015
Nominal discharge current (8/20 μs) (I _n)	20 kA	20 kA	20 kA	20 kA	20 kA	20 kA
Max. discharge current (I _{max})	50 kA	50 kA	50 kA	50 kA	50 kA	50 kA





SPD+POP+MCB / POP+MCB

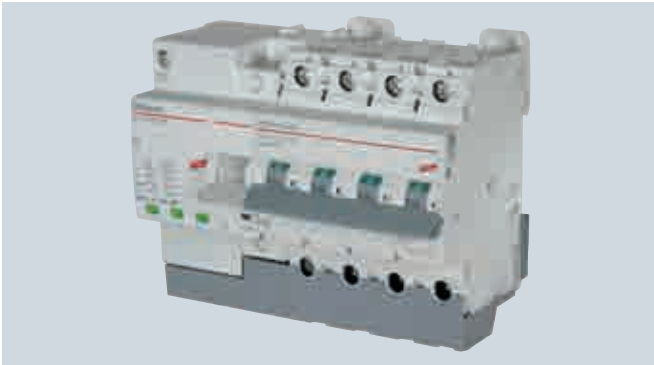

For protecting low-voltage consumer's installations against transient and temporary overvoltages (SPD+POP). For installation in conformity with the lightning protection zone concept at the boundaries from $O_B - 1$ and higher.

- Comprehensive protection against transient and power frequency overvoltage (SPD+POP)
- Fulfils the requirements of EN 50550 "Power frequency overvoltage protective device"
- **Prewired complete unit, individual devices do not have to be additionally wired**
- **Easy installation and retrofitting thanks to low space requirements** High reliability due to "Thermo Dynamic Control" monitoring system integrated in the SPD
- Application-optimised discharge capacity of 5 kA (I_n) / 15 kA (I_{max}) (8/20 μ s) per pole
- **Energy coordination with other arresters of the Red/Line series**
Operating state / fault indication by green / red indicator flag in the inspection window of the SPD

SPD+POP 2 255 C... : Compact surge arrester for transient and power frequency overvoltages in single-phase TT and TN systems ("1+1" circuit)

SPD+POP 4 255 C... : Compact surge arrester for transient and power frequency overvoltages in TT and TN systems ("3+1" circuits)

POP 2 255 C... : Compact surge protective device for power frequency overvoltages in single-phase TT and TN systems

POP 4 255 C... : Compact surge protective device for power frequency overvoltages in single-phase TT and TN-S systems

Electrical installations are increasingly damaged by overvoltage. This damage is not only caused by transient overvoltages, but also by power frequency overvoltages which result from e.g. instable systems or breakage of the neutral conductor.

The compact SPD+POP 2/4 255 C.. surge protective devices combine conventional surge protection (SPD) with power frequency overvoltage protection (POP) in an easy-to-install complete device.

The type 2 arresters ensure protection against transient overvoltages caused by e.g. inductive coupling resulting from a lightning strike or switching operations. The devices fully comply with the requirements of national and international product standards and feature a dual Thermo Dynamic Control monitoring device which ensures maximum reliability.

The POP 2/4 255 C.. surge protective devices can be used in installations which are already protected against transient overvoltage by other meas-

ures and comply with the European EN 50550 product standard for "Power frequency overvoltage protective devices".

If power frequency overvoltages occur, the connected miniature circuit breaker (MCB) disconnects the arresters, putting them into a safe state. When the miniature circuit breaker is reconnected, the system is checked for surges. If the system is still unstable and unbalanced surges are present, the miniature circuit breaker trips again.

Various types are available for different tripping currents of the miniature circuit breaker. This ensures that the surge protective device is suitable for the parameters of the electrical installation.

Despite of the manifold functions, the devices take up little space: Four to seven modules are required for protecting an electrical installation. Therefore, the devices can be easily retrofitted into existing electrical installations.

Surge Arresters – Type 2

Two-pole SPD+POP+MCB

Type SPD+POP ...	2 255 C25	2 255 C32	2 255 C40
Part No.	900 780	900 781	900 782
SPD+POP+MCB			
Number of poles	1P + N	1P + N	1P + N
Nominal a.c. voltage (U_N)	230 V	230 V	230 V
SPD			
Nominal discharge current (8/20 μ s) [L-N] (I_n)	5 kA	5 kA	5 kA
MCB			
Tripping characteristic	C	C	C
Nominal alternating current (I_n)	25 A	32 A	40 A



Four-pole SPD+POP+MCB

Type SPD+POP ...	4 255 C25	4 255 C32	4 255 C40	4 255 C63
Part No.	900 785	900 786	900 787	900 788
SPD+POP+MCB				
Number of poles	3P + N	3P + N	3P + N	3P + N
Nominal a.c. voltage (U_N)	230 / 400 V	230 / 400 V	230 / 400 V	230 / 400 V
SPD				
Nominal discharge current (8/20) [L-N] (I_n)	5 kA	5 kA	5 kA	5 kA
MCB				
Tripping characteristic	C	C	C	C
Nominal alternating current (I_n)	25 A	32 A	40 A	63 A



Two-pole POP+MCB

Type POP ...	2 255 C25	2 255 C32	2 255 C40
Part No.	900 760	900 761	900 762
POP+MCB			
Number of poles	1P + N	1P + N	1P + N
Nominal a.c. voltage (U_N)	230 V	230 V	230 V
MCB			
Tripping characteristic	C	C	C
Nominal alternating current (I_n)	25 A	32 A	40 A



Four-pole POP+MCB

Type POP ...	4 255 C25	4 255 C32	4 255 C40	4 255 C63
Part No.	900 765	900 766	900 767	900 768
POP+MCB				
Number of poles	3P + N	3P + N	3P + N	3P + N
Nominal a.c. voltage (U_N)	230 / 400 V	230 / 400 V	230 / 400 V	230 / 400 V
MCB				
Tripping characteristic	C	C	C	C
Nominal alternating current (I_n)	25 A	32 A	40 A	63 A





DEHNCord

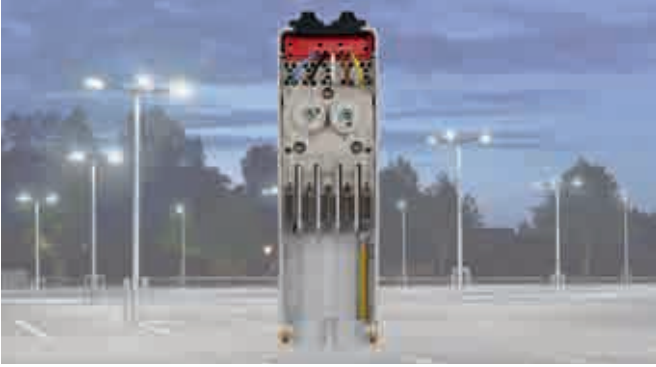

For protecting electronic devices (e.g. LED lights) from surges. For flexible installation in electrical installation systems such as flush-type boxes, flush-mounted systems, cable ducts and wall boxes. For installation in conformity with the lightning protection zone concept at the boundaries from $O_B - 1$ and higher.

Flexible surge protection

- Single-pole, two-pole or three-pole surge protective device with monitoring system and disconnector
- Visual fault indication
- Types with disconnection of the load circuit in the event of a fault and protection of the control phase
- Compact design also for outdoor use
- Can be fitted in junction boxes, flush-mounted systems, cable ducts and flush-type boxes

- DEHNCord L 1P ...: Compact single-pole version; for use in flush-type boxes, flush-mounted systems and cable ducts
 DEHNCord L 2P ...: Compact two-pole version; for use in flush-type boxes, flush-mounted systems and cable ducts
 DEHNCord L 3P ... SO LTG: Compact three-pole version; for use in the junction boxes of LED light poles with disconnection of the load circuit in the event of a fault and protection of the control phase
 DEHNCord R 3P ...: Compact three-pole version; for use with electric shutters and blinds

The DEHNCord series can be flexibly used as type 2 surge arrester, thus offering a variety of different application options. Compact in design, the surge arresters are ideally suited for protecting electrical and electronic loads in final circuits wherever the performance of a standard type 3 surge protective device for terminal equipment reaches its limits. An important field of application is the protection of outdoor LED lights. This can be achieved by the DEHNCord L ... SO LTG type which can be integrated in the junction box of an LED light pole. This device additionally allows a control phase to be protected and the load circuit to be interrupted if the DEHNCord arrester is faulty. This makes it considerably easier to detect faults, thus facilitating testing and maintenance of the system. DEHNCord is classed a type 2 surge arrester and can therefore be installed according to the lightning protection zones concept at the transition from $O_B - 1$ and higher. This ensures proper installation of surge protective devices wherever space is restricted. Despite the powerful protective circuit, the compact enclosure of the DEHNCord devices also houses a disconnector and a visual operating state/fault indicator. Be it in junction boxes, cable ducts, flush-mounted systems, junction boxes or device casings: There is always enough space for DEHNCord in the relevant installation environment.

Cost-effective, compact type for two LED. One DCOR for an optimal surge protection of two LED lamps.



Thanks to its adapted design, the LTG type is ideally suited for integration in the upper area of the EK480 junction box (fuse box) from Langmatz.

The IP type can both be integrated in junction boxes and directly in the mast (cables can be entered into any junction box (fuse box) thanks to IP 65 degree of protection).

The multipole DEHNCord R 3P adapter is a type 2 surge arrester with monitoring device and disconnector for installation in the connection cable of the motor of electric blinds or shutters to protect them and building installation against surge induced on the building facade.

By installing this device you meet the requirements of the lightning protection zone concept as well as installation standard for buildings IEC 60364-4-44/-5-53 (DIN VDE 0100-443/-534.S).

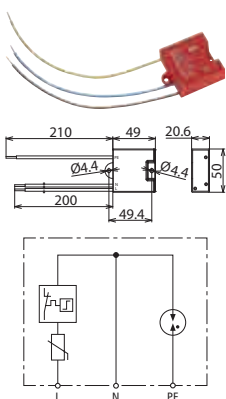

DEHNCord L 2P

Two-pole surge arrester for all installation systems (1+1 configuration); compact design.

Type DCOR ...	L 2P 275	L 2P 320
Part No.	900 430	900 432
SPD according to EN 61643-11 / IEC 61643-11	type 2 / class II	type 2 / class II
Max. continuous operating voltage (a.c.) [L-N] (U_C)	275 V (50 / 60 Hz)	320 V (50 / 60 Hz)
Nominal discharge current (8/20 μ s) (I_n)	5 kA	5 kA
Max. discharge current (8/20 μ s) (I_{max})	10 kA	10 kA
Voltage protection level [L-N] (U_P)	≤ 1.5 kV	≤ 1.75 kV
Voltage protection level [N-PE] (U_P)	≤ 1.5 kV	≤ 1.5 kV
Max. mains-side overcurrent protection	25 A gG	25 A gG
Approvals	KEMA	KEMA

Surge Arresters – Type 2

DEHncord L 1P

Single-pole surge arrester for all installation systems; compact design.

Type DCOR ...	L 1P 275	L 1P 320
Part No.	900 431	900 433
SPD according to EN 61643-11 / IEC 61643-11	type 2 / class II	type 2 / class II
Max. continuous operating voltage (a.c.) [L-N] (U_c)	275 V (50 / 60 Hz)	320 V (50 / 60 Hz)
Nominal discharge current (8/20 μ s) (I_n)	5 kA	5 kA
Max. discharge current (8/20 μ s) (I_{max})	10 kA	10 kA
Voltage protection level [L-N] (U_p)	≤ 1.5 kV	≤ 1.75 kV
Max. mains-side overcurrent protection	25 A gG	25 A gG
Approvals	KEMA	KEMA

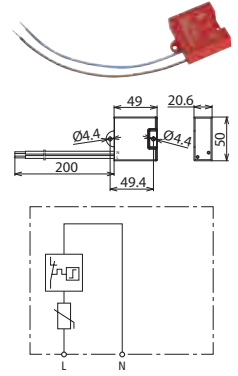

DEHncord L 3P 275 SO LTG

Three-pole surge arrester for all installation systems; compact design.

Type DCOR ...	L 3P 275 SO LTG
Part No.	900 445
SPD according to EN 61643-11 / IEC 61643-11	type 2 / class II
Max. continuous operating voltage (a.c.) [L-N] (U_c)	275 V (50 / 60 Hz)
Nominal discharge current (8/20 μ s) (I_n)	5 kA
Max. discharge current (8/20 μ s) (I_{max})	10 kA
Voltage protection level [L-N] (U_p)	≤ 1.5 kV
Voltage protection level [N-PE] (U_p)	≤ 1.5 kV
Max. mains-side overcurrent protection	B 16 A
Approvals	KEMA

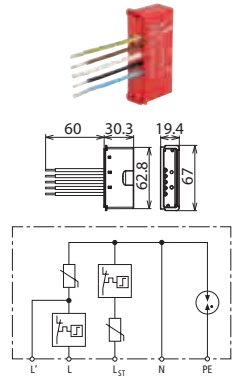

DEHncord L 2P 275 SO LTG

Two-pole surge arrester for all installation systems; compact design.

Type DCOR ...	L 2P 275 SO LTG
Part No.	900 446
SPD according to EN 61643-11 / IEC 61643-11	type 2 / class II
Max. continuous operating voltage (a.c.) [L-N] (U_c)	275 V (50 / 60 Hz)
Nominal discharge current (8/20 μ s) (I_n)	5 kA
Max. discharge current (8/20 μ s) (I_{max})	10 kA
Voltage protection level [L-N] (U_p)	≤ 1.5 kV
Voltage protection level [N-PE] (U_p)	≤ 1.5 kV
Max. mains-side overcurrent protection	B 16 A
Approvals	KEMA

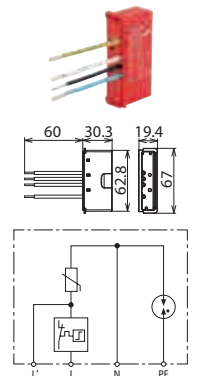

DEHncord L 2P SN1860

Two-pole surge arrester for all installation systems; compact design.

Type DCOR ...	L 2P SN1860
Part No.	999 937
SPD according to EN 61643-11 / IEC 61643-11	type 2 / class II
Max. continuous operating voltage (a.c.) [L-N] (U_c)	275 V (50 / 60 Hz)
Nominal discharge current (8/20 μ s) (I_n)	5 kA
Max. discharge current (8/20 μ s) (I_{max})	10 kA
Voltage protection level [L-N] (U_p)	≤ 1.5 kV
Voltage protection level [N-PE] (U_p)	≤ 1.5 kV
Max. mains-side overcurrent protection	B 16 A

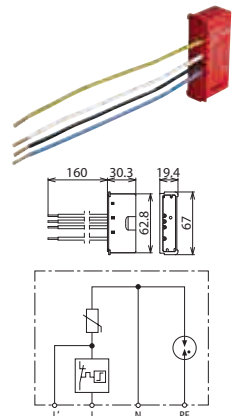

DEHncord L 2P 275 SO LT

Two-pole surge arrester for all installation systems; compact design.

Type DCOR ...	L 2P 275 SO LT
Part No.	900 435
SPD according to EN 61643-11 / IEC 61643-11	type 2 / class II
Max. continuous operating voltage (a.c.) [L-PEN] (U_c)	275 V (50 / 60 Hz)
Nominal discharge current (8/20 μ s) (I_n)	5 kA
Max. discharge current (8/20 μ s) (I_{max})	10 kA
Voltage protection level [L-PEN] (U_p)	≤ 1.5 kV
Max. mains-side overcurrent protection	B 16 A
Approvals	KEMA

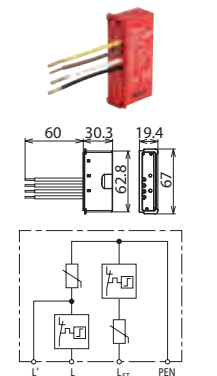

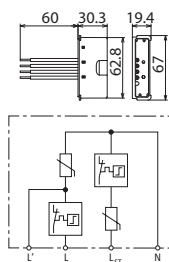

DEHNcord L 2P SN1864

Surge arrester for all installation systems; compact design.

Type DCOR ...	L 2P SN1864
Part No.	999 906 <small>NEW</small>
SPD according to EN 61643-11 / IEC 61643-11	type 2 / class II
Max. continuous operating voltage (a.c.) [L-N] (U_c)	275 V (50 / 60 Hz)
Nominal discharge current (8/20 μ s) (I_n)	5 kA
Max. discharge current (8/20 μ s) (I_{max})	10 kA
Voltage protection level [L-N] (U_p)	≤ 1.5 kV
Max. mains-side overcurrent protection	B 16 A

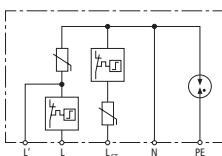
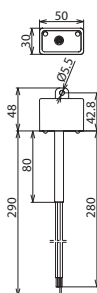

DEHNcord L 3P 275 SO IP

Three-pole surge arrester for all installation systems; compact design. IP 65 degree of protection.

Type DCOR ...	L 3P 275 SO IP
Part No.	900 447
SPD according to EN 61643-11 / IEC 61643-11	type 2 / class II
Max. continuous operating voltage (a.c.) [L-N] (U_c)	275 V (50 / 60 Hz)
Nominal discharge current (8/20 μ s) (I_n)	5 kA
Max. discharge current (8/20 μ s) (I_{max})	10 kA
Voltage protection level [L-N] (U_p)	≤ 1.5 kV
Voltage protection level [N-PE] (U_p)	≤ 1.5 kV
Max. mains-side overcurrent protection	B 16 A

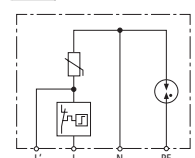
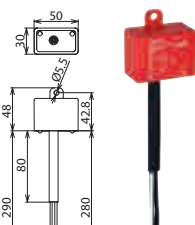

DEHNcord L 2P 275 SO IP

Two-pole surge arrester for all installation systems; compact design. IP 65 degree of protection.

Type DCOR ...	L 2P 275 SO IP
Part No.	900 448
SPD according to EN 61643-11 / IEC 61643-11	type 2 / class II
Max. continuous operating voltage (a.c.) [L-N] (U_c)	275 V (50 / 60 Hz)
Nominal discharge current (8/20 μ s) (I_n)	5 kA
Max. discharge current (8/20 μ s) (I_{max})	10 kA
Voltage protection level [L-N] (U_p)	≤ 1.5 kV
Voltage protection level [N-PE] (U_p)	≤ 1.5 kV
Max. mains-side overcurrent protection	B 16 A

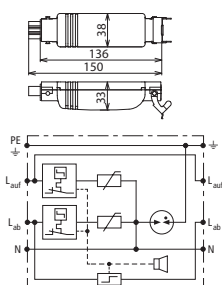

DEHNcord R 3P

Surge arrester for electric Venetian blinds; compact dimensions.

Type DCOR ...	R 3P 275
Part No.	900 449 <small>NEW</small>
SPD according to EN 61643-11 / IEC 61643-11	type 2 / class II
Max. continuous operating voltage (a.c.) [L-N] (U_c)	275 V (50 / 60 Hz)
Nominal discharge current (8/20 μ s) (I_n)	2.5 kA
Max. discharge current (8/20 μ s) (I_{max})	5 kA
Voltage protection level [L-N] (U_p)	≤ 1.5 kV
Connector	Hirschmann STAK 3 / STAS 3



DEHNgap C S

N-PE surge arrester

- Specifically designed for use in 3+1 and 1+1 configurations of TT systems acc. to IEC 60364-5-53 between neutral conductor N and protective conductor PE
- High discharge capacity
- Two-part surge arrester consisting of a base part and a plug-gable spark-gap-based protection module
- Energy coordination with other arresters of the Red/Line product family
- Operating state/fault indication by green/red indicator flag in the inspection window
- With remote signalling contact for monitoring device
- Easy replacement of protection modules without tools due to module locking system with module release button
- Vibration and shock-tested according to EN 60068-2



For protecting low-voltage consumer's installations against surges. For installation in conformity with the lightning protection zone concept at the boundaries from $O_B - 1$ and higher.

DEHNgap C S: N-PE surge arrester consisting of a base part and a plug-in protection module

DEHNgap C S FM: With remote signalling contact for monitoring device (floating changeover contact)

The N-PE surge arresters of type DEHNgap C S are an ideal supplement to the single-pole DEHNgard S surge protective devices. Being total current arresters between the neutral and protective conductor in TT systems, DEHNgap C S surge arresters help to ensure fulfilling the requirements for protecting personnel and equipment in 3+1 and 1+1 configurations.

With their modern Red/Line design, DEHNgap C S surge arresters have exactly the same easy-to-use safety features as the DEHNgard S devices. The unique module locking system combines the spark-gap-based protection module and the base part to a powerful unit. Neither vibration during transport nor the enormous forces of discharge can loosen this connection. Nevertheless, the protection modules can be easily replaced without tools by simply pressing the easy-to-use module release button of the protection module. The mechanical coding of the protection module and base part ensures against installing an incorrect module.

Safety of DEHNgap C S surge arresters is increased by monitoring the arrester temperature and an integrated disconnecter connected in series with the surge arrester.

The green and red indicator flags show the operating state of DEHNgap C S surge arresters.

Apart from this standard visual indication, DEHNgap C S ... FM features a three-pole remote signalling terminal. With its floating changeover contact, the remote signal can be used as a break or make contact according to the particular circuit concept. The N-PE surge arresters of type DEHNgap C S incorporate multifunctional terminals for connecting conductors and busbars, allowing easy wiring with other DIN rail mounted devices. Thus, a variety of applications can be easily connected in series according to IEC 60364-5-53 for optimal protection.

DEHNgap C S (FM)

N-PE surge arrester; FM version with floating remote signalling contact.

Type DGP C ...	S	S FM
Part No.	952 030	952 035
SPD according to EN 61643-11 / IEC 61643-11	type 2 / class II	type 2 / class II
Max. continuous operating voltage (a.c.) (U_C)	255 V (50 / 60 Hz)	255 V (50 / 60 Hz)
Nominal discharge current (8/20 μ s) (I_n)	20 kA	20 kA
Max. discharge current (8/20 μ s) (I_{max})	40 kA	40 kA
Voltage protection level (U_P)	≤ 1.5 kV	≤ 1.5 kV
Approvals	KEMA, VDE, UL	KEMA, VDE, UL
Type of remote signalling contact	—	changeover contact



Accessories for DEHNgap C S

N-PE Spark-Gap-Based Protection Module for DEHNgap C S

N-PE spark-gap-based protection module for single-pole N-PE surge arresters of type DEHNgap DGP C S ...

Type	DGP C MOD
Part No.	952 060
Max. continuous operating voltage (a.c.) (U_C)	255 V



DEHNgard® SE DC ... (FM)



For protecting low-voltage consumer's installations against surges. For installation in conformity with the lightning protection zone concept at the boundaries from $O_B - 1$ and higher.

DEHNgard SE DC ...: Modular single-pole surge arrester for d.c. applications
DEHNgard SE DC ... FM: With remote signalling contact for monitoring device (floating changeover contact)

The modular devices of the DEHNgard SE DC product series are coordinated single-pole type 2 surge arresters with a functional design.

When developing this device series for protecting d.c. systems, the main focus was on the increased requirements of d.c. applications with regard to device safety in all operating states. The extremely powerful d.c. switching device DCD, which prevents fire damage caused by switching arcs, is the core of the DEHNgard SE DC devices.

DEHNgard SE DC ... (FM) is coordinated with DEHNsecure ... (FM) type 1 lightning current arresters (minimum decoupling length of 1 m must be observed).

The DEHNgard SE DC devices combine high performance and ease of use in a single device. Their electrical parameters are rated for the most stringent requirements within lightning and surge protection systems. The high number of features shows that the main focus is both on reliable surge protection and device safety.

Proven heavy-duty varistors are used to discharge high impulse currents and limit the destructive surge impulses to the specified voltage protection level values. The operating state of the arrester is permanently monitored via the surface temperature of the heavy-duty varistor and the d.c. switching device DCD is immediately activated in case of overload. The mechanical visual indicator with green and red indicator flags, which is available for each protective path, is directly connected to the d.c. switching device DCD. When the red indication appears in the inspection win-

Modular single-pole surge arrester for d.c. applications

- Universal single-pole surge arrester consisting of a base part and a plug-in protection module
- Device concept specifically developed for use in d.c. circuits
- Powerful d.c. switching device DCD prevents fire damage caused by d.c. switching arcs
- Use without additional backup fuse in defined applications
- Operating state/fault indication by green/red indicator flag in the inspection window
- Easy replacement of protection modules without tools due to module locking system with module release button

dow, the d.c. switching device DCD has already safely interrupted the d.c. switching arc and thus reliably prevented fire damage. In case of the DEHNgard SE DC ... FM version, the arrester status can be additionally indicated via a three-pole remote signalling terminal.

The special design of the d.c. switching device DCD even ensures a short-circuit withstand capability up to 300 A d.c. – without arrester backup fuse (!). In combination with the specified backup fuses, the short-circuit withstand capability can be even increased to 25,000 A d.c., which is certainly an innovation in the field of d.c. applications.

The single-pole devices are available for voltages from 60 V to 900 V d.c. and can thus be used for a variety of applications such as emergency power supply systems, d.c. systems for direct supply of d.c. drives, control circuits and battery-operated supply systems of any kind.

To implement these numerous features, the devices incorporate the modular Red/Line family design with a width of 1.5 modules. The mechanical design of the connection points is another safety feature. The covered screws provide additional shock protection and the projections for easily and safely entering the cable increase clearances and creepage distances so that no distance to other equipment must be maintained even in case of voltages up to 900 V d.c.

The coded plug-in protection modules ensure a high degree of protection. Consequently, damage caused by installing an incorrect module can be virtually excluded.

Surge Arresters – Type 2

DEHNgard SE DC ...

Modular single-pole surge arrester for d.c. applications.

Type DG SE DC ...	60	242	550	900
Part No.	972 110	972 120	972 130	972 140
SPD according to EN 61643-11 / IEC 61643-11	type 2 / class II	type 2 / class II	type 2 / class II	type 2 / class II
Max. continuous operating voltage (d.c.) (U_c)	60 V	242 V	550 V	900 V
Nominal discharge current (8/20 μ s) (I_n)	12.5 kA	12.5 kA	12.5 kA	12.5 kA
Voltage protection level (U_p)	≤ 0.5 kV	≤ 1.25 kV	≤ 2.0 kV	≤ 3.0 kV
Short-circuit withstand capability without backup fuse (d.c.) (I_{SCCR})	300 A	300 A	200 A	100 A
Short-circuit withstand capability for max. mains-side overcurrent protection (d.c.) (I_{SCCR})	25 kA	25 kA	25 kA	25 kA
Max. mains-side overcurrent protection	35 A gG	35 A gG	35 A gG	80 A gPV



DEHNgard SE DC ... FM

Modular single-pole surge arrester for d.c. applications; with floating remote signalling contact.

Type DG SE DC ...	60 FM	242 FM	550 FM	900 FM
Part No.	972 115	972 125	972 135	972 145
SPD according to EN 61643-11 / IEC 61643-11	type 2 / class II	type 2 / class II	type 2 / class II	type 2 / class II
Max. continuous operating voltage (d.c.) (U_c)	60 V	242 V	550 V	900 V
Nominal discharge current (8/20 μ s) (I_n)	12.5 kA	12.5 kA	12.5 kA	12.5 kA
Voltage protection level (U_p)	≤ 0.5 kV	≤ 1.25 kV	≤ 2.0 kV	≤ 3.0 kV
Short-circuit withstand capability without backup fuse (d.c.) (I_{SCCR})	300 A	300 A	200 A	100 A
Short-circuit withstand capability for max. mains-side overcurrent protection (d.c.) (I_{SCCR})	25 kA	25 kA	25 kA	25 kA
Max. mains-side overcurrent protection	35 A gG	35 A gG	35 A gG	80 A gPV
Type of remote signalling contact	changeover contact	changeover contact	changeover contact	changeover contact



Accessories for DEHNgard® SE DC ... (FM)

Varistor-based Protection Module for DEHNgard SE DC

Varistor-based protection module for DEHNgard SE DC

Type DG MOD ...	E DC 60	E DC 242	E DC 550	E DC 900
Part No.	972 010	972 020	972 030	972 040
Max. continuous operating voltage (d.c.) (U_c)	60 V	242 V	550 V	900 V



Earthing Clip for 1.5-module Enclosures, single-phase, two-pole

Earthing clip for connecting the earth terminal of e.g. two SPDs with 1.5-module enclosure to earth, with terminal.

Type	EB 1 2 1.5
Part No.	900 460
Dimensions	34 x 60 x 28 mm
Terminal	up to 25 mm ²





DEHNgard® modular YPV ... FM



For protecting low-voltage consumer's installations against surges. For use in accordance with IEC 60364-7-712 (installation of photovoltaic power supply systems).

Multipole photovoltaic arresters

- Modular prewired complete unit for photovoltaic systems consisting of a base part and plug-in protection modules
- Fault-resistant Y circuit with three high-capacity varistors prevents damage to the surge protective device in case of insulation faults in the generator circuit
- Tested to EN 50539-11
- High monitoring safety due to "Thermo Dynamic Control" disconnecting device
- Fault indication by red indicator flag in the inspection window
- Suitable for use in accordance with IEC 60364-7-712 "Electrical installations of buildings – Solar voltaic (PV) power supply systems"

DEHNgard M YPV 1200 FM: For PV systems up to 1170 V, with remote signalling contact for monitoring device (floating changeover contact)
DEHNgard M YPV 1500 FM: For PV systems up to 1500 V, with remote signalling contact for monitoring device (floating changeover contact)

The modular DEHNgard modular YPV SCI ... FM surge arresters are specifically designed for protecting equipment in photovoltaic systems. The devices are available for 1200 V and 1500 V and cover the most common voltage levels.

The following application features characterise the modular arrester design of this Red/Line product series. The module locking system firmly fixes the protection modules to the base part. Neither shock nor vibration nor the enormous forces of discharge affect the safe connection to the protection module. Nevertheless, the protection modules can be easily replaced without tools by simply pressing the easy-to-use module release button of the protection modules. Every protective path of DEHNgard modular YPV SCI ... FM and every protection module is mechanically coded to ensure against installing the incorrect module.

The fault-resistant Y circuit with three high-capacity varistors prevents damage to surge protective devices in case of insulations faults in the generator circuit of the photovoltaic generator.

The green and red indicator flags show the availability of every protective circuit. Apart from this visual indication, DEHNgard YPV ... FM arresters also feature a three-pole remote signalling terminal. With its floating changeover contact, the remote signal can be used as make or break contact according to the particular circuit concept. As with all surge arresters of the modular DEHNgard modular family, DEHNgard modular YPV ... FM arresters incorporate multifunctional terminals on a standardised spacing of 1 module for connecting conductors and busbars, allowing easy wiring with other DIN rail mounted devices.

DEHNgard M YPV ... FM

Modular multipole surge arrester for PV systems with remote signalling contact for monitoring device (floating changeover contact).



Type DG M YPV ...	1200 FM	1500 FM
Part No.	952 565 ^{NEW}	952 567 ^{NEW}
SPD according to EN 50539-11	type 2	type 2
Max. PV voltage (U_{CPV})	1170 V	1500 V
Short-circuit current rating (I_{SCP})	10 kA	10 kA
Nominal discharge current (8/20 μ s) [(DC+/DC-) --> PE] (I_n)	20 kA	15 kA
Max. discharge current (8/20 μ s) [(DC+/DC-) --> PE] (I_{max})	40 kA	40 kA
Voltage protection level (U_P)	≤ 4 kV	≤ 5 kV
Approvals	UL, KEMA	UL, KEMA
Type of remote signalling contact	changeover contact	changeover contact

Accessories for DEHNgard® modular YPV ... FM



Varistor-Based Protection Module for DEHNgard M YPV

Type	DG MOD H PV 600	DG MOD H PV 750
Part No.	952 048 ^{NEW}	952 049 ^{NEW}
Max. continuous operating voltage (d.c.) (U_c)	600 V	750 V

DEHNgard® modular (Y)PV SCI ...**Multipole / single-pole PV Arresters with three-step d.c. Switching Device**

- Prewired modular complete unit for use in photovoltaic systems consisting of a base part and plug-in protection modules
- Combined disconnection and short-circuiting device with safe electrical isolation in the protection module (patented SCI principle)
- Tried and tested fault-resistant Y circuit of DEHNgard M YPV SCI ... (FM) prevents damage to the surge protective device in case of insulation faults in the generator circuit
- Integrated d.c. fuse allows safe replacement of protection modules without arc formation
- Tested to EN 50539-11
- Suitable for use in all PV systems according to IEC 60364-7-712



For protecting low-voltage consumer's installations against surges. For use in accordance with IEC 60364-7-712 (installation of photovoltaic power supply systems).

DEHNgard M YPV SCI 150:	Modular multipole surge arrester with three-step d.c. switching device; for photovoltaic systems up to 150 V
DEHNgard M YPV SCI 600:	For photovoltaic systems up to 600 V
DEHNgard M YPV SCI 1000:	For photovoltaic systems up to 1000 V
DEHNgard M PV2 SCI 1000:	For photovoltaic systems up to 1000 V; for protecting two MPP inputs
DEHNgard M YPV SCI 1200:	For photovoltaic systems up to 1200 V
DEHNgard M YPV SCI ... FM:	With remote signalling contact for monitoring device (floating changeover contact)
DEHNgard S PV SCI 150:	For photovoltaic systems up to 150 V solidly earthed on the d.c. side
DEHNgard S PV SCI 600:	For photovoltaic systems up to 600 V solidly earthed on the d.c. side
DEHNgard S PV SCI ... FM:	With remote signalling contact for monitoring device (floating changeover contact)

The modular DEHNgard modular (Y)PV SCI ... (FM) surge arresters are specifically designed for protecting equipment in photovoltaic systems. The patented three-step d.c. switching device (SCI principle) makes these arresters especially safe so that they fulfil the requirements in modern photovoltaic systems. The devices are available for 150 V, 600 V, 1000 V and 1200 V applications. DEHNgard ME YPV SCI 1500 (FM) – a 1500 V version – covers the most common voltage levels. DEHNgard M PV2 SCI ... also provides protection for 2 MPP inputs in a single device.

The application features of the modular Red/Line family design are similarly unique as the three-step d.c. switching device. The module locking system firmly fixes the protection modules to the base part. Neither shock nor vibration nor the enormous forces of discharge affect the safe connection to the protection module. Nevertheless, the protection modules can be easily replaced without tools by simply pressing the easy-to-use module release button of the protection modules. Every protective path of DEHNgard modular (Y)PV SCI ... (FM) and every protection module is mechanically coded to ensure against installing the incorrect module.

To fulfil the special requirements in photovoltaic systems, a fault-resistant Y circuit consisting of three protective paths of the varistor and a combined disconnection and short-circuiting device are integrated in a single device.

This synergy reduces the probability of an arrester failure in case of the operating and fault states which have to be considered in photovoltaic systems. This ensures that the arrester is protected in case of overload. Even in case of voltages up to 1200 V d.c., a switching arc, which is likely to occur in the surge protective device if a conventional disconnector (for a.c. application) is activated, is extinguished immediately without risk.

A fuse particularly developed for photovoltaic systems is integrated in the short-circuit path. This ensures safe electrical isolation in case of a faulty protection module, allowing de-energised replacement of the protection module without arc formation. This innovative and unique design,

DEHNgard modular (Y)PV SCI ... (FM) can be used in all low, medium and high-performance photovoltaic systems with no need for an additional backup fuse.

DG S PV SCI ... (FM) arresters are specifically designed for PV systems solidly earthed on the d.c. side. Since either the positive or the negative pole of the PV generator is solidly earthed, the space-saving and thus cost-effective DG S PV SCI ... (FM) arresters can be used where one protection module has been removed from the Y circuit.

The green and red indicator flags show the availability of every protective circuit. Apart from this visual indication, DEHNgard (Y)PV SCI ... (FM) arresters also feature a three-pole remote signalling terminal. With its floating changeover contact, the remote signal can be used as make or break contact according to the particular circuit concept. As with all surge arresters of the modular DEHNgard modular family, DEHNgard modular (Y)PV SCI ... (FM) arresters incorporate multifunctional terminals on a standardised spacing of 1 module for connecting conductors and busbars, allowing easy wiring with other DIN rail mounted devices.

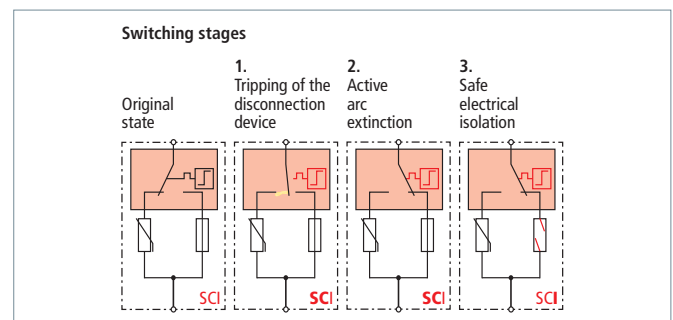

Three-step d.c. switching device (patented SCI principle)

DEHNgard M YPV SCI ...

Modular multipole surge arrester with three-step d.c. switching device for use in PV systems



Type DG ...	M YPV SCI 150	M YPV SCI 600	M YPV SCI 1000	M YPV SCI 1200
Part No.	952 513	952 511	952 510	952 512
SPD according to EN 50539-11	type 2	type 2	type 2	type 2
Max. PV voltage (U_{CPV})	150 V	600 V	1000 V	1200 V
Short-circuit current rating (I_{SCPV})	10 kA	10 kA	10 kA	10 kA
Nominal discharge current (8/20 μ s) [(DC+/DC-) --> PE] (I_n)	10 kA	12.5 kA	12.5 kA	12.5 kA
Max. discharge current (8/20 μ s) [(DC+/DC-) --> PE] (I_{max})	20 kA	25 kA	25 kA	25 kA
Voltage protection level (U_p)	≤ 0.8 kV	≤ 2.5 kV	≤ 4 kV	≤ 4.5 kV
Approvals	KEMA, UL, CSA	KEMA, UL, CSA	KEMA, UL, CSA	KEMA, UL, CSA

DEHNgard M YPV SCI ... FM

Modular multipole surge arrester with three-step d.c. switching device for use in PV systems; with remote signalling contact for monitoring device (floating changeover contact).



Type DG ...	M YPV SCI 150 FM	M YPV SCI 600 FM	M YPV SCI 1000 FM	M YPV SCI 1200 FM
Part No.	952 518	952 516	952 515	952 517
SPD according to EN 50539-11	type 2	type 2	type 2	type 2
Max. PV voltage (U_{CPV})	150 V	600 V	1000 V	1200 V
Short-circuit current rating (I_{SCPV})	10 kA	10 kA	10 kA	10 kA
Nominal discharge current (8/20 μ s) [(DC+/DC-) --> PE] (I_n)	10 kA	12.5 kA	12.5 kA	12.5 kA
Max. discharge current (8/20 μ s) [(DC+/DC-) --> PE] (I_{max})	20 kA	25 kA	25 kA	25 kA
Voltage protection level (U_p)	≤ 0.8 kV	≤ 2.5 kV	≤ 4 kV	≤ 4.5 kV
Approvals	KEMA, UL, CSA	KEMA, UL, CSA	KEMA, UL, CSA	KEMA, UL, CSA
Type of remote signalling contact	changeover contact	changeover contact	changeover contact	changeover contact

DEHNgard S PV SCI ...

Modular single-pole surge arrester with three-step d.c. switching device for PV systems earthed on the d.c. side.



Type DG ...	S PV SCI 150	S PV SCI 600
Part No.	952 551	952 550
SPD according to EN 50539-11	type 2	type 2
Max. PV voltage (U_{CPV})	150 V	600 V
Short-circuit current rating (I_{SCPV})	10 kA	10 kA
Nominal discharge current (8/20 μ s) [(DC+/DC-) --> PE] (I_n)	10 kA	12.5 kA
Max. discharge current (8/20 μ s) [(DC+/DC-) --> PE] (I_{max})	20 kA	25 kA
Voltage protection level (U_p)	≤ 0.8 kV	≤ 2.5 kV
Approvals	KEMA, UL, CSA	KEMA, UL, CSA

DEHNgard S PV SCI ... FM

Modular single-pole surge arrester with three-step d.c. switching device for PV systems earthed on the d.c. side; with remote signalling contact for monitoring device (floating changeover contact).



Type DG ...	S PV SCI 150 FM	S PV SCI 600 FM
Part No.	952 556	952 555
SPD according to EN 50539-11	type 2	type 2
Max. PV voltage (U_{CPV})	150 V	600 V
Short-circuit current rating (I_{SCPV})	10 kA	10 kA
Nominal discharge current (8/20 μ s) [(DC+/DC-) --> PE] (I_n)	10 kA	12.5 kA
Max. discharge current (8/20 μ s) [(DC+/DC-) --> PE] (I_{max})	20 kA	25 kA
Voltage protection level (U_p)	≤ 0.8 kV	≤ 2.5 kV
Approvals	KEMA, UL, CSA	KEMA, UL, CSA
Type of remote signalling contact	changeover contact	changeover contact

Surge Arresters – Type 2 for PV Systems

DEHNgard M PV2 SCI ... (FM)

Modular multipole surge arrester with three-step d.c. switching device for protecting two MPP inputs; for use in PV systems up to 1000 V; FM version with floating remote signalling contact.

Type DG ...	M PV2 SCI 1000	M PV2 SCI 1000 FM
Part No.	952 514	952 519
SPD according to EN 50539-11	type 2	type 2
Max. PV voltage (U_{CPV})	1000 V	1000 V
Short-circuit current rating (I_{SCP})	10 kA	10 kA
Nominal discharge current (8/20 μ s) [(DC+/DC-) --> PE] (I_n)	12.5 kA	12.5 kA
Max. discharge current (8/20 μ s) [(DC+/DC-) --> PE] (I_{max})	25 kA	25 kA
Voltage protection level (U_P)	≤ 4 kV	≤ 4 kV
Approvals	UL, KEMA	UL, KEMA
Type of remote signalling contact	—	changeover contact



DEHNgard M SN1868

Modular multipole surge arrester with three-step d.c. switching device for protecting 3 MPP inputs; for PV systems with remote signalling contact for monitoring device (floating changeover contact).

Type DG ...	M PV2 SCI SN1868 FM
Part No.	999 799 ^{NEW}
SPD according to EN 50539-11	type 2
Max. PV voltage (U_{CPV})	1000 V
Short-circuit current rating (I_{SCP})	10 kA
Nominal discharge current (8/20 μ s) [(DC+/DC-) --> PE] (I_n)	12.5 kA
Max. discharge current (8/20 μ s) [(DC+/DC-) --> PE] (I_{max})	25 kA
Voltage protection level (U_P)	≤ 4 kV
Approvals	UL, KEMA
Type of remote signalling contact	changeover contact



Accessories for DEHNgard® modular (Y)PV SCI ...

Varistor-Based Protection Module for DEHNgard M (S) (Y)PV SCI

Protection module with integrated back-up fuse for DEHNgard M (Y)PV SCI ... arresters comprising a varistor connected in parallel with a short-circuiting device.

Type DG MOD ...	PV SCI 75	PV SCI 300	PV SCI 500	PV SCI 600
Part No.	952 055	952 053	952 051	952 054
Max. continuous operating voltage (d.c.) (U_c)	75 V	300 V	500 V	600 V



Varistor-Based Protection Module for DEHNgard M (S) (Y)PV SCI

Varistor-based protection module for DEHNgard M YPV SCI ... and DEHNgard S PV SCI ... arresters.

Type DG MOD ...	PV 75	PV 300	PV 500	PV 600
Part No.	952 045	952 043	952 041	952 044
Max. continuous operating voltage (d.c.) (U_c)	75 V	300 V	500 V	600 V



DEHNgard® modular E (Y)PV SCI 1500



For protecting low-voltage consumer's installations against surges. For use in accordance with IEC 60364-7-712 (installation of photovoltaic power supply systems).

Multipole/single-pole PV Arresters with three-step d.c. Switching Device

- Prewired modular complete unit for use in photovoltaic systems up to 1500 V consisting of a base part and plug-in protection modules
- Combined disconnection and short-circuiting device with safe electrical isolation in the protection module (patented SCI principle)
- New design for safe use in PV systems up to 1500 V
- Tested to EN 50539-11
- Suitable for use in all PV systems in accordance with IEC 60364-7-712

DEHNgard ME YPV SCI 1500: Modular multipole surge arrester with three-step d.c. switching device for PV systems up to 1500 V
DEHNgard SE PV SCI 1500: For PV systems up to 1500 V solidly earthed on the d.c. side
DEHNgard ME/SE (Y)PV SCI 1500 FM: With remote signalling contact for monitoring device (floating changeover contact)

The modular DEHNgard ME YPV SCI 1500 (FM) and DEHNgard SE PV SCI 1500 (FM) surge arresters are specifically designed for protecting equipment in photovoltaic systems up to 1500 V. The new design of these arresters of the DEHNgard ... SCI family meets the increased requirements regarding such a high voltage range; this is reflected in the increased width (1.5 modules), additional terminal covers and a special terminal slot. The patented three-step d.c. switching device (SCI principle) makes these arresters particularly safe so that they fulfil all requirements in modern photovoltaic systems. The devices are specifically designed for PV systems with high system voltages (up to 1500 V). As with DEHNgard modular (Y)PV SCI ... (FM) arresters, which are available as 150 V, 600 V, 1000 V and 1200 V versions, they cover the most common voltage levels.

The application features of the modular Red/Line family design are similarly unique as the three-step d.c. switching device. The module locking system firmly fixes the protection modules to the base part. Neither shock nor vibration nor the enormous forces of discharge affect the safe connection to the protection module. Nevertheless, the protection modules can be easily replaced without tools by simply pressing the easy-to-use module release button of the protection modules. Every protective path of DEHNgard modular E (Y)PV SCI 1500 (FM) and every protection module is mechanically coded to ensure against installing the incorrect module. To fulfil the special requirements in photovoltaic systems, a fault-resistant Y circuit consisting of three protective paths of the varistor and a combined disconnection and short-circuiting device are integrated in a single device.

This synergy further reduces the probability of an arrester failure in case of the operating and fault states which have to be considered in photovoltaic systems. This ensures that the arrester is protected in case of overload. Even in case of operating voltages up to 1500 V d.c., a switching arc, which is likely to occur when a conventional disconnector (for a.c. application) of a surge protective device is triggered, is extinguished immediately without risk.

DEHNgard SE PV SCI 1500 (FM) arresters are specifically designed for PV systems solidly earthed on the d.c. side; this type of earthing is meanwhile required e.g. by manufacturers of special thin-film modules or for legal or normative reasons in some regions.

Since either the positive or the negative pole of the PV generator is solidly earthed, the optimised DEHNgard SE PV SCI 1500 (FM) arresters (one protection module is removed from the Y circuit) may be used if the distance from the earthing point does not exceed 5 m.

The green and red indicator flags show the availability of every protective circuit. Apart from this visual indication, DEHNgard ME YPV SCI 1500 FM und DEHNgard SE PV SCI 1500 FM arresters also feature a three-pole remote signalling terminal. With its floating changeover contact, the remote signal can be used as make or break contact according to the particular circuit concept.

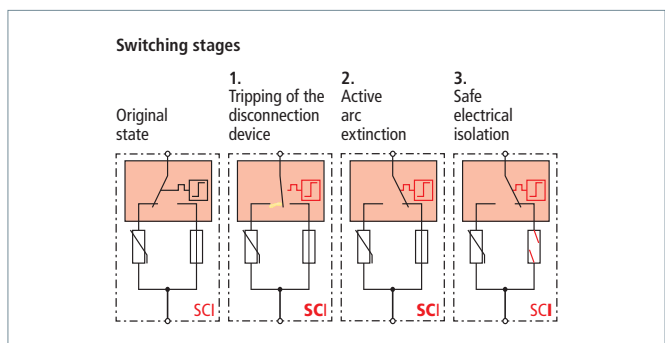

Three-step d.c. switching device (patented SCI principle)

Surge Arresters – Type 2 for PV Systems

DEHNgard ME YPV SCI 1500 (FM)

Modular multipole surge arrester with three-step d.c. switching device for PV systems.

Type DG ...	ME YPV SCI 1500	ME YPV SCI1500 FM
Part No.	952 520	952 525
SPD according to EN 50539-11	type 2	type 2
Max. PV voltage (U_{CPV})	1500 V	1500 V
Short-circuit current rating (I_{SCPV})	10 kA	10 kA
Total discharge current (8/20 μ s) (I_{total})	25 kA	25 kA
Nominal discharge current (8/20 μ s) [(DC+/DC-) --> PE] (I_n)	12.5 kA	12.5 kA
Voltage protection level (U_P)	≤ 6 kV	≤ 6 kV
Approvals	KEMA, UL	KEMA, UL
Type of remote signalling contact	—	changeover contact



DEHNgard SE PV SCI 1500 (FM)

Modular single-pole surge arrester with three-step d.c. switching device for PV systems earthed on the d.c. side; FM version with floating remote signalling contact.

Type DG ...	SE PV SCI 1500	SE PV SCI 1500 FM
Part No.	952 561	952 566
SPD according to EN 50539-11	type 2	type 2
Max. PV voltage (U_{CPV})	1500 V	1500 V
Short-circuit current rating (I_{SCPV})	10 kA	10 kA
Nominal discharge current (8/20 μ s) [(DC+/DC-) --> PE] (I_n)	12.5 kA	12.5 kA
Voltage protection level (U_P)	≤ 6 kV	≤ 6 kV
Approvals	KEMA, UL	KEMA, UL
Type of remote signalling contact	—	changeover contact



Accessories for DEHNgard® modular E (Y)PV SCI 1500

Varistor-Based Protection Module for DEHNgard ME YPV SCI and DEHNgard SE PV SCI

Varistor-based protection module for DEHNgard ME YPV SCI 1500 (FM) and DEHNgard SE PV SCI 1500 (FM)

Type	DG MOD E PV SCI 750
Part No.	952 056
Max. continuous operating voltage (d.c.) (U_c)	750 V



DEHNguard® YPV SCI ... – compact



For protecting low-voltage consumer's installations against surges. For use in accordance with IEC 60364-7-712 (installation of photovoltaic power supply systems).

Compact PV Arrester with three-step d.c. Switching Device

- Prewired complete unit for use in photovoltaic systems
- Combined disconnection and short-circuiting device with safe electrical isolation (patented SCI principle)
- Tried and tested fault-resistant Y circuit of DEHNguard YPV SCI ... prevents damage to the surge protective device in case of insulation faults in the generator circuit
- Tested to EN 50539-11
- Suitable for use in all PV systems according to IEC 60364-7-712

DEHNguard YPV SCI 600/1000: Multipole surge arrester with three-step d.c. switching device; for photovoltaic systems up to 600/1000 V
DEHNguard YPV SCI ... FM: With remote signalling contact for monitoring device (floating changeover contact)

The DEHNguard YPV SCI ... surge arresters are specifically designed for protecting equipment in photovoltaic systems. The patented three-step d.c. switching device (SCI principle) makes these arresters particularly safe so that they fulfil all requirements in modern photovoltaic systems. The devices are available as 600 V and 1000 V versions and cover the most common voltage levels for string inverter systems.

To fulfil the special requirements in photovoltaic systems, a fault-resistant Y circuit consisting of three protective paths of the varistor and a combined disconnection and short-circuiting device are integrated in a single device.

This synergy further reduces the probability of an arrester failure in case of the operating and fault states which have to be considered in photovoltaic systems. This ensures that the arrester is protected in case of overload. Even in case of voltages up to 1000 V d.c., a switching arc, which is likely to occur when a conventional disconnector (for a.c. application) of a surge protective device is triggered, is extinguished immediately without risk.

DEHNguard YPV SCI ... is a special cost-effective and application-optimised device which is particularly designed for string inverter systems with a limited system current up to 1000 A. The design includes the main device features without compromising safety.

The green and red indicator flags show the availability of every protective circuit. Apart from this visual indication, DEHNguard YPV SCI ... (FM) arresters also feature a three-pole remote signalling terminal. With its floating changeover contact, the remote signal can be used as make or break contact according to the particular circuit concept.

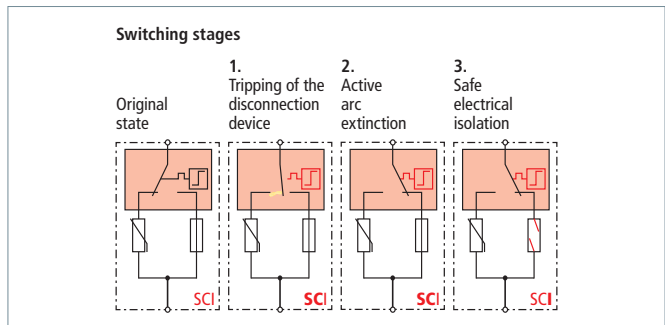

Three-step d.c. switching device (patented SCI principle)

DEHNguard compact YPV SCI ... FM

Multipole surge arrester with three-step d.c. switching device for use in PV systems, with remote signalling contact for monitoring device (floating changeover contact).

Type DG YPV SCI ...	600	600 FM	1000	1000 FM
Part No.	950 531	950 536	950 530	950 535
SPD according to EN 50539-11	type 2	type 2	type 2	type 2
Max. PV voltage (U _{CPV})	600 V	600 V	1000 V	1000 V
Short-circuit current rating (I _{SCPV})	1000 A	1000 A	1000 A	1000 A
Nominal discharge current (8/20 μs) [(DC+/DC-) --> PE] (I _n)	12.5 kA	12.5 kA	12.5 kA	12.5 kA
Max. discharge current (8/20 μs) [(DC+/DC-) --> PE] (I _{max})	25 kA	25 kA	25 kA	25 kA
Voltage protection level (U _p)	≤ 2.5 kV	≤ 2.5 kV	≤ 4 kV	≤ 4 kV
Approvals	KEMA, UL	KEMA, UL	KEMA, UL	KEMA, UL
Type of remote signalling contact	—	changeover contact	—	changeover contact



DEHNCube

- Prewired multipole surge arrester with IP 65 degree of protection for use in photovoltaic systems
- No space required in a distribution board enclosure
- Combined disconnection and short-circuiting device with safe electrical isolation in every protective path (patented SCI principle)
- Spring-loaded terminals for easy and quick connection without tools
- Tested to EN 50539-11
- For use in all PV systems according to IEC 60364-7-712



For protecting low-voltage consumer's installations against surges. For use in accordance with IEC 60364-7-712 (installation of photovoltaic power supply systems).

DEHNCube YPV SCI 1000 1M: Two-pole surge arrester with IP 65 degree of protection and three-step d.c. switching device for protecting one MPP input; for PV systems up to 1000 V

DEHNCube YPV SCI 1000 2M: Four-pole surge arrester with IP 65 degree of protection and three-step d.c. switching device for protecting two MPP inputs; for PV systems up to 1000 V

The robust and flexible surge arresters of the DEHNCube YPV SCI 1000 ... family are specifically developed for protecting equipment in photovoltaic systems. The patented three-step d.c. switching device (SCI principle) makes these devices particularly safe so that they fulfil all requirements in modern photovoltaic systems.

DEHNCube YPV SCI 1000 ... is the first surge arrester with IP 65 degree of protection from DEHN + SÖHNE that is tested to EN 50539-11. Thus, no space is required in a distribution board enclosure or a distribution board enclosure does not have to be installed just for the surge protective device as is the case with standard DIN rail mounted arresters. DEHNCube YPV SCI 1000 ... may be installed right next to the inverter to be protected, i.e. it is ideally suited for quickly and easily retrofitting a surge protective device in an existing PV system. Connection of the DEHNCube YPV SCI 1000 ... is as simple as possible

To fulfil the special requirements in PV systems, the approved fault-resistant Y circuit consisting of three protective paths of the varistor and a combined disconnection and short-circuiting device are integrated in a single device.

This synergy further reduces the probability of an arrester failure in case of the operating and fault states which have to be considered in PV systems.

This ensures that the arrester is protected in case of overload. Even in case of voltages up to 1000 V d.c., a switching arc, which is likely to occur when a conventional disconnecter of a surge protective device is triggered, is extinguished immediately without risk. This is ensured by its approved fault-resistant Y circuit which prevents damage to the surge protective devices in case of insulation faults in the generator circuit.

To ensure safe electrical isolation in case of a faulty surge protective device, a fuse which was particularly developed for PV systems was integrated into the short-circuit path. This unique design combines surge and personal protection. Due to this innovative and unique design, DEHNCube YPV SCI 1000 ... can be used in all low, medium and high-performance photovoltaic systems with no need for an additional backup fuse.

DEHNCube YPV SCI 1000 ... is a special type 2 surge protective device, which may be quickly installed directly next to the equipment of the PV generator circuit it is supposed to protect without requiring an additional insulating enclosure. The IP 65 degree of protection ensures that it is dust-proof and jet-water-tight. A pressure compensating element with an air-permeable and water-tight special grommet which avoids condensation in the enclosure is imperative for safe outdoor use and is therefore already integrated as a standard.

DEHNCube YPV SCI 1000 1M / ... 2M

Two-pole / four-pole surge arrester with IP 65 degree of protection and three-step d.c. switching device for PV inverters for protecting one / two MPP inputs.

Type DCU YPV SCI 1000 ...	1M	2M
Part No.	900 910	900 920
SPD according to EN 50539-11	type 2	type 2
Max. PV voltage (U_{CPV})	1000 V	1000 V
Short-circuit withstand capability (I_{SCP})	1000 A	1000 A
Nominal discharge current (8/20 μ s) [(DC+/DC-) --> PE] (I_n)	12.5 kA	12.5 kA
Max. discharge current (8/20 μ s) [(DC+/DC-) --> PE] (I_{max})	25 kA	25 kA
Voltage protection level (U_p)	≤ 4 kV	≤ 4 kV
Degree of protection	IP 65	IP 65





DEHNguard® PCB



For integrating a type 2 arrester on the printed circuit board of a device to provide surge protection. For installation in conformity with the lightning protection zone concept at the boundaries from 0_B-1 and higher.

- Base for DEHNguard protection modules to be mounted on and integrated in PCBs
- Optimal integration of a type 2 arrester in devices
- Easy and flexible use for all circuit configurations
- Proven DEHNguard modules ensure high performance
- Coded base and protection module ensure against installing an incorrect module
- Version with and without remote signalling contact for the monitoring device
- Versions for maximum requirements on air clearances and creepage distances
- Versions for other DEHNguard protection modules available on request

- DEHNguard PCB ...:** Base for mounting arresters on printed circuit boards
DEHNguard PCB ... FM: With remote signalling contact for monitoring device (floating changeover contact)
DEHNguard PCB ... I ... FM: With increased air clearances and creepage distances between the power and remote signalling contact

The single-pole DEHNguard PCB ... (FM) base is specially designed for use on printed circuit boards (PCBs). Thus, surge protection can be taken into account at an early stage of development of the PCB and can be optimally integrated in the overall product. This single-pole version can be used for all system configurations. Fault-resistant Y circuits for PV systems or 3+1 configurations for a.c. systems can be easily implemented.

Thanks to the ideal positioning of the SPD on the device, an optimal voltage protection level is achieved for the electronics of the PCB since there is no cable length between the SPD and the device to be protected through which additional surges may be injected (in typical applications). The design of the PCB also allows series connection according to IEC 60364-5-53.

Various device features show that reliable surge protection and equipment reliability are a top priority of the modular DEHNguard. The application-oriented product designation, which makes it considerably easier to assign the protection modules to the relevant DG PCB base part, and the unique module locking system reflect the high safety requirements. The

module locking system firmly fixes the protection modules to DEHNguard PCB (FM). Neither vibration in the application environment nor the dynamic forces of discharge can loosen the protection modules. Nevertheless, they can be easily replaced without tools by simply pressing the easy-to-use module release button of the protection modules.

Each DEHNguard PCB (FM) base and each protection module is mechanically coded to ensure against installing an incorrect module.

The DG PCB ... I ... FM versions ensure increased distances between the power and remote signalling contact since special applications place increased requirements on air clearances and creepage distances between these circuits. Details can be found in the drilling scheme of the installation instructions which can be downloaded free of charge at www.dehn-international.com.

The ...FM version of DG PCB... features a three-pole remote signalling contact. With its floating changeover contact, the remote signal can be used as a make or break contact according to the particular circuit concept.

Surge Arresters – Type 2

DEHNguard PCB PV SCI ...

Single-pole base for DEHNguard modules to be mounted on the PCBs of devices.



Type DG PCB ...	PV SCI 300	PV SCI 500	PV SCI 600
Part No.	952 653	952 651	952 654
Associated protection module	DG MOD PV SCI 300 (Part No. 952 053)	DG MOD PV SCI 500 (Part No. 952 051)	DG MOD PV SCI 600 (Part No. 952 054)
Max. continuous operating voltage (d.c.) (module)	300 V	500 V	600 V
Mounting	directly soldered into PCB	directly soldered into PCB	directly soldered into PCB
Degree of protection	IP 20 (protection module plugged in)	IP 20 (protection module plugged in)	IP 20 (protection module plugged in)

DEHNguard PCB PV SCI ... FM

Single-pole base for DEHNguard modules to be mounted on the PCBs of devices, with remote signalling contact for the monitoring system (floating changeover contact).

Type DG PCB ...	PV SCI 300 FM	PV SCI 500 FM	PV SCI 600 FM
Part No.	952 753	952 751	952 754
Associated protection module	DG MOD PV SCI 300 (Part No. 952 053)	DG MOD PV SCI 500 (Part No. 952 051)	DG MOD PV SCI 600 (Part No. 952 054)
Max. continuous operating voltage (d.c.) (module)	300 V	500 V	600 V
Mounting	directly soldered into PCB	directly soldered into PCB	directly soldered into PCB
Degree of protection	IP 20 (protection module plugged in)	IP 20 (protection module plugged in)	IP 20 (protection module plugged in)
Type of remote signalling contact	changeover contact	changeover contact	changeover contact



DEHNguard PCB PV ...

Single-pole base for DEHNguard modules to be mounted on the PCBs of devices.

Type DG PCB ...	PV 300	PV 500	PV 600
Part No.	952 643	952 641	952 644
Associated protection module	DG MOD PV 300 (Part No. 952 043)	DG MOD PV 500 (Part No. 952 041)	DG MOD PV 600 (Part No. 952 044)
Max. continuous operating voltage (d.c.) (module)	300 V	500 V	600 V
Mounting	directly soldered into PCB	directly soldered into PCB	directly soldered into PCB
Degree of protection	IP 20 (protection module plugged in)	IP 20 (protection module plugged in)	IP 20 (protection module plugged in)



DEHNguard PCB PV ... FM

Single-pole base for DEHNguard modules to be mounted on the PCBs of devices, with remote signalling contact for the monitoring system (floating changeover contact).

Type DG PCB ...	PV 300 FM	PV 500 FM	PV 600 FM
Part No.	952 743	952 741	952 744
Associated protection module	DG MOD PV 300 (Part No. 952 043)	DG MOD PV 500 (Part No. 952 041)	DG MOD PV 600 (Part No. 952 044)
Max. continuous operating voltage (d.c.) (module)	300 V	500 V	600 V
Mounting	directly soldered into PCB	directly soldered into PCB	directly soldered into PCB
Degree of protection	IP 20 (protection module plugged in)	IP 20 (protection module plugged in)	IP 20 (protection module plugged in)
Type of remote signalling contact	changeover contact	changeover contact	changeover contact



DEHNguard PCB ...

Single-pole base for DEHNguard modules to be mounted on the PCBs of devices.

Type DG PCB ...	275	385
Part No.	952 610	952 614
Associated protection module	DG MOD 275 (Part No. 952 010)	DG MOD 385 (Part No. 952 014)
Max. continuous operating voltage (a.c.) (module)	275 V	385 V
Mounting	directly soldered into PCB	directly soldered into PCB
Degree of protection	IP 20 (protection module plugged in)	IP 20 (protection module plugged in)



DEHNguard PCB ... FM

Single-pole base for DEHNguard modules to be mounted on the PCBs of devices, with remote signalling contact for the monitoring system (floating changeover contact).

Type DG PCB ...	275 FM	385 FM
Part No.	952 710	952 714
Associated protection module	DG MOD 275 (Part No. 952 010)	DG MOD 385 (Part No. 952 014)
Max. continuous operating voltage (a.c.) (module)	275 V	385 V
Mounting	directly soldered into PCB	directly soldered into PCB
Degree of protection	IP 20 (protection module plugged in)	IP 20 (protection module plugged in)
Type of remote signalling contact	changeover contact	changeover contact



DEHNgard PCB NPE (FM)

Single-pole base for DEHNgard modules to be mounted on the PCBs of devices, with remote signalling contact for the monitoring system (floating changeover contact).



Type DG PCB ...	NPE	NPE FM
Part No.	952 650	952 750
Associated protection module	DG MOD NPE (Part No. 952 050)	DG MOD NPE (Part No. 952 050)
Max. continuous operating voltage (a.c.) (module)	255 V	255 V
Mounting	directly soldered into PCB	directly soldered into PCB
Degree of protection	IP 20 (protection module plugged in)	IP 20 (protection module plugged in)
Type of remote signalling contact	—	changeover contact

DEHNgard PCB PV I ... FM

Single-pole base with increased air clearance and creepage distance between the power contacts and the remote signalling contact. For installation on the PCBs of devices to accommodate DEHNgard modules, with remote signalling contact for the monitoring system (floating changeover contact).

NEW



Type DG PCB ...	PV I 500 FM	PV I 600 FM	PV I 750 FM
Part No.	952 941	952 948 ^{NEW}	952 949 ^{NEW}
Associated protection module	DG MOD PV 500 (Part No. 952 041)	DG MOD PV 500 (Part No. 952 041)	DG MOD PV 500 (Part No. 952 041)
Max. continuous operating voltage (d.c.) (module)	500 V	600 V	750 V
Mounting	directly soldered into PCB	directly soldered into PCB	directly soldered into PCB
Degree of protection	IP 20 (protection module plugged in)	IP 20 (protection module plugged in)	IP 20 (protection module plugged in)
Type of remote signalling contact	changeover contact	changeover contact	changeover contact

DEHNgard PCB PV SCI I ... FM

Single-pole base with increased air clearance and creepage distance between the power contacts and the remote signalling contact. For installation on the PCBs of devices to accommodate DEHNgard modules, with remote signalling contact for the monitoring system (floating changeover contact).



Type DG PCB ...	PVSCI I 500FM
Part No.	952 951
Associated protection module	DG MOD PV SCI 500 (Part No. 952 051)
Max. continuous operating voltage (d.c.) (module)	500 V
Mounting	directly soldered into PCB
Degree of protection	IP 20 (protection module plugged in)
Type of remote signalling contact	changeover contact

DEHNgard PCB I ... FM

Single-pole base with increased air clearance and creepage distance between the power contacts and the remote signalling contact. For installation on the PCB's of devices to accommodate DEHNgard modules, with remote signalling contact for the monitoring system (floating changeover contact).



Type DG PCB ...	I 275 FM
Part No.	952 910
Associated protection module	DG MOD 275 (Part No. 952 010)
Max. continuous operating voltage (a.c.) (module)	275 V
Mounting	directly soldered into PCB
Degree of protection	IP 20 (protection module plugged in)
Type of remote signalling contact	changeover contact



Protection Module for DEHNGuard® M, ... S and DEHNGap C S

- High discharge capacity due to heavy-duty zinc oxide varistors / spark gaps
- High reliability due to “Thermo Dynamic Control” SPD monitoring device
- Energy coordination with other arresters of the Red/Line product family
- Operating state / fault indication by green / red indicator flag in the inspection window
- Easy replacement of protection modules without tools due to module locking system with module release button
- The plug-in protection module can be replaced without disconnecting the supply voltage and without removing the distribution board cover
- Vibration and shock-tested according to EN 60068-2

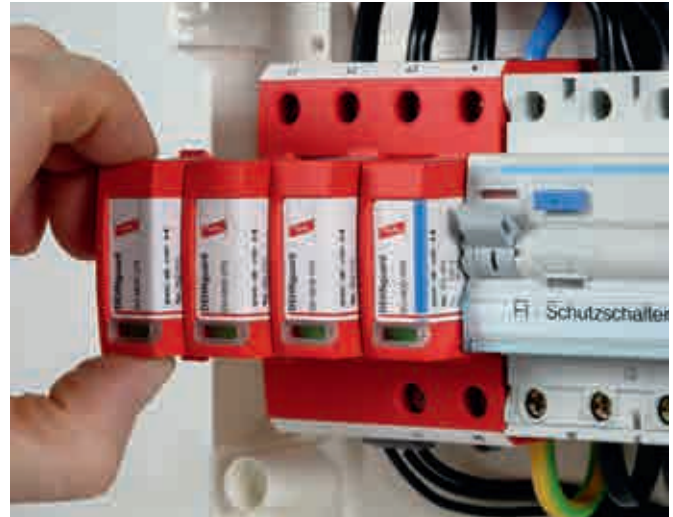

For protecting low-voltage consumer's installations against surges. For installation in conformity with the lightning protection zone concept at the boundaries from $O_B - 1$ and higher.

DEHNGuard MOD CI 275:	Varistor-based protection module for DEHNGuard M CI ... surge arresters
DEHNGuard MOD E CI...:	Varistor-based protection module for DEHNGuard M ... and DEHNGuard SE CI ... surge arresters
DEHNGuard MOD ...:	Varistor-based protection module for DEHNGuard M ... and DEHNGuard S ... surge arresters
DEHNGuard MOD 750:	Varistor-based protection module for DEHNGuard M WE 600 and DEHNGuard S WE 600 surge arresters
DEHNGuard MOD H NPE:	N-PE spark-gap-based protection module for two-pole and four-pole DEHNGuard M H TT ... surge arresters
DEHNGuard MOD NPE:	N-PE spark-gap-based protection module for two-pole and four-pole DEHNGuard M TT ... surge arresters
DEHNGap C MOD:	N-PE spark-gap-based protection module for single-pole N-PE surge arresters of type DEHNGap C S ...
DEHNGuard MOD ... VA:	Varistor-based and spark-gap-based protection module for DEHNGuard S ... VA surge arresters
DEHNGuard MOD H PV ...:	Varistor-based protection module for DEHNGuard M YPV ... surge arresters
DEHNGuard MOD PV SCI ...:	Varistor-based protection module for DEHNGuard M YPV SCI and DEHNGuard S PV SCI ... surge arresters
DEHNGuard MOD PV ...:	Varistor-based protection module for DEHNGuard M YPV SCI and DEHNGuard S PV SCI ... surge arresters
DEHNGuard MOD E PV SCI 750:	Varistor-based protection module for DEHNGuard ME YPV SCI and DEHNGuard SE PV SCI ... surge arresters
DEHNGuard MOD E H LI ...:	Varistor-based protection module for DEHNGuard SE H LI ... FM surge arresters
DEHNGuard MOD E H 1000:	Varistor-based protection module for DEHNGuard SE H 1000 FM surge arresters
DEHNGuard MOD E H 1000 VA :	Varistor-based protection module for DEHNGuard SE H 1000 VA FM surge arresters
DEHNGuard MOD E DC ...:	Varistor-based protection module for DEHNGuard SE DC ... surge arresters

The varistor and spark-gap-based protection modules of the DEHNGuard M, DEHNGuard S, DEHNGuard ME, DEHNGuard SE and DEHNGap C S devices distinguish themselves through their outstanding performance and appearance.

The compact protection modules incorporate the complete protective circuit as well as the monitoring and disconnection device.

The green indicator flag in the inspection window shows the operating state of the protection modules.

All protection modules are mechanically coded to ensure against installing an incorrect module.

The protection modules can be easily replaced without tools by simply pressing the easy-to-use module release button.

Avoid additional, short-notice and unplanned maintenance jobs.

In multipole protective circuits, we recommend replacing the complete set of protection modules when one module fails.

Varistor-Based Protection Module for DEHNGuard M CI

Type	DG MOD CI 275
Part No.	952 020
Nominal discharge current (8/20 μ s) (I_n)	12.5 kA
Max. discharge current (8/20 μ s) (I_{max})	25 kA
Max. continuous operating voltage (a.c.) (U_c)	275 V

Varistor-based Protection Module for DEHNGuard SE CI ...

Type	DG MOD E CI 440	DG MOD E CI WE 440
Part No.	952 926 ^{NEW}	952 927 ^{NEW}
Nominal discharge current (8/20 μ s) (I_n)	12.5 kA	12.5 kA
Max. continuous operating voltage (a.c.) (U_c)	440 V	440 V
Rated varistor voltage (U_{mov})	440 V	750 V



Varistor-based Protection Module for DEHNgard M and DEHNgard S



Type	DG MOD 48	DG MOD 75	DG MOD 150	DG MOD 275
Part No.	952 018	952 011	952 012	952 010
Nominal discharge current (8/20 μ s) (I_n)	7.5 kA	10 kA	15 kA	20 kA
Max. discharge current (8/20 μ s) (I_{max})	25 kA	40 kA	40 kA	40 kA
Max. continuous operating voltage (a.c.) (U_c)	48 V	75 V	150 V	275 V

Type	DG MOD 320	DG MOD 385	DG MOD 440	DG MOD 600
Part No.	952 013	952 014	952 015	952 016
Nominal discharge current (8/20 μ s) (I_n)	20 kA	20 kA	20 kA	15 kA
Max. discharge current (8/20 μ s) (I_{max})	40 kA	40 kA	40 kA	30 kA
Max. continuous operating voltage (a.c.) (U_c)	320 V	385 V	440 V	600 V

Varistor-Based Protection Module for DEHNgard M (S) WE



Type	DG MOD 750
Part No.	952 017
Nominal discharge current (8/20 μ s) (I_n)	15 kA
Max. discharge current (8/20 μ s) (I_{max})	25 kA
Max. continuous operating voltage (a.c.) (U_c)	600 V
Rated varistor voltage (U_{mov})	750 V

N-PE Spark-Gap-Based Protection Module for DEHNgard M TT ...



Type	DG MOD NPE
Part No.	952 050
Nominal discharge current (8/20 μ s) (I_n)	20 kA
Max. discharge current (8/20 μ s) (I_{max})	40 kA
Max. continuous operating voltage (a.c.) (U_c)	255 V

N-PE Spark-Gap-Based Protection Module for DEHNgard M H TT ...



Type	DG MOD H NPE
Part No.	952 081
Nominal discharge current (8/20 μ s) (I_n)	80 kA
Max. discharge current (8/20 μ s) (I_{max})	120 kA
Max. continuous operating voltage (a.c.) (U_c)	255 V

N-PE Spark-Gap-Based Protection Module for DEHNgap C S



Type	DGP C MOD
Part No.	952 060
Nominal discharge current (8/20 μ s) (I_n)	20 kA
Max. discharge current (8/20 μ s) (I_{max})	40 kA
Max. continuous operating voltage (a.c.) (U_c)	255 V

Varistor and Spark-Gap-Based Protection Module for DEHNgard S ... VA



Type	DG MOD 75 VA	DG MOD 275 VA	DG MOD 385 VA
Part No.	952 025	952 027	952 029
Nominal discharge current (8/20 μ s) (I_n)	10 kA	10 kA	10 kA
Max. discharge current (8/20 μ s) (I_{max})	20 kA	20 kA	20 kA
Max. continuous operating voltage (a.c.) (U_c)	75 V	275 V	385 V
Max. continuous operating voltage (d.c.) (U_c)	100 V	350 V	500 V

Varistor-based Protection Module for DEHNgard M YPV

NEW



Type	DG MOD H PV 600	DG MOD H PV 750
Part No.	952 048 ^{NEW}	952 049 ^{NEW}
Nominal discharge current (8/20 μ s) (I_n)	20 kA	15 kA
Max. discharge current (8/20 μ s) (I_{max})	40 kA	40 kA
Max. continuous operating voltage (d.c.) (U_c)	585 V	750 V

Varistor-Based Protection Module for DEHNguard M YPV SCI and DEHNguard S PV SCI

Type DG MOD ...	PV SCI 75	PV SCI 300	PV SCI 500	PV SCI 600
Part No.	952 055	952 053	952 051	952 054
Nominal discharge current (8/20 μ s) (I_n)	10 kA	12.5 kA	12.5 kA	12.5 kA
Max. discharge current (8/20 μ s) (I_{max})	20 kA	25 kA	25 kA	25 kA
Max. continuous operating voltage (d.c.) (U_c)	75 V	300 V	500 V	600 V



Varistor-Based Protection Module for DEHNguard M YPV SCI and DEHNguard S PV SCI

Type DG MOD ...	PV 75	PV 300	PV 500	PV 600
Part No.	952 045	952 043	952 041	952 044
Nominal discharge current (8/20 μ s) (I_n)	10 kA	20 kA	20 kA	15 kA
Max. discharge current (8/20 μ s) (I_{max})	40 kA	40 kA	40 kA	30 kA
Max. continuous operating voltage (d.c.) (U_c)	75 V	300 V	500 V	600 V



Varistor-Based Protection Module for DEHNguard ME YPV SCI and DEHNguard SE PV SCI

Type DG MOD ...	E PV SCI 750
Part No.	952 056
Nominal discharge current (8/20 μ s) (I_n)	12.5 kA
Max. discharge current (8/20 μ s) (I_{max})	25 kA
Max. continuous operating voltage (d.c.) (U_c)	750 V



Varistor-Based Protection Module for DEHNguard SE H ...

Type DG MOD ...	E H LI 275	E H LI 1000	E H 1000	E H 1000 VA
Part No.	952 900	952 907	952 908	952 918 ^{NEW}
Nominal discharge current (8/20 μ s) (I_n)	30 kA	20 kA	20 kA	15 kA
Max. discharge current (8/20 μ s) (I_{max})	65 kA	40 kA	40 kA	40 kA
Max. continuous operating voltage (a.c.) (U_c)	275 V	1000 V	1000 V	1000 V



Varistor-based Protection Module for DEHNguard SE DC

Type DG MOD ...	E DC 60	E DC 242	E DC 550	E DC 900
Part No.	972 010	972 020	972 030	972 040
Nominal discharge current (8/20 μ s) (I_n)	12.5 kA	12.5 kA	12.5 kA	12.5 kA
Max. continuous operating voltage (d.c.) (U_c)	60 V	242 V	550 V	900 V





DEHNGuard® 1000



For protecting low voltage consumer's installations against surges. For installation in conformity with the lightning protection zone concept at the boundaries from $O_B - 1$ and higher.

- High discharge capacity due to heavy-duty zinc oxide varistor
- Quick response
- High reliability due to "Thermo Dynamic Control" disconnecter
- Fault indication by green/red indicator flag in the inspection window
- Specifically designed for high system voltages

DEHNGuard 1000: Compact single-pole surge arrester with a rated voltage $U_c = 1000 \text{ V a.c. or } 1000 \text{ V d.c.}$
DEHNGuard 1000 FM: With remote signalling contact for monitoring device (floating changeover contact)

With a rated voltage of 1000 V, the compact and powerful single-pole DEHNGuard 1000 (FM) surge arresters can be used for a wide range of applications.

The DEHNGuard family is not only characterised by its high degree of flexibility, but also by its distinctive performance parameters which set standards worldwide: The high discharge capacity, low voltage protection level and dual „Thermo Dynamic Control“ monitoring and disconnection device ensure maximum reliability.

The DEHN-specific „Thermo Dynamic Control“ disconnecter ensures that the arresters change into a safe, isolated state even in case of extreme overload. For this purpose, the surface temperature of the heavy-duty varistor and the intensity of the discharge current are used for evaluation.

The external design of the device reflects its field of application. DEHNGuard 1000 (FM), with a width of two modules, entirely fulfils all mechanical requirements resulting from the high system voltages.

Apart from the standard visual indication with green and red indicator flags, DEHNGuard ... FM arresters feature a three-pole remote signalling terminal. With its floating changeover contact, the remote signal can be used as a break or make contact according to the particular circuit concept.



DEHNGuard 1000 (FM)

Compact single-pole surge arrester; FM version with floating remote signalling contact.

Type DG ...	1000	1000 FM
Part No.	950 102	950 112
SPD according to EN 61643-11 / IEC 61643-11	type 2 / class II	type 2 / class II
Max. continuous operating voltage (a.c.) (U_c)	1000 V (50 / 60 Hz)	1000 V (50 / 60 Hz)
Max. discharge current (8/20 μ s) (I_{max})	30 kA	30 kA
Voltage protection level (U_p)	$\leq 4.2 \text{ kV}$	$\leq 4.2 \text{ kV}$
Max. overcurrent protection	100 A aM	100 A aM
Max. overcurrent protection at $U \leq 690 \text{ V a.c.}$	125 A gG	125 A gG
Approvals	UL	UL
Type of remote signalling contact	—	changeover contact



Accessories for DEHNGuard® 1000

Earthing Clip for two-module Enclosures, single-phase, two-pole / three-pole / four-pole

Earthing clip for connecting the earth terminal of e.g. two/three/four SPDs with two-module enclosure to earth, with terminal.

Type	EB 1 2 5	EB DG 1000 1 3	EB 1 4 9
Part No.	900 419	900 411	900 417
Dimensions	34 x 77 x 28 mm	34 x 112 x 28 mm	34 x 148 x 28 mm
Terminal	up to 25 mm ²	up to 25 mm ²	up to 25 mm ²



V NH / VA NH

- Surge arrester for use in NH 00 and 1 fuse holders
- Zinc oxide varistor with monitoring device, disconnecter and integrated backup fuse (VA NH... with additional spark gap connected in series)
- Energy coordination with other arresters of the Red/Line product family
- Fault indication by tripping indicator

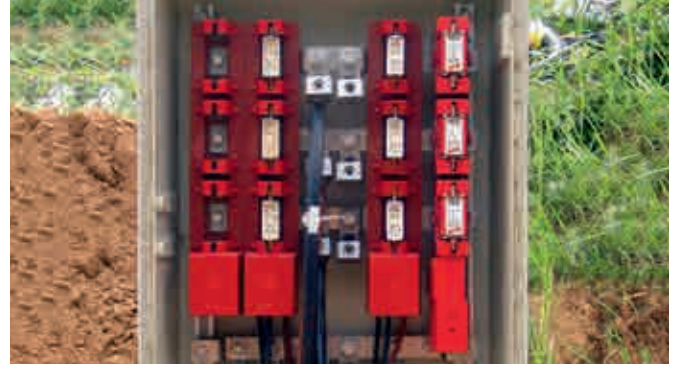

For protecting low voltage consumer's installations against surges. For installation in conformity with the lightning protection zone concept at the boundaries from $O_B - 1$ and higher. German patented design.

V(A) NH00 280: Surge arrester for use in NH00 fuse holders

V(A) NH1 280: Surge arrester for use in NH1 fuse holders

V(A) NH00 280 FM: With fault indicator for remote signalling; allows for use of NH fuse holders with microswitch (max. tripping distance of indicator of 7 mm)

The single-pole V NH and VA NH surge arresters show that surge protective devices do not necessarily have to be designed for DIN rails or socket outlets. Adapted to the requirements in industrial sub-circuit distribution boards, V NH and VA NH surge arresters are designed in the form of an NH fuse holder. This allows to easily integrate them into busbar systems which are frequently used in the environment of utility operators or in industrial plants. Thus, these surge protective devices offer all the advantages of busbar systems such as easy installation, low installation time and reduced wiring. The idea of such a busbar system is consistently continued with arresters in NH design. V NH and VA NH surge arresters can be installed and removed by means of a fuse switch-disconnector and a fuse handle. This considerably facilitates insulation measurements in the installation as the arrester does not have to be disconnected any more.



Another considerable advantage of the V NH / VA NH family is that a backup fuse is already integrated in the arrester. In case of earth-fault and short-circuit-proof wiring, this considerably saves costs and reduces space requirements in distribution boards. In case of



the VA NH version, a spark gap is connected in series with the heavy-duty zinc oxide varistor with thermal monitoring and disconnection device of the V NH surge arresters. VA NH devices are used to reliably protect large-scale systems with permanent insulation monitoring. Apart from the standard visual indication by a tripping indicator, V(A) NH ... FM surge arresters feature a microswitch integrated in the NH fuse holder for remote signalling.

V NH00 (FM)

Varistor-based surge arrester with integrated backup fuse for use in NH00 fuse holders, optionally available with special indicator for remote signalling.



Type	V NH00 280	V NH00 280 FM
Part No.	900 261	900 263
SPD according to EN 61643-11 / IEC 61643-11	type 2 / class II	type 2 / class II
Max. continuous operating voltage (a.c.) (U_c)	280 V (50 / 60 Hz)	280 V (50 / 60 Hz)
Max. discharge current (8/20 μ s) (I_{max})	30 kA	30 kA
Voltage protection level (U_p)	≤ 1.5 kV	≤ 1.5 kV
Max. mains-side overcurrent protection	not required	not required
Indicator for remote signalling	—	tripping distance of 7 mm

V NH1

Varistor-based surge arrester with integrated backup fuse for use in NH1 fuse holders.



Type	V NH1 280
Part No.	900 270
SPD according to EN 61643-11 / IEC 61643-11	type 2 / class II
Max. continuous operating voltage (a.c.) (U_c)	280 V (50 / 60 Hz)
Max. discharge current (8/20 μ s) (I_{max})	30 kA
Voltage protection level (U_p)	≤ 1.5 kV
Max. mains-side overcurrent protection	not required

VA NH00 (FM)

Surge arrester based on a series-connected varistor and spark gap with integrated backup fuse; for use in NH00 fuse holders, optionally available with special indicator for remote signalling.



Type	VA NH00 280	VA NH00 280 FM
Part No.	900 262	900 264
SPD according to EN 61643-11 / IEC 61643-11	type 2 / class II	Type 2 / Class II
Max. continuous operating voltage (a.c.) (U_c)	280 V (50 / 60 Hz)	280 V (50 / 60 Hz)
Max. discharge current (8/20 μ s) (I_{max})	20 kA	20 kA
Voltage protection level (U_p)	≤ 1.5 kV	≤ 1.5 kV
Max. mains-side overcurrent protection	not required	not required
Indicator for remote signalling	—	tripping distance of 7 mm

VA NH1

Surge arrester based on a series-connected varistor and spark gap with integrated backup fuse; for use in NH1 fuse holders.



Type	VA NH1 280
Part No.	900 271
SPD according to EN 61643-11 / IEC 61643-11	type 2 / class II
Max. continuous operating voltage (a.c.) (U_c)	280 V (50 / 60 Hz)
Max. discharge current (8/20 μ s) (I_{max})	20 kA
Voltage protection level (U_p)	≤ 1.5 kV
Max. mains-side overcurrent protection	not required

Selection Chart

DIN rail	Cable duct / flush-mounted system	Socket outlets (modules)	Socket outlets (adapters)	Acoustic fault indication	Visual fault indication	Remote signalling contact	Series connection	Type	Part No.	Page
•					•		•	DR M 2P 255	953 200	104
•					•	•	•	DR M 2P 255 FM	953 205	105
•					•		•	DR M 4P 255	953 400	106
•					•	•	•	DR M 4P 255 FM	953 405	106
•					•			DR M 2P 255 SN1802	953 228	105
•					•	•		DR M 2P 255 SN1803FM	953 229	105
•					•	•		DR M 4P 255 SN1872 FM	953 406	106
•					•		•	SPS PRO	912 253	109
	•	•			•		•	DSA 230 LA	924 370	111
	•	•			•			NSM PRO ...	924 33X	112
	•	•		•				STC 230	924 350	113
	•	•		•				DFL M 255	924 396	115
	•	•		•				DFL A 255	924 389	115
	•	•		•			•	DFL D 255	924 395	115
			•		•			DPRO 230	909 230	117
			•		•			DPRO 230 F	909 240	117
			•		•			SFL PRO 6X	909 250	118
			•		•			SFL PRO 6X 19"	909 251	118



DEHNrail modular



For protecting the power supply circuits of industrial electronics equipment against transients in switchgear cabinets. For installation in conformity with the lightning protection zone concept at the boundaries from 1 – 2 and higher.

The modular devices of the DEHNrail M product family stand out due to their high performance parameters and straightforward Red/Line design. The devices combine safety and ease of use in a single module. The low voltage protection level and the comprehensive protection against common-mode and differential-mode interference make them ideal for protecting terminal equipment in industrial electronics environments. The input and output terminals for series connection and the protective circuit designed for high load currents underline this concept.

The very compact design of the DEHNrail M surge arresters includes the fault-proof Y protective circuit and a combined SPD monitoring and disconnection device.

The base part and protection module are coded to ensure against installing an incorrect module.

The unique module locking system of the DEHNrail M product family fixes the protection module to the base part. Neither vibration during transport nor the electrodynamic forces of discharge can loosen the connection.

- Two-pole surge arrester consisting of a base part and a plug-in protection module
- High discharge capacity due to heavy-duty zinc oxide varistor / spark gap combination
- Energy coordination with other arresters of the Red/Line product family
- Operating state / fault indication by green / red indicator flag in the inspection window
- Narrow (modular) design according to DIN 43880
- Easy replacement of protection modules due to module locking system with module release button
- Vibration and shock-tested according to EN 60068-2

DEHNrail M 2P ...: Two-pole surge arrester consisting of a base part and a plug-in protection module

DEHNrail M 2P ... FM: With remote signalling contact for monitoring device (floating changeover contact)

In the event of the protective circuit being overloaded, the protection modules can be easily replaced without tools by simply pressing the module release button.



In addition to the standard visual indication with green and red indicator flags, DEHNrail M ... FM devices feature a three-pole remote signalling terminal. With its floating changeover contact, the remote signal can be used as a break or make contact according to the particular circuit concept.

DEHNrail M 2P ...

Two-pole surge arrester consisting of a base part and a plug-in protection module.

General Information:	
SPD according to EN 61643-11 / IEC 61643-11	type 3 / class III
Max. mains-side overcurrent protection	25 A gG or B 25 A
Approvals	KEMA, VDE, UL, CSA

Type DR M 2P ...	30	60	75
Part. No.	953 201	953 202	953 203
Max. continuous operating voltage (a.c.) (U_C)	30 V (50 / 60 Hz)	60 V (50 / 60 Hz)	75 V (50 / 60 Hz)
Max. continuous operating voltage (d.c.) (U_C)	30 V	60 V	75 V
Nominal discharge current (8/20 μ s) (I_n)	1 kA	1 kA	2 kA
Total discharge current (8/20 μ s) [L+N-PE] (I_{total})	2 kA	2 kA	4 kA
Voltage protection level [L-N] / [L/N-PE] (U_p)	$\leq 180 / \leq 630$ V	$\leq 350 / \leq 730$ V	$\leq 400 / \leq 730$ V

Type DR M 2P ...	150	255
Part. No.	953 204	953 200
Max. continuous operating voltage (a.c.) (U_C)	150 V (50 / 60 Hz)	255 V (50 / 60 Hz)
Max. continuous operating voltage (d.c.) (U_C)	150 V	255 V
Nominal discharge current (8/20 μ s) (I_n)	2 kA	3 kA
Total discharge current (8/20 μ s) [L+N-PE] (I_{total})	4 kA	5 kA
Voltage protection level [L-N] / [L/N-PE] (U_p)	$\leq 640 / \leq 800$ V	$\leq 1250 / \leq 1500$ V



DEHNrail M 2P ... FM

Two-pole surge arrester consisting of a base part and a plug-in protection module; with floating remote signalling contact.

General Information:	
SPD according to EN 61643-11 / IEC 61643-11	type 3 / class III
Max. mains-side overcurrent protection	25 A gG or B 25 A
Approvals	KEMA, VDE, UL, CSA
Type of remote signalling contact	changeover contact

Type DR M 2P ...	30 FM	60 FM	75 FM
Part. No.	953 206	953 207	953 208
Max. continuous operating voltage (a.c.) (U_c)	30 V (50 / 60 Hz)	60 V (50 / 60 Hz)	75 V (50 / 60 Hz)
Max. continuous operating voltage (d.c.) (U_c)	30 V	60 V	75 V
Nominal discharge current (8/20 μ s) (I_n)	1 kA	1 kA	2 kA
Total discharge current (8/20 μ s) [L+N-PE] (I_{total})	2 kA	2 kA	4 kA
Voltage protection level [L-N] / [L/N-PE] (U_p)	$\leq 180 / \leq 630$ V	$\leq 350 / \leq 730$ V	$\leq 400 / \leq 730$ V

Type DR M 2P ...	150 FM	255 FM
Part. No.	953 209	953 205
Max. continuous operating voltage (a.c.) (U_c)	150 V (50 / 60 Hz)	255 V (50 / 60 Hz)
Max. continuous operating voltage (d.c.) (U_c)	150 V	255 V
Nominal discharge current (8/20 μ s) (I_n)	2 kA	3 kA
Total discharge current (8/20 μ s) [L+N-PE] (I_{total})	4 kA	5 kA
Voltage protection level [L-N] / [L/N-PE] (U_p)	$\leq 640 / \leq 800$ V	$\leq 1250 / \leq 1500$ V



DEHNrail M 2P SN1802

Two-pole surge arrester consisting of a base part and a plug-in protection module. Usable for systems with a load current up to 32 A.

Type DR M 2P ...	255 SN1802
Part. No.	953 228 ^{NEW}
SPD according to EN 61643-11 / IEC 61643-11	type 3 / class III
Max. continuous operating voltage (a.c.) (U_c)	255 V (50 / 60 Hz)
Max. continuous operating voltage (d.c.) (U_c)	255 V
Nominal discharge current (8/20 μ s) (I_n)	3 kA
Total discharge current (8/20 μ s) [L+N-PE] (I_{total})	5 kA
Voltage protection level [L-N] / [L/N-PE] (U_p)	$\leq 1250 / \leq 1500$ V
Max. mains-side overcurrent protection	32 A gG or B 32 A

Protection module upon request



DEHNrail M 2P SN1803FM

Two-pole surge arrester consisting of a base part and a plug-in protection module; with floating remote signalling contact. Usable for systems with a load current up to 32 A.

Type DR M 2P ...	255 SN1803FM
Part. No.	953 229 ^{NEW}
SPD according to EN 61643-11 / IEC 61643-11	type 3 / class III
Max. continuous operating voltage (a.c.) (U_c)	255 V (50 / 60 Hz)
Max. continuous operating voltage (d.c.) (U_c)	255 V
Nominal discharge current (8/20 μ s) (I_n)	3 kA
Total discharge current (8/20 μ s) [L+N-PE] (I_{total})	5 kA
Voltage protection level [L-N] / [L/N-PE] (U_p)	$\leq 1250 / \leq 1500$ V
Max. mains-side overcurrent protection	32 A gG or B 32 A
Type of remote signalling contact	changeover contact

Protection module upon request





DEHNrail modular, multipole

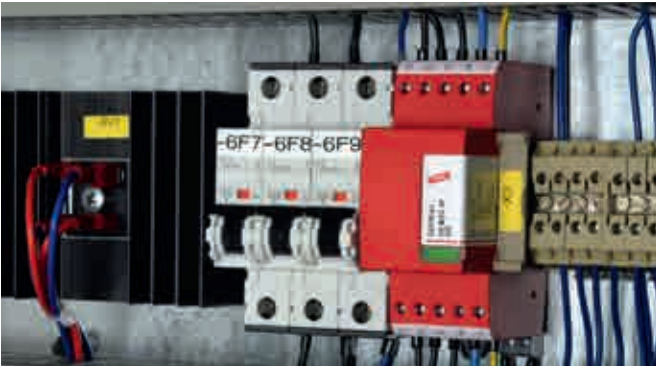

For protecting the power supply circuits of industrial electronics equipment against transients in switchgear cabinets. For installation in conformity with the lightning protection zone concept at the boundaries from 1 – 2 and higher.

The modular four-pole DEHNrail M 4P ... (FM) surge arresters are specifically developed for protecting three-phase industrial electronics terminal equipment. Adapted to this kind of environment, the arresters with the Red/Line design are suitable for 35 mm DIN rails. The low voltage protection level and the comprehensive protection against common-mode and differential-mode interference are characteristic of DEHNrail M 4P ... (FM). To provide optimal low voltage protection levels for the terminal equipment to be protected, the device features input and output terminals for series connection. DEHNrail M 4P ... (FM) devices ideally adapt to the cable run upstream of the terminal equipment. Therefore, no additional terminal blocks for outgoing cables are required. The compact design incorporates the tried and tested disconnecter. It disconnects an overloaded arrester circuit without interrupting the supply circuit.

The base part and protection module are coded to ensure against installing the incorrect module.

The unique module locking system of the DEHNrail M family fixes the protection modules to the base part. Neither vibrations during transport nor the electrodynamic forces of discharge can loosen the connection.

- Four-pole surge arrester consisting of a base part and a plug-in protection module
- High discharge capacity due to heavy-duty zinc oxide varistor / spark gap combination
- Energy coordination with other arresters of the Red/Line product family
- Operating state / fault indication by green / red indicator flag in the inspection window
- Easy replacement of protection modules without tools due to module locking system with module release button
- Nominal load currents up to 25 A
- Vibration and shock-tested in accordance with EN 60068-2

DEHNrail M 4P ...: Four-pole surge arrester consisting of a base part and a plug-in protection module

DEHNrail M 4P ... FM: With remote signalling contact for monitoring device (floating changeover contact)

In the event of the protective circuit, which is rated for high load currents up to 25 A, being overloaded, the protection modules can be easily replaced without tools by simply pressing the module release button.



Apart from the standard visual indication with green and red indicator flags, DEHNrail M 4P ...

FM devices feature a three-pole remote signalling terminal. With its floating changeover contact, the remote signal can be used as a break or make contact according to the particular circuit concept.

DEHN rail M 4P ... (FM)

Four-pole surge arrester consisting of a base part and a plug-in protection module for 230 / 400 V systems; FM version with floating remote signalling contact.

Type DR M 4P ...	255	255 FM
Part. No.	953 400	953 405
SPD according to EN 61643-11 / IEC 61643-11	type 3 / class III	type 3 / class III
Max. continuous operating voltage (a.c.) (U_C)	255 / 440 V (50 / 60 Hz)	255 / 440 V (50 / 60 Hz)
Nominal discharge current (8/20 μ s) (I_n)	3 kA	3 kA
Total discharge current (8/20 μ s) [L1+L2+L3+N-PE] (I_{total})	8 kA	8 kA
Voltage protection level [L-N] / [L/N-PE] (U_P)	$\leq 1000 / \leq 1500$ V	$\leq 1000 / \leq 1500$ V
Max. mains-side overcurrent protection	25 A gG or B 25 A	25 A gG or B 25 A
Approvals	KEMA, VDE	KEMA, VDE
Type of remote signalling contact	—	changeover contact

DEHNrail M 4P SN1872FM

Four-pole surge arrester consisting of a base part and a plug-in protection module; with floating remote signalling contact. Usable for systems with a fusing up to 32 A.

Type DR M 4P ...	255 SN1872 FM
Part. No.	953 406 ^{NEW}
SPD according to EN 61643-11 / IEC 61643-11	type 3 / class III
Max. continuous operating voltage (a.c.) (U_C)	255 / 440 V (50 / 60 Hz)
Nominal discharge current (8/20 μ s) (I_n)	3 kA
Total discharge current (8/20 μ s) [L1+L2+L3+N-PE] (I_{total})	8 kA
Voltage protection level [L-N] / [L/N-PE] (U_P)	$\leq 1000 / \leq 1500$ V
Max. mains-side overcurrent protection	32 A gG oder B 32 A
Type of remote signalling contact	changeover contact



NEW



Protection Module for DEHNRail modular

- High discharge capacity due to heavy-duty zinc oxide varistor / spark gap combination
- High reliability due to “Thermo Dynamic Control” disconnecter with dual monitoring
- Energy coordination with other arresters of the Red/Line product family
- Easy replacement of protection modules without tools due to module locking system with module release button
- Operating state / fault indication by green / red indicator flag in the inspection window
- The plug-in protection module can be replaced without the need to de-energise and without removing the distribution board cover
- Vibration and shock-tested in accordance with EN 60068-2

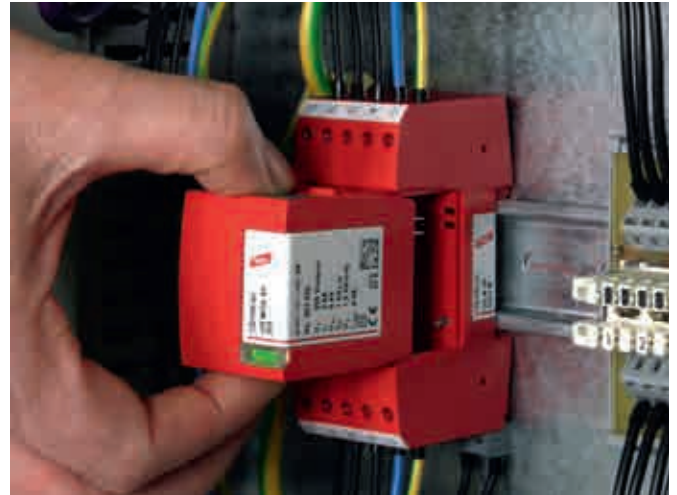

For protecting the power supply circuits of industrial electronics equipment against surges in switchgear cabinets. For installation in conformity with the lightning protection zone concept at the boundaries from 1 – 2 and higher.

DEHNRail MOD ...: For all types of two-pole DEHNRail M 2P ... surge arresters

DEHNRail MOD 4P...: For all types of four-pole DEHNRail M 4P ... surge arresters

Protection Module for DEHNRail M 2P

Protection module with integrated Y protection circuit.

Type DR MOD ...	30	60	75
Part. No.	953 011	953 012	953 013
Nominal discharge current (8/20 μ s) (I_n)	1 kA	1 kA	2 kA
Total discharge current (8/20 μ s) [L+N-PE] (I_{total})	2 kA	2 kA	4 kA
Max. continuous operating voltage (a.c.) (U_c)	30 V	60 V	75 V

Type DR MOD ...	150	255
Part. No.	953 014	953 010
Nominal discharge current (8/20 μ s) (I_n)	2 kA	3 kA
Total discharge current (8/20 μ s) [L+N-PE] (I_{total})	4 kA	5 kA
Max. continuous operating voltage (a.c.) (U_c)	150 V	255 V



Protection Module for DEHNRail M 4P

Four-pole protection module with integrated protective circuit.

Type DR MOD ...	4P 255	4P 255 SN1871
Part. No.	953 020	953 021
Nominal discharge current (8/20 μ s) (I_n)	3 kA	3 kA
Total discharge current (8/20 μ s) [L+N-PE] (I_{total})	8 kA	8 kA
Max. continuous operating voltage (a.c.) (U_c)	255 V	255 V





Mains Filter



- Protection of sensitive industrial electronics equipment against balanced and unbalanced high-frequency interference
- For use in combination with surge protective devices, e.g. DEHNrail M 2P 255
- Easy installation on DIN rails in switchgear cabinets

The NF 10 mains filter ideally complements surge protective devices for industrial terminal equipment. This DIN rail mounted device is perfectly suited for installation downstream of surge protective devices (e.g. DEHNrail M 2P 255). In addition to surge protection, protection against balanced and unbalanced high-frequency interference is provided. The

separate input and output terminals of the mains filter ensure optimal protection of the equipment to be protected. Apart from surge protection, the mains filter also fulfils electromagnetic compatibility requirements in plant and control systems.

NF 10

Mains filter for protection against balanced and unbalanced interferences.



Type	NF 10
Part. No.	912 254
Nominal voltage (a.c.) (U_N)	230 V
Nominal load current (a.c.) (I_N)	10 A
Attenuation for $f = 1$ MHz, balanced	> 64 dB
Attenuation for $f = 1$ MHz, unbalanced	> 69 dB



SPS Protector

- Combination of surge protection and filter
- Surge protection with monitoring device and disconnector
- Interference suppressor filter for protecting sensitive industrial electronics equipment against balanced and unbalanced high-frequency interference
- Integrated in a shielded enclosure
- Visual operating state indication (green) and floating remote signalling contact (break contact) for fault indication



For protecting the power supply circuits of industrial electronics equipment (e.g. programmable logic controls (PLCs)) against transients and high-frequency interference voltages. For installation in conformity with the lightning protection zone concept at the boundaries from 1 – 2 and higher.

SPS Protector: Two-pole surge arrester with interference suppressor filter

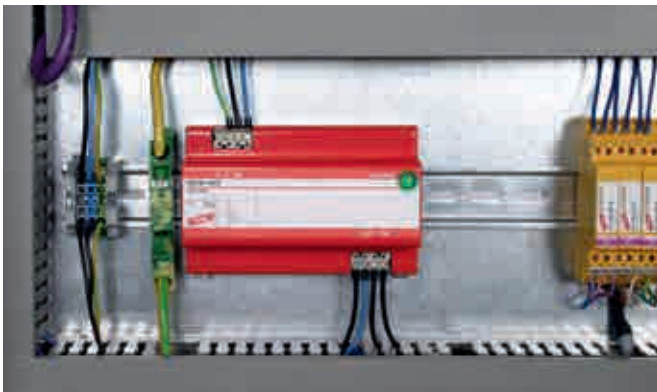

The SPS Protector combines surge protection and interference suppressor filter in a compact device. This makes it ideal for protecting sensitive terminal equipment of industrial automation systems (e.g. programmable logic controls (PLCs)). The coordinated surge protection and filter functions complement one another and prevent core saturation of the filter in the event of high-level transients. The separate input and output terminals provide optimal protection for the device to be protected. The metal enclosure of the SPS Protector ensures that high-frequency interferences are discharged without interfering with other devices in the immediate vicinity. The compact design of the SPS Protector already houses the proven disconnector. In case of overload, it disconnects the arrester without interrupting the power supply circuit. Apart from the green indicator light, SPS Protectors also feature a remote signalling contact.

SPS Protector

Surge arrester with interference suppressor filter for single-phase 230 V TT and TN systems; with floating remote signalling contact.

Type	SPS PRO
Part. No.	912 253
SPD according to EN 61643-11 / IEC 61643-11	type 3 / class III
Max. continuous operating voltage (a.c.) (U_c)	255 V (50 / 60 Hz)
Nominal load current (a.c.) (I_l)	3 A
Nominal discharge current (8/20 μ s) (I_n)	3 kA
Total discharge current (8/20 μ s) [L+N-PE] (I_{total})	5 kA
Voltage protection level [L-N] / [L/N-PE] (U_p)	≤ 800 / ≤ 1000 V
Type of remote signalling contact	break contact





DEHNsafe



For protecting electronic devices against surges. For installation in electrical installation systems, e.g. cable ducts or flush-type boxes. For installation in conformity with the lightning protection zone concept at the boundaries from 1 – 2 and higher.

DEHNsafe 230 LA: Surge protective device for use in cable ducts

DEHNsafe surge arresters particularly stand out due to their flexible application options. Thanks to their small mounting depth of only 31 mm, the two-pole surge protective devices for 230 V terminal equipment can be installed both in cable ducts and in flat flush-type boxes. DEHNsafe incorporates a monitoring device and a thermal disconnecter. In addition to a visual operating state indicator, the device features a programmable acoustic fault indicator which can be programmed for three different operating states:

- Acoustic fault indication,
- Test function,
- Muting of the acoustic signal.

Surge Arrester for Use in Cable Ducts

- Two-pole surge protective device for 230 V terminal equipment
- For use in flush-type boxes and cable ducts
- Enhanced safety due to fault-proof Y protective circuit
- Multiple visual indicator
- Programmable acoustic function
- Terminals for series connection
- Independent of the socket outlet design



DEHNsafe surge arresters are covered by a triple TAE cover from any switch range manufacturer, thus ideally adapting to any socket outlet design.

The double terminals for L, N and PE allow for series connection to ensure that the surge protective device is situated in parallel to the circuit to be protected. For this reason, DEHNsafe does not necessarily interrupt the circuit to be protected in case of overload. They feature a green and red LED for visual inspection.

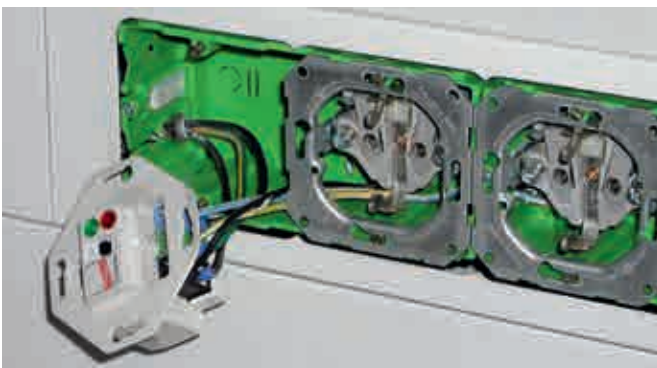

Surge Arresters – Type 3

DEHNsafe

Surge protective device for use in cable ducts and flush-type boxes. For single-phase 230 V TT and TN systems.

Type	DSA 230 LA
Part. No.	924 370
SPD according to EN 61643-11 / IEC 61643-11	type 3 / class III
Max. continuous operating voltage (a.c.) (U_c)	255 V (50 / 60 Hz)
Nominal discharge current (8/20 μ s) (I_n)	3 kA
Total discharge current (8/20 μ s) [L+N-PE] (I_{total})	5 kA
Voltage protection level [L-N] / [L/N-PE] (U_p)	$\leq 1250 / \leq 1500$ V
Max. mains-side overcurrent protection	B 16 A
Fault indication	red light + acoustic signal
Operating state indication	green light



Accessories for DEHNsafe

Central Covering Plate

Single unit, alpha exclusive.

Type	ZAP STW
Part. No.	924 329
Colour	studio white



Cover Frame

Single unit, alpha exclusive.

Type	AR1 STW
Part. No.	924 328
Colour	studio white





NSM Protector



For protecting electronic equipment against surges. Earthed socket outlet with surge protective circuit for installation in electrical installation systems. For installation in conformity with the lightning protection zone concept at the boundaries from 1 – 2 and higher. German utility patent.

- Surge protection with monitoring device and disconnecter
- Enhanced safety due to fault-proof Y protective circuit
- Visual operating state (green) and fault indication (red)
- With retaining ring (diameter of 60 mm) for installation in switch boxes with a diameter of 60 mm and a depth of 40 mm

NSM Protector: Earthed socket outlet with integrated surge protection

The devices of the NSM Protector family combine surge protection and earthed socket outlet in a single device. The two-pole surge arresters are specifically designed for protecting electronic loads in final circuits. Their very compact design incorporates the approved disconnecter which disconnects overloaded surge arresters without interrupting the supply circuit. The low voltage protection level as well as the comprehensive pro-

tection against common-mode and differential-mode interference are typical of the devices of the NSM Protector family. The fault-proof Y protective circuit ensures safety even if the phase and neutral conductors in final circuits cannot be identified. The integrated disconnecter ensures reliability of devices and installations. The standard green and red LEDs indicate the operating state of the surge protective devices.

NSM PRO

Socket outlet with integrated surge protection for single-phase 230 V TT and TN systems.



Type	NSM PRO TW
Part. No.	924 335
SPD according to EN 61643-11 / IEC 61643-11	type 3 / class III
Max. continuous operating voltage (a.c.) (U_C)	255 V (50 / 60 Hz)
Nominal discharge current (8/20 μ s) (I_n)	3 kA
Total discharge current (8/20 μ s) [L+N-PE] (I_{total})	5 kA
Voltage protection level [L-N] / [L/N-PE] (U_P)	≤ 1250 / ≤ 1500 V
Max. mains-side overcurrent protection	B 16 A
Fault indication	red light
Operating state indication	green light
DELTA Profil line	titanium white

Accessories for NSM Protector



AR1 Cover Frame

Single unit, suitable for NSM Protector.

Type	AR1 TW
Part. No.	924 336
Type	DELTA profil, titanium white



STC Module

- Two-pole surge arrester with monitoring device and disconnecter
- Enhanced safety due to fault-proof Y protective circuit
- Acoustic fault indication
- For installation in standard earthed socket outlets
- Independent of the socket outlet design
- Plastic snap-on retaining ring for easy installation in already mounted socket outlets

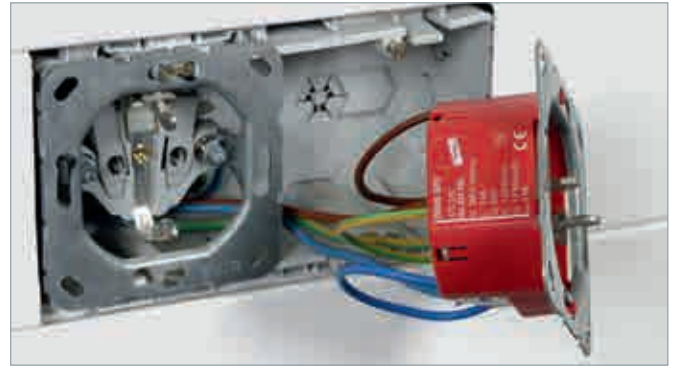

For protecting electronic devices against surges. For use with standard earthed socket outlets. For installation in conformity with the lightning protection zone concept at the boundaries from 1 – 2 and higher.

STC 230: Snap-on module for standard earthed socket outlets



The well received two-pole STC surge arrester can be fitted inconspicuously on the rear side of many standard earthed socket outlets. The STC surge protection module thus adapts to every type of socket outlet. The plastic snap-on retaining ring allows easy installation even in already mounted earthed socket outlets. In addition to a thermal disconnecter, the protective device features an acoustic fault indication. As the surge protection module is installed in parallel to the socket outlet, the power supply of the connected loads remains uninterrupted, even if the surge arrester is overloaded.

STC 230

Two-pole surge arrester for single-phase 230 V TT and TN systems is snapped on earthed socket outlets.

Type	STC 230
Part. No.	924 350
SPD according to EN 61643-11 / IEC 61643-11	type 3 / class III
Max. continuous operating voltage (a.c.) (U_c)	255 V (50 / 60 Hz)
Nominal discharge current (8/20 μ s) (I_n)	3 kA
Total discharge current (8/20 μ s) [L+N-PE] (I_{total})	5 kA
Voltage protection level [L-N] / [L/N-PE] (U_p)	≤ 1250 / ≤ 1500 V
Max. mains-side overcurrent protection	B 16 A
Fault indication	acoustic signal on

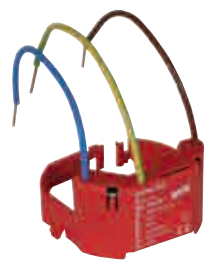



DEHNflex



- Two-pole surge arrester with monitoring device and disconnecter
- Enhanced safety due to fault-proof Y protective circuit
- Acoustic fault indication
- Compact design
- For use in flush-mounted systems, cable ducts and flush-type boxes

For protecting electronic equipment against surges. For installation in electrical installation systems, e.g. flush-mounted systems, cable ducts and flush-type boxes. German utility patent for DEHNflex A / ... D. For installation in conformity with the lightning protection zone concept at the boundaries from 1 – 2 and higher.

DEHNflex M: Compact design; for use in cable duct systems and flush-type boxes

DEHNflex A: For use in any cable duct systems or flush-type boxes; with test function

DEHNflex D: Like DEHNflex A, but for series connection of several socket outlets

As the name suggests, the DEHNflex family offers almost unlimited application options. Being two-pole surge arresters, the compact modules are ideally suited for protecting electronic loads in final circuits. The design was adapted to the most common places of installation, that is cable ducts and flush-type boxes. DEHNflex devices show that small and compact dimensions do not necessarily mean that surge arresters are inefficient. The fault-proof Y protective circuit always ensures safety even if the phase and neutral conductors cannot be identified. Apart from the powerful Y circuit, the compact enclosure also houses a disconnecter and an acoustic fault indicator. Be it in cable ducts, flush-mounted systems, branching boxes or device casings – DEHNflex is always installed in the right place close to terminal equipment.



DEHNflex M

Surge arrester for single-phase 230 V TT and TN systems for use in all installation systems of terminal equipment; compact dimensions.

Type DFL ...	M 255
Part. No.	924 396
SPD according to EN 61643-11 / IEC 61643-11	type 3 / class III
Max. continuous operating voltage (a.c.) (U_c)	255 V (50 / 60 Hz)
Nominal discharge current (8/20 μ s) (I_n)	1.5 kA
Total discharge current (8/20 μ s) [L+N-PE] (I_{total})	3 kA
Voltage protection level [L-N] / [L/N-PE] (U_p)	≤ 1250 / ≤ 1500 V
Max. mains-side overcurrent protection	B 16 A
Fault indication	acoustic signal on
Dimensions	30 x 50 x 11 mm

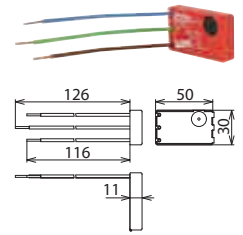

DEHNflex A

Surge arrester for single-phase 230 V TT and TN systems for use in all installation systems of terminal equipment; with test function; compact dimensions.

Type DFL ...	A 255
Part. No.	924 389
SPD according to EN 61643-11 / IEC 61643-11	type 3 / class III
Max. continuous operating voltage (a.c.) (U_c)	255 V (50 / 60 Hz)
Nominal discharge current (8/20 μ s) (I_n)	3 kA
Total discharge current (8/20 μ s) [L+N-PE] (I_{total})	5 kA
Voltage protection level [L-N] / [L/N-PE] (U_p)	≤ 1250 / ≤ 1500 V
Max. mains-side overcurrent protection	B 16 A
Fault indication	acoustic signal on
Dimensions	36 x 46 x 19 mm

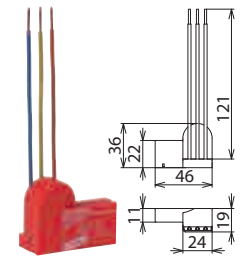

DEHNflex D

Surge arrester for single-phase 230 V TT and TN systems for use in all installation systems of terminal equipment; allows series connection; with test function; compact dimensions.

Type DFL ...	D 255
Part. No.	924 395
SPD according to EN 61643-11 / IEC 61643-11	type 3 / class III
Max. continuous operating voltage (a.c.) (U_c)	255 V (50 / 60 Hz)
Nominal discharge current (8/20 μ s) (I_n)	3 kA
Total discharge current (8/20 μ s) [L+N-PE] (I_{total})	5 kA
Voltage protection level [L-N] / [L/N-PE] (U_p)	≤ 1250 / ≤ 1500 V
Max. mains-side overcurrent protection	B 16 A
Fault indication	acoustic signal on
Dimensions	36 x 46 x 19 mm

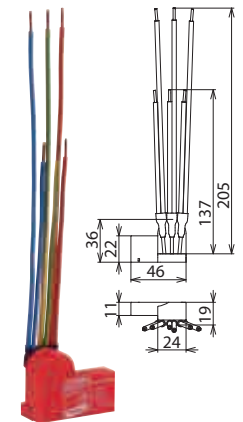



VC 280 2

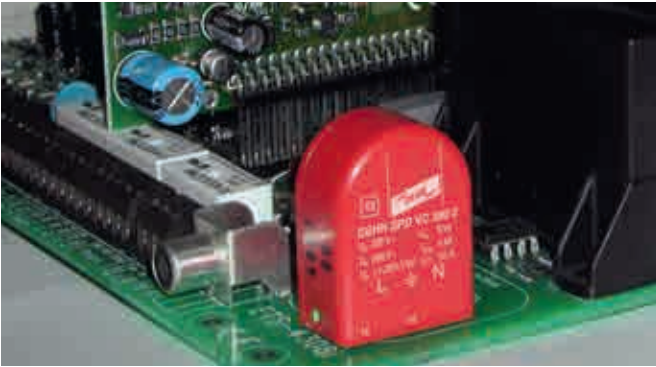

VC 280 2 protects electronic equipment against surges. It is installed in the enclosure or directly in the device to be protected in conformity with the lightning protection zone concept at the boundaries from 1 – 2 and higher. German utility patent.

Compact Protection for Terminal Equipment

- Two-pole surge arrester with monitoring device and disconnector
- Complete surge protection for devices supplied by a.c. voltage
- Enhanced safety due to fault-proof Y protective circuit
- Floating remote signalling contact (break contact) with test option for fault indication
- For installation on printed circuit boards

VC 280 2: Mains module with integrated surge protection for installation in the terminal device to be protected

VC 280 2 surge arresters are small, but no less complex. The two-pole module incorporates a fault-proof Y protective circuit, a monitoring and disconnection device as well as a floating remote signalling contact, thus ensuring compact dimensions and maximum safety. The surge arresters

even feature an integrated test option for the fault indicator. VC 280 2 reliably protects electronic equipment against overvoltage. The solder pins of VC 280 2 surge arresters allow to install them directly on the PCBs of the device to be protected.

VC 280 2

Mains module with integrated surge protection and floating break contact for installation into the terminal equipment to be protected.



Type	VC 280 2
Part. No.	900 471
SPD according to EN 61643-11 / IEC 61643-11	type 3 / class III
Max. continuous operating voltage (a.c.) (U_c)	280 V (50 / 60 Hz)
Nominal discharge current (8/20 μ s) (I_n)	3 kA
Total discharge current (8/20 μ s) [L+N-PE] (I_{total})	5 kA
Voltage protection level [L-N] / [L/N-PE] (U_p)	≤ 1250 / ≤ 1500 V
Max. mains-side overcurrent protection	B 16 A
Fault indication	remote signalling contact (break contact)



DEHNprotector

- Surge protection with monitoring device and disconnector
- Visual operating state (green) and fault indication (red)
- Mains filter (DEHNpro 230 F Protector only)
- Enhanced safety due to fault-proof Y protective circuit



The adapter protects the power supply circuits of electronic equipment against transients and high-frequency interference voltages (DEHNpro 230 F Protector). For installation in conformity with the lightning protection zone concept at the boundaries from 1 – 2 and higher.

DEHNpro 230: Protection of terminal equipment

DEHNpro 230 F: Protection of terminal equipment with mains filter

The adapters with integrated surge protection of the DEHNpro family protect electronic loads connected to final circuits from overvoltage. An interference suppressor filter with a balancing and unbalancing effect was integrated in the powerful surge protective circuit of DEHNpro 230 F Protectors. This combination of surge protection and filter prevents a core saturation of the filter in case of high-level transients. The nominal current carrying capability of 16 A (DEHNpro 230) and 10 A (230 F Protector) allows flexible use of these devices in final circuits. The fault-proof Y circuit ensures protection even if the phase and neutral conductors in standard earthed socket outlets cannot be identified. The integrated disconnector

ensures reliability of devices and installations. The standard green and red LEDs indicate the operating state of the surge protective devices.

The modern design of the DEHNpro devices and the use of high-quality materials ensure safety in a sophisticated appearance. The DEHNpro devices thus ideally adapt to the installation environment. They create the right technical environment already at the socket outlet for connecting the latest communication and multimedia systems. The curved enclosure surfaces and the smooth surface structure ensure that the DEHNpro devices will not lose their original properties even after several years of application.

Further adapters with integrated surge protection for protecting the power supply circuit and the data interface of an electronic device can be found on page 210 – 211.

DPRO 230 Protector

Adapter with integrated surge protection and child lock.

Type DPRO ...	230
Part. No.	909 230
SPD according to EN 61643-11 / IEC 61643-11	type 3 / class III
Max. continuous operating voltage (a.c.) (U_c)	255 V (50 / 60 Hz)
Nominal discharge current (8/20 μ s) (I_n)	3 kA
Total discharge current (8/20 μ s) [L+N-PE] (I_{total})	5 kA
Voltage protection level [L-N] / [L/N-PE] (U_p)	$\leq 1250 / \leq 1500$ V
Max. mains-side overcurrent protection	B 16 A
Fault indication	red light
Operating state indication	green light



DPRO 230 F Protector

Surge protection for terminal devices with integrated mains filter.

Type DPRO ...	230 F
Part. No.	909 240
SPD according to EN 61643-11 / IEC 61643-11	type 3 / class III
Max. continuous operating voltage (a.c.) (U_c)	255 V (50 / 60 Hz)
Nominal discharge current (8/20 μ s) (I_n)	3 kA
Total discharge current (8/20 μ s) [L+N-PE] (I_{total})	5 kA
Voltage protection level [L-N] / [L/N-PE] (U_p)	$\leq 1250 / \leq 1500$ V
Max. mains-side overcurrent protection	B 16 A
Fault indication	red light
Operating state indication	green light





SFL Protector



Multiple socket outlet for protecting the power supply circuits of electronic equipment against transients and high-frequency interference voltages. For installation in conformity with the lightning protection zone concept at the boundaries from 1 – 2 and higher.

- Surge protection with monitoring device and disconnector
- Interference suppressor filter
- Enhanced safety due to fault-proof Y protective circuit
- Mains switch with operating state indication (SFL PRO 6X only)
- 2 m connection cable for flexible use in a wide range of applications
- Visual operating state (green) and fault indicator (red)

SFL PRO 6X: Surge protective multiple socket outlet with interference suppressor filter

SFL PRO 6X 19": Surge protective multiple socket outlet with mains filter for 482.6 mm (19 inch) data cabinets

The SFL Protector surge arrester complements the wide range of Red/Line surge protective devices. The combination of surge protection and mains filter makes the six-way socket outlet a powerful device for protecting electronic loads in final circuits. The harmonised surge protection and filter functions complement one another and prevent core saturation of the filter in case of high-level transients. The integrated mains filter is optimised for protection against balanced and unbalanced high-frequency interferences. The nominal current carrying capability of 16 A allows flexible use of these devices in final circuits.

The fault-proof Y protection circuit ensures protection even if the phase and neutral conductors in standard earthed socket outlets cannot be identified. The standard green and red LEDs indicate the operating state of the surge protective device.

The SFL PRO 6X 19" has been specifically developed for use in network cabinets and therefore provides optimal protection for terminal equipment in this critical field of application.

**SFL PRO 6X**

Surge protective multiple socket outlet with mains filter.

Type SFL PRO ...	6X
Part. No.	909 250
SPD according to EN 61643-11 / IEC 61643-11	type 3 / class III
Max. continuous operating voltage (a.c.) (U_c)	255 V (50 / 60 Hz)
Nominal discharge current (8/20 μ s) (I_n)	3 kA
Total discharge current (8/20 μ s) [L+N-PE] (I_{total})	5 kA
Voltage protection level (U_p)	≤ 1.5 kV
Max. mains-side overcurrent protection	B 16 A
Number of socket outlets	6

**SFL PRO 19"**

Surge protective multiple socket outlet with mains filter for 482.6 mm (19 inches) data cabinets.

Type SFL PRO ...	6X 19"
Part. No.	909 251
SPD according to EN 61643-11 / IEC 61643-11	type 3 / class III
Max. continuous operating voltage (a.c.) (U_c)	255 V (50 / 60 Hz)
Nominal discharge current (8/20 μ s) (I_n)	3 kA
Total discharge current (8/20 μ s) [L+N-PE] (I_{total})	5 kA
Voltage protection level (U_p)	≤ 1.5 kV
Max. mains-side overcurrent protection	B 16 A
Number of socket outlets	6





DEHNpanel

- Remote visual indicator for surge protective devices (SPDs)
- Easy installation
- For installation in switchgear doors
- Low energy consumption due to current-saving LEDs
- Supplied by two AA batteries
- Easy battery replacement without opening the switchgear door
- Wire breakage detection by connecting the break contact of the remote signalling contact



Visual indicator for surge protective devices installed in switchgear cabinets.

DEHNpanel remotely indicates the status of surge protective devices with remote signalling contact in a switchgear installation.

High-luminosity LEDs clearly indicate the status of the surge protective device even under difficult lighting conditions. DEHNpanel can be easily integrated into existing switchgear installations, allowing the operator of

the installation to easily test the surge protective devices installed without opening the switchgear cabinet.

The current-saving LEDs ensure a long battery service life of several years. Batteries can be replaced by ordinary persons since the switchgear cabinet does not have to be opened.

DPAN L

Visual indicator for surge protective devices installed in switchgear cabinets.

Type	DPAN L
Part No.	910 200
Voltage supply	2x 1.5 V lithium batteries, size AA
Operating state / fault indication	green LED (flashing) / red LED (flashing)
Flashing frequency	0.1 s on / 1.3 s off
Degree of protection (front / rear side)	IP 40 / IP 20
Mounting dimensions	92 x 45 mm
Dimensions	96 x 48 x 75 mm





Wiring Accessories DK



- Allows to change the wiring level
- For lightning-current-conform installation of arrester combinations

Uniform wiring level from the top thanks to DK 25 feed-through terminal.

Feed-Through Terminal DK 25

Feed-through terminal for busbar wiring.



Type	DK 25
Part No.	952 699
Nominal voltage (a.c. / d.c.) (U _N)	500 V
Nominal load current (a.c.) (I _N)	100 A
Lightning impulse current (10/350 μs)	100 kA
Cross-sectional area (min.)	1.5 mm ² solid / flexible
Cross-sectional area (max.)	25 mm ² stranded / 16 mm ² flexible



Wiring Accessories STAK

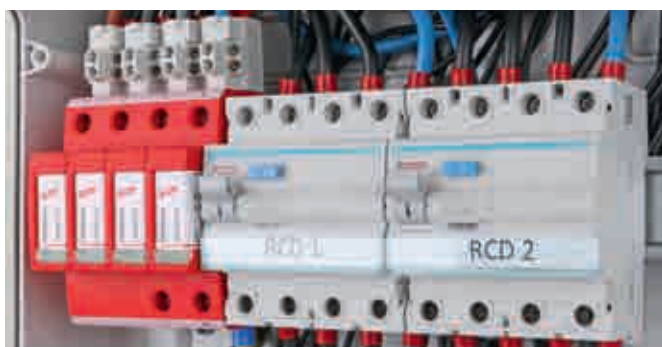

STAK 3X16 for EMC-optimized series connection of string lines in a PV generator junction box.

- EMC-optimized series connection according to IEC 60364-5-53



STAK 2X16 for EMC-optimized series connection of lightning current and surge arresters according to IEC 60364-5-53.

STAK 25 Pin-shaped Terminal

Pin-shaped terminal for EMC-optimized series connection of lightning current and surge arresters according to IEC 60364-5-53.



Type STAK ...	25
Part No.	952 589
Nominal voltage (a.c. / d.c.) (U _N)	600 V
Max. PV voltage (U _{CPV}) when used in combination with DEHNguard M YPV SCI ...	1200 V
Lightning impulse current (10/350 μs)	25 kA
Discharge current (8/20 μs)	50 kA
Cross-sectional area (min.)	1.5 mm ² solid / flexible
Cross-sectional area (max.)	25 mm ² stranded / 16 mm ² flexible
Type of connection	front

STAK 2X16 Pin-shaped Terminal

Pin-shaped terminal for EMC-optimized series connection of lightning current and surge arresters according to IEC 60364-5-53.



Type STAK ...	3X16	2X16
Part No.	900 588 ^{NEW}	900 589
Nominal voltage (a.c. / d.c.) (U _N)	690 V / 1000 V	
Lightning impulse current (10/350 μs)	25 kA	25 kA
Cross-sectional area (min.)	1.5 mm ² solid / flexible	2x 1.5 mm ²
Cross-sectional area (max.)	16 mm ² stranded / 10 mm ² flexible	2x max. 16 mm ²
Type of connection	front	front (double terminal)

Insulating Enclosures

- Lightning-impulse-current-tested insulating enclosure for arresters

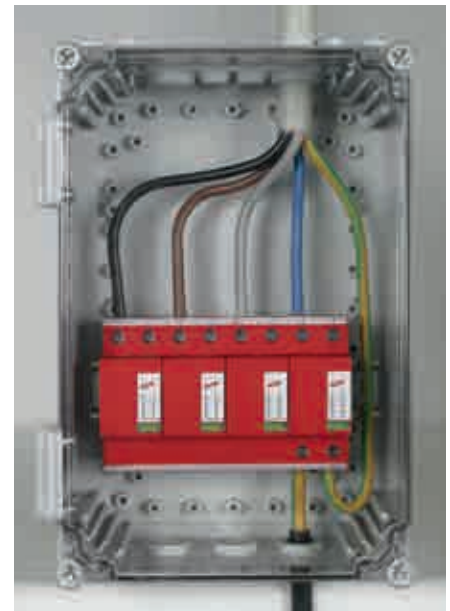

Application example: Modular DEHNventil M TNS installed in an IGA 10 V2 IP54 insulating enclosure.

IGA 10 V2 IP54

Lightning-current-tested insulating enclosure with a max. capacity of ten modules; with grommet flange for 11 EPDM cables (Ø5-30 mm) and three mounted M20 grommet openings with lock nut; ideally suited for series connection.

Type IGA ...	10 V2 IP54
Part No.	902 315
Degree of protection	IP 54
Type	lightning-current-tested
Number of cable entries	4x for cables Ø5-7mm; 3x for cables Ø7-10 mm; 2x for cables Ø10-14 mm or Ø15-30 mm each; 3x for cables Ø8-13 mm
Capacity	10 modules, DIN 43880
Dimensions (W x H x D)	200 x 300 x 132 mm
Cover	sealable



IGA 7 IP54

Lightning-current-tested insulating enclosure with a max. capacity of seven modules; with EPDM grommet flange for two cables (Ø1-25 mm) and three mounted M20 grommet openings with lock nut; ideally suited for series connection.

Type IGA ...	7 IP54
Part No.	902 314
Degree of protection	IP 54
Type	lightning-current-tested
Number of cable entries	2x for cables Ø1-25 mm; 3x for cables Ø8-13 mm
Capacity	7 modules, DIN 43880
Dimensions (W x H x D)	175 x 250 x 100 mm
Cover	sealable



IGA 6 IP54

Lightning-current-tested insulating enclosure with a max. capacity of six modules for non-exhausting arresters; with knockouts for entering the cables and plug-in glands; ideally suited for series connection.

Type IGA ...	6 IP54
Part No.	902 485
Degree of protection	IP 54
Type	lightning-current-tested
Number of cable entries	2 plug-in glands for cables Ø8-23 mm (M32 knockout)
Capacity	6 modules, DIN 43880
Dimensions (W x H x D)	165 x 255 x 115 mm
Cover	sealable



IGA 12 IP54

Insulating enclosure with a max. capacity of 12 modules for non-exhausting arresters; with integrated elastic sealing grommet for entering the cables; ideally suited for series connection.



Type IGA ...	12 IP54
Part No.	902 471
Degree of protection	IP 54
Number of cable entries	8x for cables Ø7-12 mm; 8x for cables Ø7-14 mm; 4x for cables Ø12-20 mm; 1x for cables Ø16.5-29 mm (top and bottom)
PE / N quantity x cross-section	3x 25 mm ² , 12x 4 mm ² , Cu
Capacity	12 modules, DIN 43880
Dimensions (W x H x D)	295 x 333 x 129 mm

IGA 12 IP65

Lightning-current-tested insulating enclosure with a max. capacity of 12 modules for non-exhausting arresters; with integrated elastic sealing grommet for entering the cables; ideally suited for series connection.



Type IGA ...	12 IP65
Part No.	902 316
Degree of protection	IP 65
Type	lightning-current-tested
Number of cable entries	8x for cables Ø7-12 mm; 8x for cables Ø7-14 mm; 4x for cables Ø12-20 mm; 1x for cables Ø16.5-29 mm (top and bottom)
PE / N quantity x cross-section	3x 25 mm ² , 12x 4 mm ² , Cu
Capacity	12 modules, DIN 43880
Dimensions (W x H x D)	295 x 333 x 129 mm

IGA 24 IP54

Insulating enclosure with a max. capacity of 2x 12 modules for non-exhausting arresters; with integrated elastic sealing grommet for entering the cables; ideally suited for series connection.



Type IGA ...	24 IP54
Part No.	902 472
Degree of protection	IP 54
Number of cable entries	8x for cables Ø7-12 mm; 8x for cables Ø7-14 mm; 4x for cables Ø12-20 mm; 1x for cables Ø16.5-29 mm (top and bottom)
PE / N quantity x cross-section	6x 25 mm ² , 24x 4 mm ² , Cu
Capacity	24 modules (2x 12 modules), DIN 43880
Dimensions (W x H x D)	295 x 458 x 129 mm

Accessories for Insulating Enclosures

Sealing Device

For sealing between the lower and upper part of IGA 12 and IGA 24 insulating enclosures (doors can be sealed without additional part).



Type	PLOV IGA 12 24
Part No.	902 317
Material	aluminium

Busbars / Modular Wiring System

- Allows compact connection of arresters with each other and with other DIN rail mounted devices

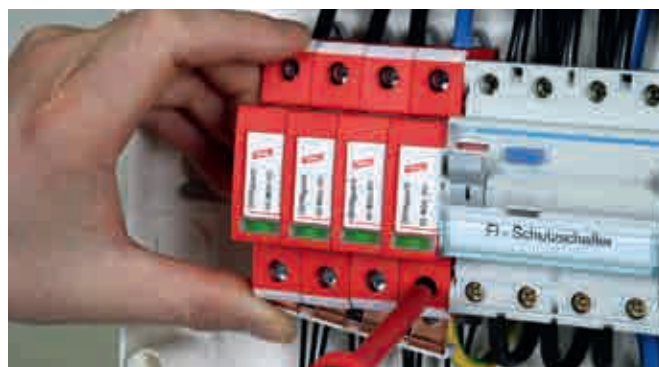
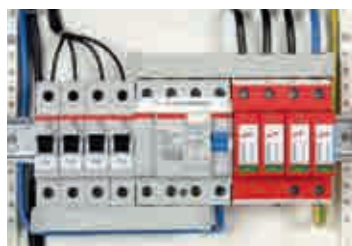

MVS single-phase, two-pole

For connecting the earth terminal of e.g. 2 DEHNguard S surge arresters to earth.

Type	MVS 1 2
Part No.	900 617
Type	single-phase
Number of contact studs	2
Max. installation length	2 module(s)
Nominal cross-section	16 mm ²



MVS single-phase, three-pole

For connecting the earth terminal of e.g. 3 DEHNguard S surge arresters to earth.

Type	MVS 1 3
Part No.	900 615
Type	single-phase
Number of contact studs	3
Max. installation length	3 module(s)
Nominal cross-section	16 mm ²



MVS single-phase, four-pole

For connecting the earth terminal of e.g. 4 DEHNguard S surge arresters to earth.

Type	MVS 1 4
Part No.	900 610
Type	single-phase
Number of contact studs	4
Max. installation length	4 module(s)
Nominal cross-section	16 mm ²



MVS single-phase, six-pole

For connecting the earth terminal of e.g. 3 type 1 SPDs with two-module enclosure to earth.

Type	MVS 1 6
Part No.	900 815
Type	single-phase
Number of contact studs	6
Max. installation length	6 module(s)
Nominal cross-section	16 mm ²

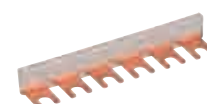

MVS single-phase, seven-pole

For connecting the earth terminal of e.g. 3 DEHnbloc Maxi and 1 DEHNgap Maxi in 3+1 configuration to earth.

Type	MVS 1 7
Part No.	900 848
Type	single-phase
Number of contact studs	7
Max. installation length	7 module(s)
Nominal cross-section	16 mm ²

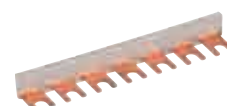

MVS single-phase, eight-pole

For connecting the earth terminal of e.g. 4 DEHNbloc Maxi lightning current arresters to earth.

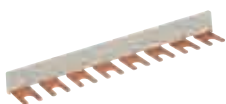

Type	MVS 1 8
Part No.	900 611
Type	single-phase
Number of contact studs	8
Max. installation length	8 module(s)
Nominal cross-section	16 mm ²

MVS single-phase, 57-pole

For connecting the earth terminal of lightning current and surge arresters or combinations thereof to earth.



Type	MVS 1 57
Part No.	900 612
Type	single-phase
Number of contact studs	57
Max. installation length	57 module(s)
Nominal cross-section	16 mm ²

MVS three-phase, six-pole, 6 Modules

For phase-side connection of surge arresters.

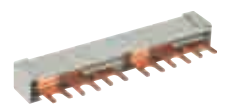

Type	MVS 3 6 6
Part No.	900 595
Type	three-phase
Number of contact studs	6
Max. installation length	6 module(s)
Nominal cross-section	16 mm ²

MVS three-phase, six-pole, 8 Modules

For phase-side connection of DIN rail mounted devices to DEHNventil M TNC.

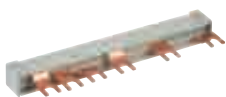

Type	MVS 3 6 8
Part No.	900 813
Type	three-phase
Number of contact studs	6
Max. installation length	8 module(s)
Nominal cross-section	16 mm ²

MVS three-phase, six-pole, 9 Modules

For phase-side connection of three-pole surge arresters to fuse holders (for 1.5-module enclosures).



Type	MVS 3 6 9
Part No.	900 839
Type	three-phase
Number of contact studs	6
Max. installation length	9 module(s)
Nominal cross-section	16 mm ²

MVS four-phase, eight-pole

For phase-side connection of DIN rail mounted devices to DEHNventil M TNS and TT.

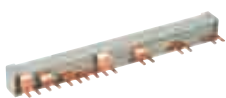

Type	MVS 4 8 11
Part No.	900 814
Type	four-phase
Number of contact studs	8
Max. installation length	11 module(s)
Nominal cross-section	16 mm ²

MVS four-phase, 56-pole

For phase-side connection of surge arresters.

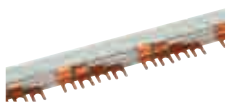

Type	MVS 4 56
Part No.	900 614
Type	four-phase
Number of contact studs	56
Max. installation length	56 module(s)
Nominal cross-section	16 mm ²

Earthing Clip for 1.5-module Enclosures, single-phase, two-pole

Earthing clip for connecting e.g. two SPDs with 1.5-module enclosure, with terminal.

Type	EB 1 2 1.5
Part No.	900 460
Type	single-phase
Number of contact studs	2
Dimensions	34 x 60 x 28 mm
Material	copper and tin-plated brass
Terminal	up to 25 mm ²



Earthing Clip for 1.5-module Enclosures, single-phase, three-pole

Earthing clip for connecting e.g. three SPDs with 1.5-module enclosure, with terminal.

Type	EB 1 3 1.5
Part No.	900 418
Type	single-phase
Number of contact studs	3
Dimensions	34 x 85 x 28 mm
Material	copper and tin-plated brass
Terminal	up to 25 mm ²



Earthing Clip for 1.5-module Enclosures, single-phase, four-pole

Earthing clip for connecting e.g. four SPDs with 1.5-module enclosure, with terminal.

Type	EB 1 4 1.5
Part No.	900 429
Type	single-phase
Number of contact studs	4
Dimensions	34 x 112 x 28 mm
Material	copper and tin-plated brass
Terminal	up to 25 mm ²



Earthing Clip for two-module Enclosures, single-phase, two-pole

Earthing clip for connecting e.g. two SPDs with two-module enclosure, with terminal.

Type	EB 1 2 5
Part No.	900 419
Type	single-phase
Number of contact studs	2
Dimensions	34 x 77 x 28 mm
Material	copper and tin-plated brass
Terminal	up to 25 mm ²



Earthing Clip for two-module Enclosures, single-phase, three-pole

Earthing clip for connecting e.g. three SPDs with two-module enclosure, with terminal.

Type	EB DG 1000 1 3
Part No.	900 411
Type	single-phase
Number of contact studs	3
Dimensions	34 x 112 x 28 mm
Material	copper and tin-plated brass
Terminal	up to 25 mm ²



Earthing Clip for two-module Enclosures, single-phase, four-pole

Earthing clip for connecting e.g. four SPDs in a two-module enclosure, with terminal.

Type	EB 1 4 9
Part No.	900 417
Type	single-phase
Number of contact studs	4
Dimensions	34 x 148 x 28 mm
Material	copper and tin-plated brass
Terminal	up to 25 mm ²



Earthing Clip for three-module Enclosures, single-phase, three-pole

Earthing clip for connecting e.g. three SPDs with three-module enclosure, with terminal.



Type	EB 1 3 10
Part No.	900 461
Type	single-phase
Number of contact studs	3
Dimensions	34 x 158 x 28 mm
Material	copper and tin-plated brass
Terminal	up to 25 mm ²

Earthing Clip for three-module Enclosures, single-phase, four-pole

Earthing clip for connecting e.g. four SPDs with three-module enclosure, with terminal.



Type	EB 1 4 13
Part No.	900 462
Type	single-phase
Number of contact studs	4
Dimensions	34 x 212 x 28 mm
Material	copper and tin-plated brass
Terminal	up to 25 mm ²



Impulse Counter



Registration of discharge processes

- Potential-free registration of discharge currents occurred in surge protective devices
- Easy installation by enclosing the earthing conductor of the arrester with a hinged toroidal core
- Counter in a DIN rail mounted enclosure (2 modules)
- Twisted sensor cable, 1 m long

Counter with LCD and integrated battery supply (3 V) and battery charge control. Indication of lightning discharges with date and time.

Impulse counter P3: Counter, sensor cable and toroidal core



Type	IPC P3
Part No.	910 512
Response threshold for impulse currents (rise time $\geq 8 \mu\text{s}$)	1 kA
LCD display	electronic counter 0-999
Power supply	3 V lithium battery (CR123A) included in delivery, replaceable, battery life of 3 years
Setting device	button on the device for setting the counter (e.g. after replacing a battery)
Resetting device	button on the device for resetting the counter to 0
Dimensions (sensor)	inner \varnothing : 14 mm
Accessories included in delivery	3 V lithium battery (CR123A); cable tie (for fixing the sensor)



SPD Test Device

- For routine tests of surge protective devices
- Compact dimensions
- Suitable for mains and battery operation
- Low battery indicator
- Test leads included in delivery



For testing the sparkover voltage of surge arresters. The specimen is connected via the included test leads or special test adapters.

The PM 20 SPD test device with integrated detection of the sparkover voltage is used to test Red/Line and Yellow/Line surge arresters with integrated varistor, Zener diode or gas discharge tube. Both the sparkover performance between the connections of the arresters as well as the con-

tinuity can be tested. The results can be compared to the limit values specified in the instructions for use. In case of deviations, the arrester or protection module must be replaced.



Indication of the measured sparkover voltage.

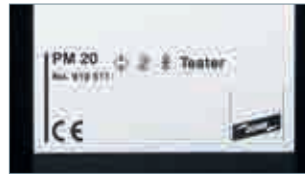

The sparkover performance of gas discharge tubes, varistors and Zener diodes can be tested.



Insulated test leads included in delivery.



Can be directly connected to a DEHN-guard protection module.

PM 20

Combined device for testing the sparkover voltage of surge arresters (with gas discharge tubes/varistors/Zener diodes). Storage bag and measuring accessories included.

Type	PM 20
Part No.	910 511
Nominal voltage (U _N)	8-12 V d.c.
Test parameter: Test voltage	max. 1250 V d.c.
Test parameter: Test current (reference voltage)	1 mA d.c., constant
Measured value indication	alphanumeric, eight-digit LCD
Accessories included in delivery	2 test leads (each 1 m long), 2 safety tapping test clips, 1 plug-in power supply unit (230 V a.c.), 1 storage bag





Are you missing a Red/Line Surge Protection Product? Here you will find the relevant successor:

Outdated Part No.	Type	Current Product Part No.	Type
Combined Arresters – Type 1			
900 330	DLM PV 1000	900 061	DCB YPV SCI 1000
		900 066	DCB YPV SCI 1000 FM
900 342	DLM PV 1000 V2	—	
900 345	DLM PV 100 V2 FM	—	
900 370	DV 2P TT 255	951 110	DV M TT 2P 255
		951 115	DV M TT 2P 255 FM
900 371	DV 2P TN 255	951 200	DV M TN 255
		951 205	DV M TN 255 FM
900 373	DV TNC 255	951 300	DV M TNC 255
		951 305	DV M TNC 255 FM
900 374	DV TNS 255	951 400	DV M TNS 255
		951 405	DV M TNS 255 FM
900 375	DV TT 255	951 310	DV M TT 255
		951 315	DV M TT 255 FM

Outdated Part No.	Type	Current Product Part No.	Type
Coordinated Lightning Current Arresters – Type 1			
900 015	DBM 1 135	961 110	DB M 1 150
		961 115	DB M 1 150 FM
900 016	DBM 1 320	961 130	DB M 1 320
		961 135	DB M 1 320 FM
900 025	DBM 1 255	961 120	DB M 1 255
900 026	DBM 1 255 L	961 125	DB M 1 255 FM
900 044	DBM 440	961 140	DBM 1 440
		961 145	DBM 1 440 FM
900 055	DGPM 255	961 101	DGP M 255
		961 105	DGP M 255 FM

Outdated Part No.	Type	Current Product Part No.	Type
Lightning Current Arresters – Type 1			
900 110	DB 3 255	900 120	DB 3 255 H
900 111	DB 1 255	900 222	DB 1 255 H
900 132	DGP BN 255	961 102	DGPH M 255
900 159	DB 1 440	961 140	DBM 1 440
		961 145	DBM 1 440 FM
900 269	DGP B NH00 N 255	—	
900 273	DB NH00 255 H	900 255	DBM NH00 255

Outdated Part No.	Type	Current Product Part No.	Type
Surge Arresters – Type 2			
900 133	DGP C T 255	952 030	DGP C S
		952 035	DGP C S FM
900 506	DG TN 230	952 200	DG M TN 275
900 507	DG TN 230 FM	952 205	DG M TN 275 FM
900 508	DG TT 230	952 110	DG M TT 2P 275
900 509	DG TT 230 FM	952 115	DG M TT 2P 275 FM
900 510	DG TNC 230 400	952 300	DG M TNC 275
900 516	DG IT 500	952 302	DG M WE 600
900 517	DG Y PV 1000	952 510	DG M YPV SCI 1000
		952 511	DG M YPV SCI 600
900 520	DG TT 230 400	952 310	DG M TT 275
900 530	DG TNS 230 400	952 400	DG M TNS 275
900 540	DG TNC 230 400 FM	952 305	DG M TNC 275 FM
900 546	DG IT 500 FM	952 307	DG M WE 600 FM
900 547	DG Y PV 1000 FM	952 515	DG M YPV SCI 1000 FM
		952 516	DG M YPV SCI 600 FM
900 550	DG TT 230 400 FM	952 315	DG M TT 275 FM
900 560	DG TNS 230 400 FM	952 405	DG M TNS 275 FM
900 600	DG 275	952 070	DG S 275
900 601	DG 600	952 076	DG S 600
900 602	DG 385	952 074	DG S 385
900 603	DG 150	952 072	DG S 150
900 604	DG 75	952 071	DG S 75
900 605	DG 320	952 073	DG S 320
900 607	DG 440	952 075	DG S 440
900 620	DG 275 FM	952 090	DG S 275 FM
900 621	DG 600 FM	952 096	DG S 600 FM

Outdated Part No.	Type	Current Product Part No.	Type
900 622	DG 385 FM	952 094	DG S 385 FM
900 623	DG 150 FM	952 092	DG S 150 FM
900 624	DG 75 FM	952 091	DG S 75 FM
900 625	DG 320 FM	952 093	DG S 320 FM
900 627	DG 440 FM	952 095	DG S 440 FM
900 641	DG T 385	952 074	DG S 385
900 650	DG T 275	952 070	DG S 275
900 651	DG T 600	952 076	DG S 600
900 652	DG T 320	952 073	DG S 320
900 653	DG T 150	952 072	DG S 150
900 654	DG T 75	952 071	DG S 75
900 655	DG T 440	952 075	DG S 440
900 659	DG T 275 VA	952 082	DG S 275 VA
900 667	DG T 75 VA	952 080	DG S 75 VA
900 680	DG T 275 FM	952 090	DG S 275 FM
900 681	DG T 600 FM	952 096	DG S 600 FM
900 682	DG T 320 FM	952 093	DG S 320 FM
900 683	DG T 150 FM	952 092	DG S 150 FM
900 684	DG T 75 FM	952 091	DG S 75 FM
900 685	DG T 440 FM	952 095	DG S 440 FM
900 689	DG T 275 VA FM	952 087	DG S 275 VA FM
900 691	DG T 385 FM	952 094	DG S 385 FM
900 692	DG T 75 VA FM	952 085	DG S 75 VA FM
950 120	DG T H 275 LI	952 930	DG SE H LI 275 FM
950 121	DG T H 385 LI	952 934	DG SE H LI 385 FM
950 150	DG TT H 230 400 LI	953 930 (3x)	DG SE H LI 275 FM
		952 035 (1x)	DGP C S FM
950 151	DG TT H230 400 LI385	—	
950 160	DG TNC H230 400 LI	952 930 (3x)	DG SE H LI 275 FM
950 170	DG TNS H230 400 LI	952 930 (4x)	DG SE H LI 275 FM
950 220	DG T 48	952 078	DG S 48
950 225	DG T 48 FM	952 098	DG S 48 FM

Outdated Part No.	Type	Current Product Part No.	Type
Surge Arresters – Type 3			
901 100	DR 230 FML	953 205	DR M 2P 255 FM
		953 200	DR M 2P 255
901 101	DR 120 FML	953 209	DR M 2P 150 FM
		953 204	DR M 2P 150
901 102	DR 60 FML	953 208	DR M 2P 75 FM
		953 203	DR M 2P 75
901 103	DR 48 FML	953 207	DR M 2P 60 FM
		953 202	DR M 2P 60
901 104	DR 24 FML	953 206	DR M 2P 30 FM
		953 201	DR M 2P 30
901 130	DR 230 3N FML	953 405	DR M 4P 255 FM
		953 400	DR M 4P 255
909 820	SF PRO	909 240	DPRO 230 F
909 821	S PRO	909 230	DPRO 230
912 260	SFL PRO	909 250	SFL PRO 6X
924 339	NSM PRO AZ	—	
924 340	AR1 AZ	—	
924 342	NSM PRO EW	—	
924 343	AR1 EW	—	

Outdated Part No.	Type	Current Product Part No.	Type
General Accessories			
900 309	IGA 10 IP54	902 315	IGA 10 V2 IP54
902 480	IGA 10 IP55	902 315	IGA 10 V2 IP54
900 699	DK 35	952 699	DK 25
910 600	DISO 3	—	

Outdated Part No.	Type	Current Product Part No.	Type
Isolating Spark Gaps			
923 070	EXFS C1	923 100	EXFS 100
923 071	EXFS C1 KU	923 101	EXFS 100 KU

Surge Protection for INFORMATION TECHNOLOGY SYSTEMS

SPDs for Installations and Devices



Yellow / Line

SPDs for Information Technology Systems



The surge protection components of arresters do not contain any radioactive isotopes and typically consist of at least one voltage-limiting or voltage-switching component and, in some cases, also of additional overcurrent-limiting components. The occurrence of blind spots in multistage arresters must be prevented. This means that it must be ensured that the different protection stages are fully coordinated with one another. Otherwise the protection stages will not reliably trip and cause faults in the protective device.

Arrester selection

The following must be observed when selecting arresters:

- Protective effect
[Yellow/Line SPD class (discharge capacity and voltage protection level)]
- System parameters
(system voltage, nominal current and transmission parameters)
- Installations environment
(design, connection conditions and approvals)

The selection guide according to interface/signal on pages 135 – 155 facilitates the selection of an adequate arrester.

Relevant product standard for arresters:

IEC/DIN EN 61643-21

Low-voltage surge protective devices – Part 21: Surge protective devices connected to telecommunications and signalling networks – Performance requirements and testing methods.

Discharge capacity

According to IEC/DIN EN 61643-21 arresters must be tested with at least one impulse voltage and impulse current from the above table with the specified quantity of impulses. Further tests may be performed – even with different impulse values or quantities. The max. voltage level measured during the test(s) at the output of the device is specified as voltage protection level U_p . Category C represents particularly interference pulses with a steep rate of rise and low energy, while interference pulses of category D are supposed to simulate high energy loads caused by injected partial lightning currents. The relevant category is specified in the technical data of the arresters [see discharge capacity (I_n , I_{imp}) and voltage protection level (U_p)].

Category	Type of test	Impulse voltage	Impulse current	Minimum quantity of impulses	Test for
C1	fast rate of rise	0.5 kV to 2 kV, 1.2/50 μ s	0.25 kA to 1 kA, 8/20 μ s	300	Surge arrester
C2		2 kV to 10 kV, 1.2/50 μ s	1 kA to 5 kA, 8/20 μ s	10	
C3		≥ 1 kV, 1 kV/ μ s	10 A to 100 A, 10/1000 μ s	300	
D1	high energy	≥ 1 kV	0.5 kA to 2.5 kA, 10/350 μ s	2	*)

*) Lightning current arrester / Combined lightning current and surge arrester

Impulse voltages and currents (preferred values) for determining the voltage-limiting characteristics (excerpt from Table 3 of IEC / EN 61643-21)

Immunity of terminal equipment to be protected

During electromagnetic compatibility (EMC) tests, electrical and electronic equipment (devices) must have a certain immunity to conducted interferences (surges). The requirements on the immunity and the test set-up are described in IEC/EN 61000-4-5.

Since the devices are used in different electromagnetic environments, they must have different immunities. The immunity of a device depends on the test level. To classify the different immunities of terminal equipment, test levels are subdivided into four different levels (1 to 4). Test level 1 places the lowest requirement on the immunity of terminal equipment. The test level is specified in the arrester documentation or can be requested from the manufacturer of the arrester.

Test levels 1 – 4 according to EN 61000-4-5	Corresponds to the charging voltage of the test generator
1	0.5 kV
2	1 kV
3	2 kV
4	4 kV

Protective effect of arresters

Yellow/Line arresters for use in information technology systems are capable of limiting conducted interference to a safe level so that the immunity of the terminal equipment is not exceeded. For example, an arrester with a let-through value below the EMC test values of the terminal device must be selected for a terminal device tested with test level 2: Impulse voltage < 1 kV in combination with an impulse current of some amperes (depending on the coupling network).



General

130

Auswahlhilfe nach

Systeme und MSB-Technik	Montage	Ex	Anschlusstechnik	protektionsklasse	Überspannung	Überspannungskategorie	Überspannungskategorie
Schalttafel / Signal			Schraubklemmen	4	●	II	II
BACnet MS/TP			Schraubklemmen	2	●	II	II
			Schraubklemmen	4	●	II	II
			Schraubklemmen	2	●	II	II
			Federklemmen	2	●	II	II
			Federklemmen	20	●	II	II
			USA	4	●	II	II
			Schraubklemmen	2	●	II	II
			Schraubklemmen	4	●	II	II

Easy Choice according to Interface / Signal

135



Pluggable SPDs – DIN Rail mounted
BLITZDUCTOR XT/XTU/SP

157



Terminal Block SPDs – DIN Rail mounted
DEHNconnect SD2

177



Compact SPDs – DIN Rail mounted
DEHNvario, BLITZDUCTOR VT

181

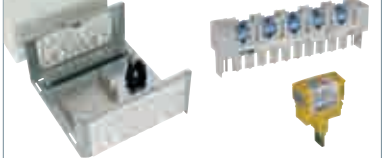

SPDs for LSA Technology
DEHNrapid LSA

187



SPDs for Field Devices
DEHNpipe

197



SPDs for Telecommunication and Data Networks
DEHNpatch, NET PRO

203



SPDs for Building Systems
DEHNprotector, DEHNbox, BUSstector, DEHNlink

209

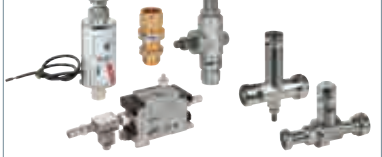

SPDs for Coaxial Connection
UGKF, DEHNgate

217



SPDs for SUB-D Connection
FS

223



Shield Connection Systems and Enclosures

225



Measuring and Test Devices
DEHNrecord

231

Yellow/Line SPD Classes – Symbols

All SPDs of the Yellow/Line family for use in information technology systems are assigned to a Yellow/Line SPD class and marked with a symbol in the technical data sheet and on their rating plates. The symbol for the Yellow/Line SPD class graphically combines three important characteristics of the SPD and can be a single symbol or a combination of individual symbols:

Characteristics	Single symbol	Definition
Discharge capacity of an SPD (according to the categories from IEC/EN 61643-21)	TYPE 1	Impulse D1 (10/350), lightning impulse current ≥ 2.5 kA/line or ≥ 5 kA/total • exceeds the discharge capacity of TYPE 2 – TYPE 4
	TYPE 2	Impulse C2 (8/20), increased impulse load ≥ 2.5 kA/line or ≥ 5 kA/total • exceeds the discharge capacity of TYPE 3 – TYPE 4
	TYPE 3	Impulse C1 (8/20), impulse load ≥ 0.25 kA/line or ≥ 0.5 kA/total • exceeds the discharge capacity of TYPE 4
	TYPE 4	Load $<$ TYPE 3
Protective effect of an SPD (limitation below the test levels according to EN 61000-4-5)	P1	Required test level of the terminal device: 1 or higher
	P2	Required test level of the terminal device: 2 or higher
	P3	Required test level of the terminal device: 3 or higher
	P4	Required test level of the terminal device: 4
Energy coordination (with another Yellow/Line SPD)	+	SPD with decoupling impedance, suitable for coordination with an SPD marked with ⊔
	⊔	SPD is suitable for coordination with an SPD with decoupling impedance +

Examples of energy-coordinated SPDs according to the Yellow/Line SPD class:

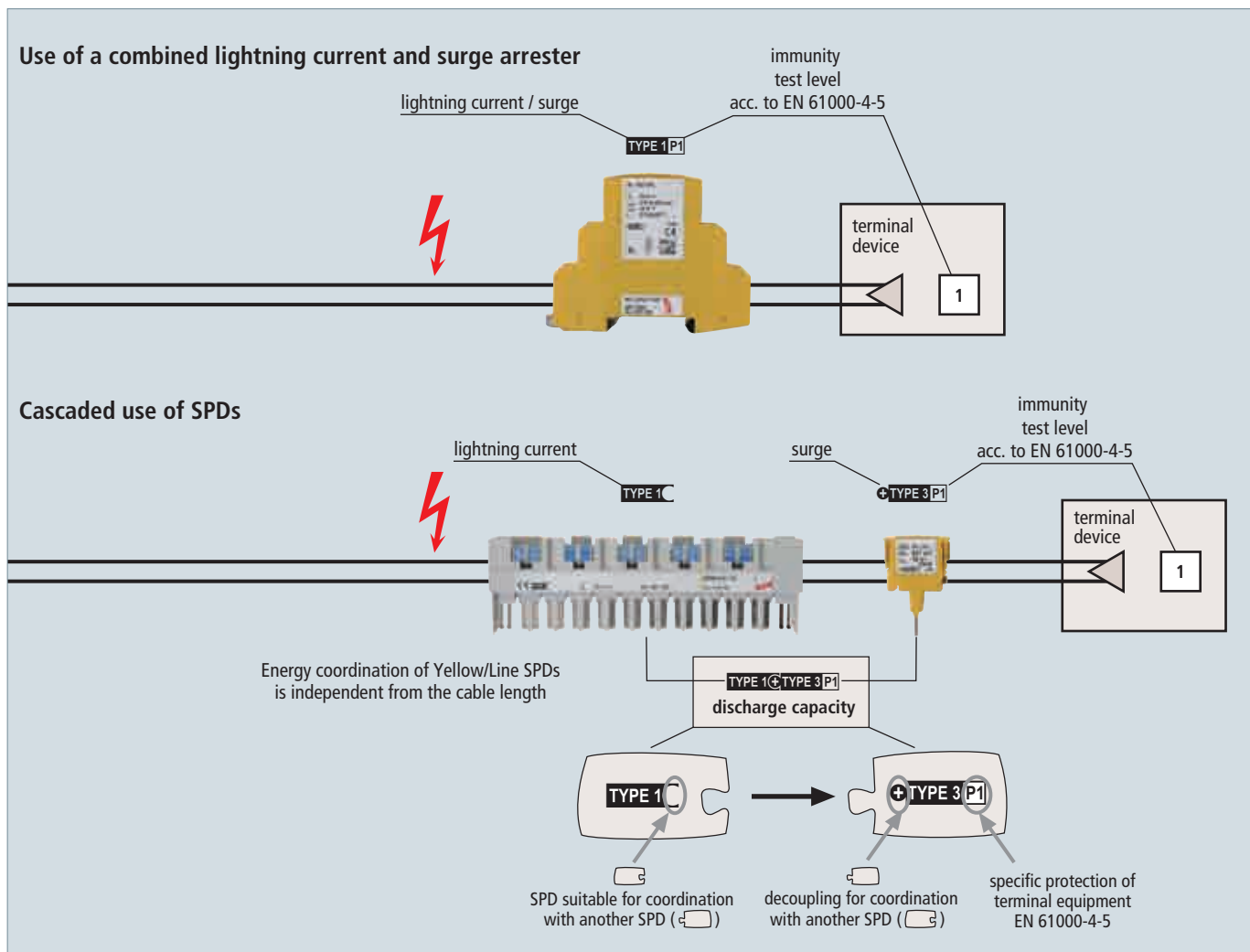

LifeCheck® SPD Test

SPD diagnostics with early warning function!

- Increased protection and availability of your installations and systems due to integrated LifeCheck monitoring system
 - Integrated three-stage monitoring of all protective circuit components
 - Quick diagnostics of surge protective devices
 - Easy testing of protection modules without downtime via contactless RFID technology
 - Even detects pre-damaged arresters



Testing a protection module via a hand-held device based on RFID technology (LifeCheck).

Regular testing of arresters installed

During operation, an arrester may be overloaded by discharge processes exceeding the arrester specification. In order to ensure high system availability, it is therefore essential to test arresters on a regular basis. DIN EN 62305-3, supplement 3 (see table excerpt), specifies the maximum intervals between tests of external and internal lightning protection systems.

Class of LPS	Visual inspection	Complete inspection	Complete inspection of critical systems
I and II	1 year	2 years	1 year
III and IV	2 years	4 years	1 year

Easy testing with LifeCheck

Maintenance of LifeCheck-equipped BLITZDUCTOR XT arresters is particularly easy. LifeCheck uses modern RFID (Radio Frequency Identification) technology for monitoring the protective circuit and for communication. Irrespective of system downtimes, LifeCheck allows quick and easy testing of arresters by means of the hand-held DRC LC M1+ and DRC LC M3+ reader or a stationary DRC SCM XT and DRC MCM XT condition monitoring unit.

Indication of arrester failure

The three-stage LifeCheck monitoring circuit with early warning function detects extreme electrical or thermal stress on all protection elements of an arrester below their destruction limit. This can be contactlessly read out within a matter of seconds by means of an RFID reader. If the reader displays "LifeCheck OK", no extreme stress was detected. If the contrary is the case, the module should be replaced as soon as possible in order not to threaten the availability of the protected circuit.

Functional principle of the LifeCheck diagnostics systems

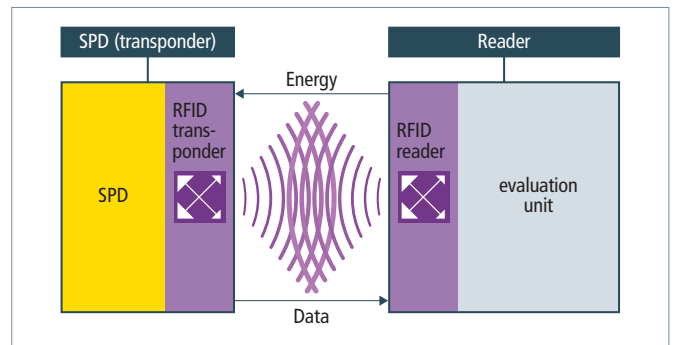

Principle of communication between an arrester and a test device

The diagnostics system consists of two functional units:

- 1. RFID reading and signalling unit (reader)**
 Combined with a visual or electric indicator, an electronic system contactlessly transmits energy to the RFID transponder in the arrester via an antenna. If the operating state of the arrester can be read out, an "OK" message is displayed.
- 2. Monitoring unit in the arrester:**
 It combines the diagnostics of the three-stage LifeCheck monitoring circuit with the communication of the RFID transponder:
 - Diagnostics of electrical overload (impulse current)
 Lightning strikes or overvoltage exceeding the specified discharge capacity of the arrester will damage or even destroy the protection elements. The LifeCheck monitoring device detects this electrical overload. When reading out the transponder, the "Replace SPD!" message appears.
 - Diagnostics of thermal overload (overheating)
 Active and passive protection elements in a critical temperature range will be pre-damaged or even destroyed depending on the type and duration of the overload. This pre-damage or overload is detected by the LifeCheck monitoring device. When reading out the transponder, the "Replace SPD!" message appears.

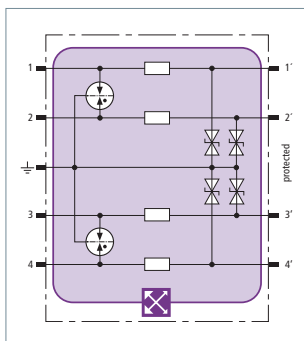

The basic circuit diagram graphically shows whether LifeCheck is used to monitor the protective circuit of an arrester. In case of BXT arresters, the complete protective circuit is monitored.

Yellow/Line Selection Guide



Bus systems and measuring and control equipment

Telecommunications, telephone systems

Data networks

Antenna systems, broadband systems, transmitting and receiving systems, video systems

Page 135 – 145























































Page 146 – 150

Page 151 – 152

Page 153 – 155

Antenna systems, broadband systems, transmitting and receiving systems, video systems. In practice, there may be other interface parameters. Therefore, we recommend to check whether the electrical parameters are suited for the interface to be protected before using the arrester.

Bus systems and measuring and control equipment

Interface / Signal<	For mounting on	Ex	Connection system	Protected lines	LifeCheck	SPD class TYPE	SPD	Part No.	Page
0-20 mA, 4-20 mA (also with HART)			Screw terminals	4	●	1		920 324 ¹⁾	160
			Screw terminals	2	●	1		920 224 ¹⁾	163
			Screw terminals	4		2		926 324 ¹⁾	167
			Screw terminals	2		2		926 224 ¹⁾	168
			Spring terminals	2		2		917 921	178
			Spring terminals	2		3		917 988	178
			Wires / Terminals	2		2		929 921	198
			LSA	20		1		907 401 + 907 422 + 907 498	189 191
4-20 mA (also with HART) acc. to NAMUR recommendation NE 21 or according to EN 61000-4-5, open-circuit voltage 1 kV line-PG			Screw terminals	4	●	1		920 344 ¹⁾	160
			Screw terminals	2	●	1		920 244 ¹⁾	162
			Screw terminals	4		2		926 344 ¹⁾	168
			Screw terminals	2		2		926 244 ¹⁾	169
			Spring terminals	2		2		917 941	178
			Wires / Terminals	2		2		929 941	198
			LSA	20		1		907 401 + 907 442 + 907 498	189 191
3/4 conductor measurement			Screw terminals	4	●	1		920 350 ¹⁾	161
			Screw terminals	4	●	1		920 354 ¹⁾	161
ADVANT			Screw terminals	4	●	1		920 370 ¹⁾	161
			Screw terminals	2	●	1		920 270 ¹⁾	163
			Screw terminals	4		2		926 370 ¹⁾	168
			Screw terminals	2		2		926 270 ¹⁾	169
			Screw terminals	5		2		918 401	183
			Spring terminals	2		2		917 970	178
AS interface			Screw terminals	4	●	1		920 345 ¹⁾	160
			Screw terminals	2	●	1		920 245 ¹⁾	162
			Screw terminals	4		2		926 345 ¹⁾	168
			Screw terminals	2		2		926 245 ¹⁾	169

¹⁾ with universal base part BXT BAS (Part No. 920 300) or BSP BAS 4 (Part No. 926 304) please refer to page 158

²⁾ with universal base part BXT BAS EX (Part No. 920 301) please refer to page 170

Bus systems and measuring and control equipment











































































Easy Choice

Interface / Signal	For mounting on	Ex	Connection system	Protected lines	LifeCheck	SPD class TYPE	SPD	Part No.	Page
BACnet/IP			RJ45	4 x 2		2		929 100	204
			RJ45	4 x 2		2		929 121	204
			RJ45	4 x 2		2		929 126	204
			RJ45	4 x 2		2		929 221	203
			RJ45, LSA	8 x 8		3		929 035 / 036	206
			RJ45	8 x 8		4		929 037	206
			RJ45	4		2		909 321	211
BACnet MS/TP			Screw terminals	4	●	1		920 371 ¹⁾	161
			Screw terminals	2	●	1		920 271 ¹⁾	163
			Screw terminals	4		2		926 371 ¹⁾	169
			Screw terminals	2		2		926 271 ¹⁾	169
			Spring terminals	2		2		917 970	178
			LSA	20		1		907 401 + 907 465 + 907 498	189 191
Binary signals			Screw terminals	4	●	1		920 320 – 327 ¹⁾	160
			Screw terminals	2	●	1		920 220 – 225 ¹⁾	163
			Screw terminals	4		2		926 320 – 327 ¹⁾	167
			Screw terminals	2		2		926 220 – 225 ¹⁾	168
			Spring terminals	2		2		917 920 – 922	178
			Spring terminals	2		3		917 987 – 989	178
			LSA	20		1		907 401 + 907 422 + 907 498	189 191
Bitbus			Screw terminals	4	●	1		920 370 ¹⁾	161
			Screw terminals	2	●	1		920 270 ¹⁾	163
			Screw terminals	4		2		926 370 ¹⁾	168
			Screw terminals	2		2		926 270 ¹⁾	169
			Spring terminals	2		2		917 970	178
BLN (Building Level Network)			Screw terminals	4	●	1		920 342 ¹⁾	160
			Screw terminals	2	●	1		920 242 ¹⁾	162
			Screw terminals	4	●	1		920 345 ¹⁾	160
			Screw terminals	2	●	1		920 245 ¹⁾	162
			Screw terminals	4		2		926 342 ¹⁾	168
			Screw terminals	2		2		926 242 ¹⁾	169
			Screw terminals	4		2		926 345 ¹⁾	168
			Screw terminals	2		2		926 245 ¹⁾	169
CAN-Bus (data line only)			Screw terminals	4	●	1		920 371 ¹⁾	161
			Screw terminals	2	●	1		920 271 ¹⁾	163
			Screw terminals	4		2		926 371 ¹⁾	169
			Screw terminals	2		2		926 271 ¹⁾	169
			Spring terminals	2		2		917 970	178
			LSA	20		1		907 401 + 907 465 + 907 498	189 191

¹⁾ with universal base part BXT BAS (Part No. 920 300) or BSP BAS 4 (Part No. 926 304) please refer to page 158

²⁾ with universal base part BXT BAS EX (Part No. 920 301) please refer to page 170

































































































Bus systems and measuring and control equipment

Interface / Signal	For mounting on	Ex	Connection system	Protected lines	LifeCheck	SPD class TYPE	SPD	Part No.	Page
C bus (Honeywell) 			Screw terminals	4	●	1		920 371 ¹⁾	161
			Screw terminals	2	●	1		920 271 ¹⁾	163
			Screw terminals	4		2		926 371 ¹⁾	169
			Screw terminals	2		2		926 271 ¹⁾	169
			Spring terminals	2		2		917 970	178
CCP systems Sensor circuit Anode circuit			Screw terminals	2		1		918 421	185
			Screw terminals	2		1		918 420	185
Control Net			BNC	1		2		929 010	218
			BNC	1		2		909 710 / 711	218
DALI Bus			Screw terminals	2	●	1		920 244 ¹⁾	162
			Screw terminals	2		2		926 244 ¹⁾	169
Data Highway Plus 			Screw terminals	4	●	1		920 342 ¹⁾	160
			Screw terminals	2	●	1		920 242 ¹⁾	162
			Screw terminals	4		2		926 342 ¹⁾	168
			Screw terminals	2		2		926 242 ¹⁾	169
			Spring terminals	2		2		917 940	178
d.c. power supply up to 60 V d.c.			Screw terminals	2		3		918 422	184
			Screw terminals	2		1		918 408	184
			Screw terminals	2		1		918 409	184
Delta Net Peer Bus			Screw terminals	4	●	1		920 370 ¹⁾	161
			Screw terminals	2	●	1		920 270 ¹⁾	163
			Screw terminals	4		2		926 370 ¹⁾	168
			Screw terminals	2		2		926 270 ¹⁾	169
			Spring terminals	2		2		917 970	178
Device Net (data line only) 			Screw terminals	4	●	1		920 371 ¹⁾	161
			Screw terminals	2	●	1		920 271 ¹⁾	163
			Screw terminals	4		2		926 371 ¹⁾	169
			Screw terminals	2		2		926 271 ¹⁾	169
			Spring terminals	2		2		917 970	178
DMX bus (lighting technology) 			Screw terminals	4	●	1		920 371 ¹⁾	161
			Screw terminals	2	●	1		920 271 ¹⁾	163
			Screw terminals	4		2		926 371 ¹⁾	169
			Screw terminals	2		2		926 271 ¹⁾	169
			Spring terminals	2		2		917 970	178
Dupline 			Screw terminals	4	●	1		920 243 ¹⁾	164

¹⁾ with universal base part BXT BAS (Part No. 920 300) or BSP BAS 4 (Part No. 926 304) please refer to page 158
²⁾ with universal base part BXT BAS EX (Part No. 920 301) please refer to page 170

Bus systems and measuring and control equipment



























































































Easy Choice

Interface / Signal	For mounting on	Ex	Connection system	Protected lines	LifeCheck	SPD class TYPE	SPD	Part No.	Page
E bus (Honeywell) 			Screw terminals	4		1		920 345 ¹⁾	160
			Screw terminals	2		1		920 245 ¹⁾	162
			Screw terminals	4		2		926 345 ¹⁾	168
			Screw terminals	2		2		926 245 ¹⁾	169
EIB			Screw terminals	4		1		920 310 ¹⁾	159
			Screw terminals	2		1		920 211 ¹⁾	163
			Wires	2		2		925 001	212
			LSA	20		1		907 401	189
Electroacoustic system			Screw terminals	4		1		920 347 ¹⁾	160
			Screw terminals	4		2		926 347 ¹⁾	168
			Spring terminals	2		1		928 430	182
			LSA	20		1		907 401 + 907 445 + 907 498	189 191
ET 200			Screw terminals	4		1		920 370 ¹⁾	161
			Screw terminals	2		1		920 270 ¹⁾	163
			Screw terminals	4		2		926 370 ¹⁾	168
			Screw terminals	2		2		926 270 ¹⁾	169
			Spring terminals	2		2		917 970	178
Ex(d) circuits 4-20 mA, NAMUR, HART, PROFIBUS-PA, F			Wires	2		2		929 962 / 964	199
			Wires	4		2		929 950 / 951	200
Ex (i) circuits			Screw terminals	4		2		920 381 ²⁾	171
			Screw terminals	4		2		920 538 ²⁾	171
			Screw terminals	2		2		920 280 ²⁾	171
			Screw terminals	2		2		920 383 ²⁾	172
			Spring terminals	2		2		917 960	179
			Wires / Terminals	2		2		929 960 / 965	199
			Wires	2		2		929 961 / 963	199
			Wires	4		2		929 950 / 951	200
			Screw terminals	4		2		989 408	172
Fieldbus Foundation 			Screw terminals	4		1		920 344 ¹⁾	160
			Screw terminals	2		1		920 244 ¹⁾	162
			Screw terminals	4		2		926 344 ¹⁾	168
			Screw terminals	2		2		926 244 ¹⁾	169
			Spring terminals	2		2		917 941	178
			Wires / Terminals	2		2		929 941	198
			LSA	20		1		907 401 + 907 442 + 907 498	189 191

¹⁾ with universal base part BXT BAS (Part No. 920 300) or BSP BAS 4 (Part No. 926 304) please refer to page 158

²⁾ with universal base part BXT BAS EX (Part No. 920 301) please refer to page 170













































































Bus systems and measuring and control equipment

Interface / Signal	For mounting on	Ex	Connection system	Protected lines	LifeCheck	SPD class TYPE	SPD	Part No.	Page
Fieldbus Foundation Ex (i)			Screw terminals	4		2		920 381 ²⁾	171
			Screw terminals	4		2		920 538 ²⁾	171
			Screw terminals	2		2		920 280 ²⁾	171
			Screw terminals	2		2		920 383 ²⁾	172
			Spring terminals	2		2		917 960	179
			Wires / Terminals	2		2		929 960 / 965	199
			Wires	2		2		929 961 / 963	199
			Wires	2		2		929 971	199
			Wires	4		2		929 950 / 951	200
			Screw terminals	4		2		989 408	172
FIPIO/FIPWAY			Screw terminals	4		1		920 344 ¹⁾	160
			Screw terminals	2		1		920 244 ¹⁾	162
			Screw terminals	4		2		926 344 ¹⁾	168
			Screw terminals	2		2		926 244 ¹⁾	169
FIP I/O			Screw terminals	4		1		920 370 ¹⁾	161
			Screw terminals	2		1		920 270 ¹⁾	163
			Screw terminals	4		2		926 370 ¹⁾	168
			Screw terminals	2		2		926 270 ¹⁾	169
FSK 			Screw terminals	4		1		920 371 ¹⁾	161
			Screw terminals	2		1		920 271 ¹⁾	163
			Screw terminals	4		2		926 371 ¹⁾	169
			Screw terminals	2		2		926 271 ¹⁾	169
			Spring terminals	2		2		917 970	178
Genius I/O Bus			Screw terminals	4		1		920 342 ¹⁾	160
			Screw terminals	2		1		920 242 ¹⁾	162
			Screw terminals	4		2		926 342 ¹⁾	168
			Screw terminals	2		2		926 242 ¹⁾	169
IEC bus (RS485) 			Screw terminals	4		1		920 371 ¹⁾	161
			Screw terminals	2		1		920 271 ¹⁾	163
			Screw terminals	4		2		926 371 ¹⁾	169
			Screw terminals	2		2		926 271 ¹⁾	169
			Spring terminals	2		2		917 970	178

¹⁾ with universal base part BXT BAS (Part No. 920 300) or BSP BAS 4 (Part No. 926 304) please refer to page 158
²⁾ with universal base part BXT BAS EX (Part No. 920 301) please refer to page 170

Bus systems and measuring and control equipment































































































Easy Choice

Interface / Signal	For mounting on	Ex	Connection system	Protected lines	LifeCheck 	SPD class TYPE	SPD 	Part No.	Page
Industrial Ethernet			LSA	20		1		907 401 + 907 470 + 907 498	189 191
			RJ45	4 x 2		2		929 100	204
			RJ45	4 x 2		2		929 121	204
			RJ45	4 x 2		2		929 126	204
			RJ45	4 x 2		2		929 221	203
			RJ45, LSA / RJ45	8 x 8		3		929 035 / 036	206
			RJ45	8 x 8		4		929 037	206
			RJ45	4		2		909 321	211
INTERBUS INLINE (I/O) 			Screw terminals	4	●	1		920 345 ¹⁾	160
			Screw terminals	4	●	1		920 325 ¹⁾	160
			Screw terminals	4		2		926 345 ¹⁾	168
			Screw terminals	4		2		926 325 ¹⁾	167
Interbus INLINE remote bus 			Screw terminals	4	●	1		920 371 ¹⁾	161
			Screw terminals	2	●	1		920 271 ¹⁾	163
			Screw terminals	4		2		926 371 ¹⁾	169
			Screw terminals	2		2		926 271 ¹⁾	169
			Screw terminals	5		2		918 401	183
INTERBUS-Loop			Spring terminals	2		3		917 988	178
K bus			Screw terminals	4	●	1		920 344 ¹⁾	160
			Screw terminals	2	●	1		920 244 ¹⁾	162
			Screw terminals	4		2		926 344 ¹⁾	168
			Screw terminals	2		2		926 244 ¹⁾	169
			Spring terminals	2		2		917 941	178
KBR energy bus			Screw terminals	4	●	1		920 370 ¹⁾	161
			Screw terminals	2	●	1		920 270 ¹⁾	163
			Screw terminals	4		2		926 370 ¹⁾	168
			Screw terminals	2		2		926 270 ¹⁾	169
			Spring terminals	2		2		917 970	178
KNX bus			Screw terminals	4	●	1		920 310 ¹⁾	159
			Screw terminals	2	●	1		920 211 ¹⁾	163
			Wires	2		2		925 001	212
			LSA	20		1		907 401	189
LON – TP/XF 78 ... part 1/2 ...			Screw terminals	4	●	1		920 340 ¹⁾	160
			Screw terminals	2	●	1		920 240 ¹⁾	162
			Screw terminals	4		2		926 340 ¹⁾	168
			Screw terminals	2		2		926 240 ¹⁾	169

¹⁾ with universal base part BXT BAS (Part No. 920 300) or BSP BAS 4 (Part No. 926 304) please refer to page 158

²⁾ with universal base part BXT BAS EX (Part No. 920 301) please refer to page 170























































































Bus systems and measuring and control equipment

Interface / Signal	For mounting on	Ex	Connection system	Protected lines	LifeCheck	SPD class TYPE	SPD	Part No.	Page
... part 2/2 ...									
LON – TP/FTT10 (up to 1 A) and TP/LPT10 (up to 1 A) (up to 1,7 A) (up to 0,4 A) – TP/FTT 10			Screw terminals	4		1		920 345 ¹⁾	160
			Screw terminals	2		1		920 245 ¹⁾	162
			Screw terminals	4		2		926 345 ¹⁾	168
			Screw terminals	2		2		926 245 ¹⁾	169
			Spring terminals	2		2		917 942	178
			LSA	20		1		907 401 + 907 443 + 907 498	189 191
			Screw terminals	4		1		920 371 ¹⁾	161
			Screw terminals	2		1		920 271 ¹⁾	163
LUXMATE bus									
			Screw terminals	4		1		920 344 ¹⁾	160
			Screw terminals	2		1		920 244 ¹⁾	162
			Screw terminals	4		2		926 344 ¹⁾	168
			Screw terminals	2		2		926 244 ¹⁾	169
M bus									
			Screw terminals	4		1		920 345 ¹⁾	160
			Screw terminals	2		1		920 245 ¹⁾	162
			Screw terminals	4		2		926 345 ¹⁾	168
			Screw terminals	2		2		926 245 ¹⁾	169
			Spring terminals	2		2		917 942	178
			LSA	20		1		907 401 + 907 443 + 907 498	189 191
Melsec Net 2									
			BNC	1		2		929 010	218
			BNC	1		2		909 710 / 711	218
MODBUS									
			Screw terminals	4		1		920 371 ¹⁾	161
			Screw terminals	2		1		920 271 ¹⁾	163
			Screw terminals	4		2		926 371 ¹⁾	169
			Screw terminals	2		2		926 271 ¹⁾	169
			Spring terminals	2		2		917 970	178
			LSA	20		1		907 401 + 907 465 + 907 498	189 191
MPI bus									
			Screw terminals	4		1		920 371 ¹⁾	161
			Screw terminals	2		1		920 271 ¹⁾	163
			Screw terminals	4		2		926 371 ¹⁾	169
			Screw terminals	2		2		926 271 ¹⁾	169
			Spring terminals	2		2		917 970	178
N1 LAN									
... part 1/2 ...			Screw terminals	4		1		920 371 ¹⁾	161
			Screw terminals	2		1		920 271 ¹⁾	163
			Screw terminals	4		1		920 370 ¹⁾	161
			Screw terminals	2		1		920 270 ¹⁾	163
			Screw terminals	4		2		926 371 ¹⁾	169
			Screw terminals	2		2		926 271 ¹⁾	169

¹⁾ with universal base part BXT BAS (Part No. 920 300) or BSP BAS 4 (Part No. 926 304) please refer to page 158
²⁾ with universal base part BXT BAS EX (Part No. 920 301) please refer to page 170

Bus systems and measuring and control equipment





















































































Easy Choice

Interface / Signal	For mounting on	Ex	Connection system	Protected lines	LifeCheck 	SPD class TYPE	SPD 	Part No.	Page
... part 2/2 ... N1 LAN			Screw terminals	4		2		926 370 ¹⁾	168
			Screw terminals	2		2		926 270 ¹⁾	169
			Spring terminals	2		2		917 970	178
			BNC	1		2		909 710 / 711	218
N2 Bus (Johnson Controls, LON, FTT 10)			Screw terminals	4	●	1		920 371 ¹⁾	161
			Screw terminals	2	●	1		920 271 ¹⁾	163
			Screw terminals	4		2		926 371 ¹⁾	169
			Screw terminals	2		2		926 271 ¹⁾	169
Optocoupler interface			Screw terminals	4	●	1		920 364 ¹⁾	161
Procontic CS31 (RS232)			Screw terminals	4	●	1		920 322 ¹⁾	160
			Screw terminals	4		2		926 322 ¹⁾	167
Procontic T200 (RS422) 			Screw terminals	4	●	1		920 371 ¹⁾	161
			Screw terminals	4		2		926 371 ¹⁾	169
			Screw terminals	5		2		918 401	183
PROFIBUS-DP/FMS			Screw terminals	4	●	1		920 371 ¹⁾	161
			Screw terminals	2	●	1		920 271 ¹⁾	163
			Screw terminals	4		2		926 371 ¹⁾	169
			Screw terminals	2		2		926 271 ¹⁾	169
			9-pin SUB-D	4		4		924 017	223
			Spring terminals	2		2		917 970	178
			LSA	20		1		907 401 + 907 465 + 907 498	189 191
PROFIBUS-PA 			Screw terminals	4	●	1		920 344 ¹⁾	160
			Screw terminals	2	●	1		920 244 ¹⁾	162
			Screw terminals	4		2		926 344 ¹⁾	168
			Screw terminals	2		2		926 244 ¹⁾	169
			Spring terminals	2		2		917 941	178
			Wires / Terminals	2		2		929 941	198
			LSA	20		1		907 401 + 907 442 + 907 498	189 191
	PROFIBUS-PA Ex (i)			Screw terminals	4	●	2		920 381 ²⁾
			Screw terminals	2	●	2		920 538 ²⁾	171
			Screw terminals	2	●	2		920 280 ²⁾	171
			Screw terminals	2		2		920 383 ²⁾	172
			Spring terminals	2		2		917 960	179
			Wires / Terminals	2		2		929 960 / 965	199
			Wires	2		2		929 961 / 963	199
			Wires	4		2		929 950 / 951	200
			Screw terminals	4	●	2		989 408	172

¹⁾ with universal base part BXT BAS (Part No. 920 300) or BSP BAS 4 (Part No. 926 304) please refer to page 158

²⁾ with universal base part BXT BAS EX (Part No. 920 301) please refer to page 170







































































Bus systems and measuring and control equipment

Interface / Signal	For mounting on	Ex	Connection system	Protected lines	LifeCheck	SPD class TYPE	SPD	Part No.	Page
 PROFIBUS SIMATIC NET			Screw terminals	4	●	1		920 371 ¹⁾	161
			Screw terminals	2	●	1		920 271 ¹⁾	163
			Screw terminals	4		2		926 371 ¹⁾	169
			Screw terminals	2		2		926 271 ¹⁾	169
 PSM-EG-RS422			Screw terminals	4	●	1		920 371 ¹⁾	161
			Screw terminals	4		2		926 371 ¹⁾	169
			Screw terminals	5		2		918 401	183
 PSM-EG-RS485			Screw terminals	4	●	1		920 371 ¹⁾	161
			Screw terminals	2	●	1		920 271 ¹⁾	163
			Screw terminals	4		2		926 371 ¹⁾	169
			Screw terminals	2		2		926 271 ¹⁾	169
			Screw terminals	5		2		918 401	183
 Rackbus (RS485)			Screw terminals	4	●	1		920 371 ¹⁾	161
			Screw terminals	2	●	1		920 271 ¹⁾	163
			Screw terminals	4		2		926 371 ¹⁾	169
			Screw terminals	2		2		926 271 ¹⁾	169
			Screw terminals	5		2		918 401	183
 R bus			Screw terminals	4	●	1		920 340 ¹⁾	160
			Screw terminals	2	●	1		920 240 ¹⁾	162
			Screw terminals	4		2		926 340 ¹⁾	168
			Screw terminals	2		2		926 240 ¹⁾	169
			Spring terminals	2		2		917 970	178
 RS 485			Screw terminals	4	●	1		920 371 ¹⁾	161
			Screw terminals	4		2		926 371 ¹⁾	169
			Screw terminals	4	●	2		920 538 ²⁾	171
			Screw terminals	2	●	1		920 271 ¹⁾	163
			Screw terminals	2		2		926 271 ¹⁾	169
			Screw terminals	5		2		918 401	183
			Spring terminals	2		2		917 970	178
			Wires	2		2		929 971	199
			LSA	20		1		907 401 + 907 465 + 907 498	189 191
 RS422, V11			Screw terminals	4	●	1		920 371 ¹⁾	161
			Screw terminals	2	●	1		920 271 ¹⁾	163
			Screw terminals	4		2		926 371 ¹⁾	169
			Screw terminals	2		2		926 271 ¹⁾	169
			Screw terminals	5		2		918 401	183
			Spring terminals	2		2		917 970	178
			LSA	20		1		907 401 + 907 465 + 907 498	189 191

¹⁾ with universal base part BXT BAS (Part No. 920 300) or BSP BAS 4 (Part No. 926 304) please refer to page 158
²⁾ with universal base part BXT BAS EX (Part No. 920 301) please refer to page 170

Bus systems and measuring and control equipment









































































Easy Choice

Interface / Signal	For mounting on	Ex	Connection system	Protected lines	LifeCheck 	SPD class TYPE	SPD 	Part No.	Page
S bus			Screw terminals	4	●	1		920 370 ¹⁾	161
			Screw terminals	2	●	1		920 270 ¹⁾	163
			Screw terminals	4		2		926 370 ¹⁾	168
			Screw terminals	2		2		926 270 ¹⁾	169
			Spring terminals	2		2		917 970	178
SafetyBUS p 			Screw terminals	4	●	1		920 371 ¹⁾	161
			Screw terminals	2	●	1		920 271 ¹⁾	163
			Screw terminals	4		2		926 371 ¹⁾	169
			Screw terminals	2		2		926 271 ¹⁾	169
			Spring terminals	2		2		917 970	178
SDLC			Screw terminals	4	●	1		920 370 ¹⁾	161
			Screw terminals	2	●	1		920 270 ¹⁾	163
			Screw terminals	4		2		926 370 ¹⁾	168
			Screw terminals	2		2		926 270 ¹⁾	169
			Spring terminals	2		2		917 970	178
SDLS			LSA	20	●	1		907 401 + 907 423 + 907 498	189 191
Securilan-LON-Bus (LONWORKS technology Standard bus based on Echelon)			Screw terminals	4	●	1		920 340 ¹⁾	160
			Screw terminals	2	●	1		920 240 ¹⁾	162
			Screw terminals	4		2		926 340 ¹⁾	168
			Screw terminals	2		2		926 240 ¹⁾	169
			Spring terminals	2		2		917 970	178
SIGMASYS (Siemens fire alarm system)			Screw terminals	4	●	1		920 345 ¹⁾	160
			Screw terminals	2	●	1		920 245 ¹⁾	162
			Screw terminals	4	●	1		920 325 ¹⁾	160
			Screw terminals	2	●	1		920 225 ¹⁾	163
			Screw terminals	4		2		926 345 ¹⁾	168
			Screw terminals	2		2		926 245 ¹⁾	169
			Screw terminals	4		2		926 325 ¹⁾	167
			Screw terminals	2		2		926 225 ¹⁾	168
			LSA	20		1		907 401 + 907 423 + 907 498	189 191
SINEC L1			Screw terminals	4	●	1		920 370 ¹⁾	161
			Screw terminals	2	●	1		920 270 ¹⁾	163
			Screw terminals	4		2		926 370 ¹⁾	168
			Screw terminals	2		2		926 270 ¹⁾	169

¹⁾ with universal base part BXT BAS (Part No. 920 300) or BSP BAS 4 (Part No. 926 304) please refer to page 158

²⁾ with universal base part BXT BAS EX (Part No. 920 301) please refer to page 170

Bus systems and measuring and control equipment





































































Interface / Signal	For mounting on	Ex	Connection system	Protected lines	LifeCheck 	SPD class TYPE	SPD	Part No.	Page
SINEC L2			Screw terminals	4	●	1		920 370 ¹⁾	161
			Screw terminals	2	●	1		920 270 ¹⁾	163
			Screw terminals	4		2		926 370 ¹⁾	168
			Screw terminals	2		2		926 270 ¹⁾	169
			Spring terminals	2		2		917 970	178
			9-pin SUB-D	4		4		924 017	223
SS97 SIN/X (RS 232)			Screw terminals	4	●	1		920 322 ¹⁾	160
			Screw terminals	2	●	1		920 222 ¹⁾	163
			Screw terminals	4		2		926 322 ¹⁾	167
			Screw terminals	2		2		926 222 ¹⁾	168
SUCONET 			Screw terminals	4	●	1		920 371 ¹⁾	161
			Screw terminals	2	●	1		920 271 ¹⁾	163
			Screw terminals	4		2		926 371 ¹⁾	169
			Screw terminals	2		2		926 271 ¹⁾	169
Temperature measurement PT 100, PT 1000, Ni 1000, NTC, PTC			Screw terminals	4	●	1		920 354 ¹⁾	161
			Screw terminals	4	●	1		920 322 ¹⁾	160
			Screw terminals	2	●	1		920 222 ¹⁾	163
			Screw terminals	4		2		926 322 ¹⁾	167
			Screw terminals	2		2		926 222 ¹⁾	168
			Spring terminals	2		2		917 920	178
Temperature measurement Ex (i) PT 100, PT 1000 Ni 1000, NTC, PTC			Screw terminals	4	●	2		920 384 ²⁾	171
TTL			Screw terminals	4	●	1		920 322 ¹⁾	160
			Screw terminals	2	●	1		920 222 ¹⁾	163
			Screw terminals	4		2		926 322 ¹⁾	167
			Screw terminals	2		2		926 222 ¹⁾	168
			Spring terminals	2		2		917 920	178
TTY			Screw terminals	4	●	1		920 364 ¹⁾	161
			Screw terminals	4	●	1		920 362 ¹⁾	161
TTY 4 – 20 mA			Screw terminals	4	●	1		920 324 ¹⁾	160
			Screw terminals	2	●	1		920 224 ¹⁾	163
			Screw terminals	4		2		926 324 ¹⁾	167
			Screw terminals	2		2		926 224 ¹⁾	168
			Spring terminals	2		2		917 921	178
			Spring terminals	2		3		917 988	178
			Wires / Terminals	2		2		929 921	198

¹⁾ with universal base part BXT BAS (Part No. 920 300) or BSP BAS 4 (Part No. 926 304) please refer to page 158

²⁾ with universal base part BXT BAS EX (Part No. 920 301) please refer to page 170

































































Telecommunications, telephone systems

Easy Choice

Interface / Signal	For mounting on	Connection system	Protected lines	LifeCheck	SPD class TYPE	SPD	Part No.	Page
		LSA	20		1		907 401 + 907 430 + 907 498	189 191
		RJ45, LSA / RJ45	8 x 2		2		929 071 / 072	206
		Screw terminals	4	●	1		920 347 ¹⁾	160
		Screw terminals	4		2		926 347 ¹⁾	168
		RJ45, Screw terminals	2		2		918 411	184
		TAE, RJ12	2		2		909 310	211
		Spring terminals / RJ45	2		2		929 230	207
		Spring terminals	2		1		922 210	214
		Screw terminals	4	●	1		920 347 ¹⁾	160
		Screw terminals	2	●	1		920 247 ¹⁾	162
		Screw terminals	4		2		926 347 ¹⁾	168
		Screw terminals	2		2		926 247 ¹⁾	169
		LSA	20		1		907 401 + 907 430 + 907 498	189 191
		TAE, RJ12	2		2		909 310	211
		RJ45, LSA / RJ45	8 x 2		2		929 071 / 072	206
		RJ45, Screw terminals	2		2		918 411	184
		Spring terminals / RJ45	2		2		929 230	207
		Spring terminals	2		1		922 210	214
		LSA	20		1		907 401 + 907 430 + 907 498	189 191
		Screw terminals	4	●	1		920 347 ¹⁾	160
		Screw terminals	4		2		926 347 ¹⁾	168
		Spring terminals	2		1		922 210	214
Datex-P		Screw terminals	4	●	1		920 375 ¹⁾	161
		Screw terminals	4		2		926 375 ¹⁾	169
E1		RJ45	4 x 2		2		929 100	204
		RJ45	4 x 2		2		929 121	204
		RJ45	4 x 2		2		929 126	204
		RJ45	4 x 2		2		929 221	203
		LSA	20		1		907 401 + 907 470 + 907 498	189 191
		LSA / RJ45	8 x 4		2		929 075	207
		Screw terminals	4	●	1		920 375 ¹⁾	161
		Screw terminals	4		2		926 375 ¹⁾	169
G.703 coax		1.6/5.6 connector	1		3		929 040	220

¹⁾ with universal base part BXT BAS (Part No. 920 300) or BSP BAS 4 (Part No. 926 304) please refer to page 158
²⁾ with universal base part BXT BAS EX (Part No. 920 301) please refer to page 170

Telecommunications, telephone systems

































































Interface / Signal	For mounting on	Connection system	Protected lines	LifeCheck	SPD class TYPE	SPD	Part No.	Page
G.703 / G.704		IPC terminals	2		2		907 214	192
		LSA / RJ45	8 x 4		2		929 075	207
		RJ45	4 x 2		2		929 100	204
		RJ45	4 x 2		2		929 121	204
		RJ45	4 x 2		2		929 126	204
		RJ45	4 x 2		2		929 221	203
		LSA	20		1		907 401 + 907 470 + 907 498	189 191
		Screw terminals	4	●	1		920 375 ¹⁾	161
		Screw terminals	4		2		926 375 ¹⁾	169
HDSL		Screw terminals	4	●	1		920 375 ¹⁾	161
		Screw terminals	4		2		926 375 ¹⁾	169
		LSA	20		1		907 401 + 907 470 + 907 498	189 191
		RJ45	4 x 2		2		929 100	204
		RJ45	4 x 2		2		929 121	204
		RJ45	4 x 2		2		929 126	204
		RJ45	4 x 2		2		929 221	203
		LSA / RJ45	8 x 4		2		929 075	207
	IP telephone		RJ45	4 x 2		2		929 100
		RJ45	4 x 2		2		929 121	204
		RJ45	4 x 2		2		929 126	204
		RJ45	4 x 2		2		929 221	203
		RJ45	8 x 8		4		929 037	206
		RJ45	4		2		909 321	211
		Spring terminals	2		1		922 210	214
ISDN S ₀			Screw terminals	4	●	1		920 375 ¹⁾
		Screw terminals	4		2		926 375 ¹⁾	169
		LSA	20		1		907 401 + 907 470 + 907 498	189 191
		RJ45	4		2		909 320	211
		RJ45	4 x 2		2		929 100	204
		RJ45	4 x 2		2		929 121	204
		RJ45	4 x 2		2		929 126	204
		RJ45	4 x 2		2		929 221	203



¹⁾ with universal base part BXT BAS (Part No. 920 300) or BSP BAS 4 (Part No. 926 304) please refer to page 158
²⁾ with universal base part BXT BAS EX (Part No. 920 301) please refer to page 170





















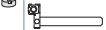























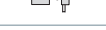













Telecommunications, telephone systems

Easy Choice

Interface / Signal	For mounting on	Connection system	Protected lines	LifeCheck 	SPD class TYPE	SPD 	Part No.	Page
 ISDN S _{2m} / U _{2m}		Screw terminals	4	●	1		920 375 ¹⁾	161
		Screw terminals	4		2		926 375 ¹⁾	169
		LSA	20		1		907 401 + 907 470 + 907 498	189 191
		RJ45	4 x 2		2		929 100	204
		RJ45	4 x 2		2		929 121	204
		RJ45	4 x 2		2		929 126	204
		RJ45	4 x 2		2		929 221	203
		LSA / RJ45	8 x 4		2		929 075	207
 ISDN U _{K0} / U _{P0}		Screw terminals	4	●	1		920 347 ¹⁾	160
		Screw terminals	2	●	1		920 247 ¹⁾	162
		Screw terminals	4		2		926 347 ¹⁾	168
		Screw terminals	2		2		926 247 ¹⁾	169
		LSA	20		1		907 401 + 907 430 + 907 498	189 191
		RJ45, LSA / RJ45	8 x 2		2		929 071 / 072	206
		TAE, RJ12	2		2		909 310	211
		RJ45, Screw terminals	2		2		918 411	184
		Spring terminals / RJ45	10 x 2		2		929 230	207
		Spring terminals	2		1		922 210	214
 Modem M1		Screw terminals	4	●	1		920 322 ¹⁾	160
		Screw terminals	2	●	1		920 222 ¹⁾	163
		Screw terminals	4		2		926 322 ¹⁾	167
		Screw terminals	2		2		926 222 ¹⁾	168
 SDSL		RJ45	4 x 2		2		929 100	204
		RJ45	4 x 2		2		929 121	204
		RJ45	4 x 2		2		929 126	204
		RJ45	4 x 2		2		929 221	203
		LSA	20		1		907 401 + 907 470 + 907 498	189 191
		Screw terminals	4	●	1		920 375 ¹⁾	161
		Screw terminals	4		2		926 375 ¹⁾	169
		LSA / RJ45	8 x 4		2		929 075	207

¹⁾ with universal base part BXT BAS (Part No. 920 300) or BSP BAS 4 (Part No. 926 304) please refer to page 158
²⁾ with universal base part BXT BAS EX (Part No. 920 301) please refer to page 170

Telecommunications, telephone systems











































Interface / Signal	For mounting on	Connection system	Protected lines	LifeCheck	SPD class TYPE	SPD	Part No.	Page
SHDSL 		Screw terminals	4	●	1		920 375 ¹⁾	161
		Screw terminals	4		2		926 375 ¹⁾	169
		RJ45	4 x 2		2		929 100	204
		RJ45	4 x 2		2		929 121	204
		RJ45	4 x 2		2		929 126	204
		RJ45	4 x 2		2		929 221	203
		LSA	20		1		907 401 + 907 470 + 907 498	189 191
		Screw terminals	4	●	1		920 310 ¹⁾	159
		Screw terminals	2	●	1		920 211 ¹⁾	163
		LSA / RJ45	8 x 4		2		929 075	207
Telephones System telephones e.g. Siemens, HICOM, Alcatel 		Screw terminals	2	●	1		920 247 ¹⁾	162
		Screw terminals	2		2		926 247 ¹⁾	169
		LSA	20		1		907 401 + 907 422 + 907 498	189 191
		LSA	20		1		907 401 + 907 445 + 907 498	189 191
		RJ45, LSA / RJ45	8 x 2		2		929 071 / 072	206
		TAE, RJ12	2		2		909 310	211
		RJ45, Screw terminals	2		2		918 411	184
		Spring terminals / RJ45	10 x 2		2		929 230	207
		Spring terminals	2		1		922 210	214
T-DSL 		Screw terminals	4	●	1		920 347 ¹⁾	160
		Screw terminals	2	●	1		920 247 ¹⁾	162
		Screw terminals	4		2		926 347 ¹⁾	168
		Screw terminals	2		2		926 247 ¹⁾	169
		LSA	20		1		907 401 + 907 430 + 907 498	189 191
		TAE, RJ12	2		2		909 310	211
		RJ45, LSA / RJ45	8 x 2		2		929 071 / 072	206
		RJ45, Screw terminals	2		2		918 411	184
		Spring terminals / RJ45	10 x 2		2		929 230	207
		Spring terminals	2		1		922 210	214

¹⁾ with universal base part BXT BAS (Part No. 920 300) or BSP BAS 4 (Part No. 926 304) please refer to page 158

²⁾ with universal base part BXT BAS EX (Part No. 920 301) please refer to page 170

Telecommunications, telephone systems











































































Easy Choice

Interface / Signal	For mounting on	Connection system	Protected lines	LifeCheck 	SPD class TYPE	SPD 	Part No.	Page
Telecommunication systems 		LSA	20		1		907 401 + 907 430 + 907 498	189 191
		RJ45, LSA / RJ45	8 x 2		2		929 071 / 072	206
		Screw terminals	4	●	1		920 347 ¹⁾	160
		Screw terminals	4		2		926 347 ¹⁾	168
		RJ45, Screw terminals	2		2		918 411	184
		TAE, RJ12	2		2		909 310	211
		Spring terminals / RJ45	10 x 2		2		929 230	207
Universal lightning equipotential bonding		Screw terminals	4	●	1		920 310 ¹⁾	159
		Screw terminals	2	●	1		920 211 ¹⁾	163
		LSA	20		1		907 400	189
		LSA	20		1		907 401	189
		Schneidklemmen	20		2		907 214	192
		Schneidklemmen	20		2		907 216	192
VDSL 		LSA	20		1		907 401	189
		Screw terminals	4	●	1		920 310 ¹⁾	159
		Screw terminals	2	●	1		920 211 ¹⁾	163
		Spring terminals	2		1		922 210	214
VDSL2		Screw terminals	4	●	1		920 310 ¹⁾	159
		Spring terminals	2		1		922 210	214

¹⁾ with universal base part BXT BAS (Part No. 920 300) or BSP BAS 4 (Part No. 926 304) please refer to page 158























































²⁾ with universal base part BXT BAS EX (Part No. 920 301) please refer to page 170

Data networks

Interface / Signal	For mounting on	Connection system	Protected lines	LifeCheck	SPD class TYPE	SPD	Part No.	Page
Arcnet		BNC	1		2		929 010	218
		BNC	1		2		909 710 / 711	218
ATM		RJ45	4 x 2		2		929 100	204
		RJ45	4 x 2		2		929 121	204
		RJ45	4 x 2		2		929 126	204
		RJ45	4 x 2		2		929 221	203
		RJ45, LSA / RJ45	8 x 8		3		929 035 / 036	206
		RJ45	8 x 8		4		929 037	206
		RJ45	4		2		909 321	211
Ethernet 10/100/1000 10 Base T		RJ45	4 x 2		2		929 100	204
		RJ45	4 x 2		2		929 121	204
		RJ45	4 x 2		2		929 126	204
		RJ45	4 x 2		2		929 221	203
		RJ45, LSA / RJ45	8 x 8		3		929 035 / 036	206
		RJ45	8 x 8		4		929 037	206
		RJ45	4		2		909 321	211
		RJ45	4		2		909 320	211
		LSA	20		1		907 401 + 907 470 + 907 498	189 191
FDDI, CDDI		RJ45	4 x 2		2		929 100	204
		RJ45	4 x 2		2		929 121	204
		RJ45	4 x 2		2		929 126	204
		RJ45	4 x 2		2		929 221	203
		RJ45, LSA / RJ45	8 x 8		3		929 035 / 036	206
		RJ45	8 x 8		4		929 037	206
		RJ45	4		2		909 321	211
Industrial Ethernet		LSA	20		1		907 401 + 907 470 + 907 498	189 191
		RJ45	4 x 2		2		929 100	204
		RJ45	4 x 2		2		929 121	204
		RJ45	4 x 2		2		929 126	204
		RJ45	4 x 2		2		929 221	203
		RJ45, LSA / RJ45	8 x 8		3		929 035 / 036	206
		RJ45	8 x 8		4		929 037	206
		RJ45	4		2		909 321	211
Power over Ethernet PoE		RJ45	4 x 2		2		929 100	204
		RJ45	4 x 2		2		929 121	204
		RJ45	4 x 2		2		929 126	204
		RJ45	4 x 2		2		929 221	203

¹⁾ with universal base part BXT BAS (Part No. 920 300) or BSP BAS 4 (Part No. 926 304) please refer to page 158
²⁾ with universal base part BXT BAS EX (Part No. 920 301) please refer to page 170











































































Data networks

Interface / Signal	For mounting on	Connection system	Protected lines	LifeCheck 	SPD class TYPE	SPD	Part No.	Page
Token Ring		LSA	20		1		907 401 +907 470 +907 498	189 191
		RJ45	4 x 2		2		929 100	204
		RJ45	4 x 2		2		929 121	204
		RJ45	4 x 2		2		929 126	204
		RJ45	4 x 2		2		929 221	203
		RJ45, LSA / RJ45	8 x 8		3		929 035 / 036	206
		RJ45	8 x 8		4		929 037	206
		RJ45	4		2		909 321	211
V 24 (RS232 C)		Screw terminals	4		1		920 322 ¹⁾	160
		Screw terminals	4		2		926 322 ¹⁾	167
		Spring terminals	2		2		917 921	178
		LSA	20		1		907 401 +907 421 +907 498	189 191
VG-AnyLAN		RJ45	4 x 2		2		929 100	204
		RJ45	4 x 2		2		929 121	204
		RJ45	4 x 2		2		929 126	204
		RJ45	4 x 2		2		929 221	203
		RJ45, LSA / RJ45	8 x 8		3		929 035 / 036	206
		RJ45	8 x 8		4		929 037	206
		RJ45	4		2		909 321	211
Voice over IP		Screw terminals	4	●	1		920 310 ¹⁾	159
		RJ45	4 x 2		2		929 100	204
		RJ45	4 x 2		2		929 121	204
		RJ45	4 x 2		2		929 126	204
		RJ45	4 x 2		2		929 221	203
		RJ45	8 x 8		4		929 037	206
		RJ45	4		2		909 321	211
		Spring terminals	2		1		922 210	214

¹⁾ with universal base part BXT BAS (Part No. 920 300) or BSP BAS 4 (Part No. 926 304) please refer to page 158

²⁾ with universal base part BXT BAS EX (Part No. 920 301) please refer to page 170

Antenna systems, broadband systems, transmitting and receiving systems, video systems













































































Interface / Signal	For mounting on	Connection system	Protected lines	Frequency ran	SPD class TYPE	SPD	Part No.	Page
AMPS, NADAC (824 – 894 MHz)		SMA	1	d.c. – 5.8 GHz	2		929 039	220
		BNC	1	d.c. – 4 GHz	2		929 042	220
		BNC	1	d.c. – 1 GHz	1		929 043	220
		N connector	1	d.c. – 5.8 GHz	2		929 044	220
		N connector	1	d.c. – 2.5 GHz	1		929 045	220
		7/16 connector	1	d.c., 690 MHz – 2.7 GHz	1		929 146	221
		7/16 connector	1	690 MHz – 2.7 GHz	1		929 148	221
BWA (Broadband Wireless Access)		SMA	1	d.c. – 5.8 GHz	2		929 039	220
		BNC	1	d.c. – 4 GHz	2		929 042	220
		N connector	1	d.c. – 5.8 GHz	2		929 044	220
CATV (cable TV)		F connector	1	d.c., 5 – 2400 MHz	1		909 705	219
		IEC/F connector	1	d.c. – 2400 MHz	2		909 300	210
DCF 77		SMA	1	d.c. – 5.8 GHz	2		929 039	220
		BNC	1	d.c. – 4 GHz	2		929 042	220
		BNC	1	d.c. – 1 GHz	1		929 043	220
		Screw terminals	2	d.c. – 2.8 MHz	1		920 242 ¹⁾	162
		Screw terminals	2	d.c. – 2.8 MHz	2		926 242 ¹⁾	169
DCS 1800 B162 (1710 – 1880 MHz)		SMA	1	d.c. – 5.8 GHz	2		929 039	220
		BNC	1	d.c. – 4 GHz	2		929 042	220
		N connector	1	d.c. – 5.8 GHz	2		929 044	220
		N connector	1	d.c. – 2.5 GHz	1		929 045	220
		7/16 connector	1	d.c., 690 MHz – 2.7 GHz	1		929 146	221
		7/16 connector	1	690 MHz – 2.7 GHz	1		929 148	221
Radio systems		SMA	1	d.c. – 5.8 GHz	2		929 039	220
		BNC	1	d.c. – 4 GHz	2		929 042	220
		BNC	1	d.c. – 1 GHz	1		929 043	220
		N connector	1	d.c. – 5.8 GHz	2		929 044	220
		N connector	1	d.c. – 2.5 GHz	1		929 045	220
		7/16 connector	1	d.c., 690 MHz – 2.7 GHz	1		929 146	221
		7/16 connector	1	380 – 512 MHz	1		929 047	221
		7/16 connector	1	690 MHz – 2,7 GHz	1		929 148	221
GPS (1565 – 1585 MHz)		SMA	1	d.c. – 5.8 GHz	2		929 039	220
		BNC	1	d.c. – 4 GHz	2		929 042	220
		N connector	1	d.c. – 5.8 GHz	2		929 044	220
		N connector	1	d.c. – 2.5 GHz	1		929 045	220
		7/16 connector	1	d.c., 690 MHz – 2.7 GHz	1		929 146	221
		7/16 connector	1	690 MHz – 2.7 GHz	1		929 148	221

¹⁾ with universal base part BXT BAS (Part No. 920 300) or BSP BAS 4 (Part No. 926 304) please refer to page 158

²⁾ with universal base part BXT BAS EX (Part No. 920 301) please refer to page 170

Antenna systems, broadband systems, transmitting and receiving systems, video systems





















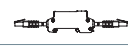











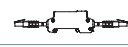













Easy Choice

Interface / Signal	For mounting on	Connection system	Protected lines	Frequency range	SPD class TYPE	SPD	Part No.	Page
GSM 900, GSMR (876 – 960 MHz)		SMA	1	d.c. – 5.8 GHz	2		929 039	220
		BNC	1	d.c. – 4 GHz	2		929 042	220
		BNC	1	d.c. – 1 GHz	1		929 043	220
		N connector	1	d.c. – 5.8 GHz	2		929 044	220
		N connector	1	d.c. – 2.5 GHz	1		929 045	220
		7/16 connector	1	d.c., 690 MHz – 2.7 GHz	1		929 146	221
		7/16 connector	1	690 MHz – 2.7 GHz	1		929 148	221
LTE (698 – 2690 MHz)		7/16 connector	1	d.c., 690 MHz – 2.7 GHz	1		929 146	221
		7/16 connector	1	690 MHz – 2.7 GHz	1		929 148	221
PCS 1900 (1850 – 1990 MHz)		SMA	1	d.c. – 5.8 GHz	2		929 039	220
		BNC	1	d.c. – 4 GHz	2		929 042	220
		N connector	1	d.c. – 5.8 GHz	2		929 044	220
		N connector	1	d.c. – 2.5 GHz	1		929 045	220
		7/16 connector	1	d.c., 690 MHz – 2.7 GHz	1		929 146	221
		7/16 connector	1	690 MHz – 2.7 GHz	1		929 148	221
SAT		F connector	1	d.c., 5 – 2400 MHz	1		909 705	219
		F connector	1	d.c., 5 – 3000 MHz	3		909 703	219
		F connector	1	d.c. – 2400 MHz	1		909 704	219
		F connector	1	47 – 2400 MHz	1		909 706	220
Sky DSL		F connector	1	d.c., 5 – 2400 MHz	1		909 705	219
		F connector	1	47 – 2400 MHz	1		909 706	220
TETRA, NMT 450 (380 – 512 MHz)		SMA	1	d.c. – 5.8 GHz	2		929 039	220
		BNC	1	d.c. – 4 GHz	2		929 042	220
		BNC	1	d.c. – 1 GHz	1		929 043	220
		N connector	1	d.c. – 5.8 GHz	2		929 044	220
		N connector	1	d.c. – 2.5 GHz	1		929 045	220
		7/16 connector	1	380 – 512 MHz	1		929 047	221
TV		F connector	1	d.c., 5 – 3000 MHz	3		909 703	219
		F connector	1	d.c. – 2400 MHz	1		909 704	219
		F connector	1	d.c., 5 – 2400 MHz	1		909 705	219
		F connector	1	47 – 2400 MHz	1		909 706	220
		IEC-/F connector	1	d.c. – 2400 MHz	2		909 300	210
UMTS		SMA	1	d.c. – 5.8 GHz	2		929 039	220
		BNC	1	d.c. – 4 GHz	2		929 042	220
		N connector	1	d.c. – 5.8 GHz	2		929 044	220
		N connector	1	d.c. – 2.5 GHz	1		929 045	220
		7/16 connector	1	d.c., 690 MHz – 2.7 GHz	1		929 146	221
		7/16 connector	1	690 MHz – 2.7 GHz	1		929 148	221

¹⁾ with universal base part BXT BAS (Part No. 920 300) or BSP BAS 4 (Part No. 926 304) please refer to page 158

²⁾ with universal base part BXT BAS EX (Part No. 920 301) please refer to page 170

Antenna systems, broadband systems, transmitting and receiving systems, video systems

Interface / Signal	For mounting on	Connection system	Protected lines	Frequency range	SPD class TYPE	SPD	Part No.	Page
Video (two-wire) 		Screw terminals	4	d.c. – 100 MHz	1		920 371 ¹⁾	161
		Screw terminals	2	d.c. – 100 MHz	1		920 271 ¹⁾	163
		Screw terminals	4	d.c. – 100 MHz	2		926 371 ¹⁾	169
		Screw terminals	2	d.c. – 100 MHz	2		926 271 ¹⁾	169
		RJ45	4 x 2	d.c. – 250 MHz	2		929 100	204
		RJ45	4 x 2	d.c. – 250 MHz	2		929 121	204
		RJ45	4 x 2	d.c. – 100 MHz	2		929 126	204
		Screw terminals	2	d.c. – 100 MHz	1		920 270 ¹⁾	163
		Screw terminals	2	d.c. – 100 MHz	2		926 270 ¹⁾	169
		LSA	20	d.c. – 90 MHz	1		907 401 + 907 465 + 907 498	189 191
Video digital (IP camera)		RJ45	4 x 2	d.c. – 250 MHz	2		929 100	204
		RJ45	4 x 2	d.c. – 250 MHz	2		929 121	204
		RJ45	4 x 2	d.c. – 100 MHz	2		929 126	204
		RJ45	4 x 2	d.c. – 250 MHz	2		929 221	203
Video analogue (coax)		BNC	1	d.c. – 300 MHz	2		929 010	218
		BNC	1	0 – 300 MHz	2		909 710 / 711	218
		BNC / Spring terminal	3 / 2 / 1	50 Hz / d.c.-250 MHz / 300 MHz	2		 928 440	182
WLAN (2.4 GHz band)		SMA	1	d.c. – 5.8 GHz	2		929 039	220
		BNC	1	d.c. – 4 GHz	2		929 042	220
		N connector	1	d.c. – 5.8 GHz	2		929 044	220
WLAN (5 GHz band)		SMA	1	d.c. – 5.8 GHz	2		929 039	218
		N connector	1	d.c. – 5.8 GHz	2		929 044	218



BLITZDUCTOR® XTU / DEHNbox actiVsense®

Universal lightning current / surge arrester with actiVsense technology

- Automatically detects the operating voltage
- Optimally adapts the voltage protection level to the voltage currently applied

Application:











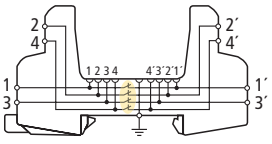

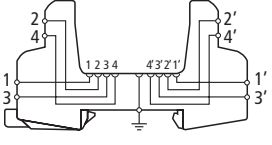



- Suitable for the vast majority of applications in information technology systems
 - Ideally suited for telecommunications systems, bus systems as well as measuring and control equipment
- ⇒ The nominal current of the SPD is limited to 100 mA, allowing the device to be used in the vast majority of information technology systems. In some applications where the signal line is also used for power supply the current may exceed 100 mA.
- ⇒ All signals are transmitted with signal frequencies up to 50 MHz.
- ⇒ In bus systems the SPD can be used for applications based on RS485/RS422 interfaces (not RS232).
- For more detailed information, please refer to page 165 (BXTU) and page 213 (DBX).

¹⁾ with universal base part BXT BAS (Part No. 920 300) or BSP BAS 4 (Part No. 926 304) please refer to page 158
²⁾ with universal base part BXT BAS EX (Part No. 920 301) please refer to page 170

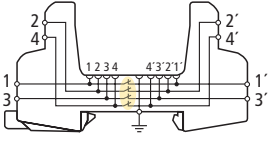

DEHN protects.®

Pluggable SPDs – DIN Rail mounted

Product	Basic circuit diagram / Symbol	Type	Part No.	Page
Basisteile BXT BAS / BSP BAS 4				
		BXT BAS – Universal base part for protection modules of the BLITZDUCTOR XT /XTU and BLITZDUCTOR SP series – No signal disconnection if the protection module is removed – Connection of up to four lines	920 300	158
		BSP BAS 4 Universal base part for protection modules of the BLITZDUCTOR XT /XTU and BLITZDUCTOR SP series – Signal disconnection if the protection module is removed – Connection of up to four lines	926 304	158
BLITZDUCTOR® XT				
	TYPE 1 P1 	BXT ML ... – Combined lightning current and surge arrester modules – With integrated LifeCheck – Two-pole and four-pole versions	920 XXX	159
	TYPE 1 P1	BXT M2 BD HC5A 24 – Combined lightning current and surge arrester module for protecting 1 pair of unearthed signal circuits – Optimal for protecting DC signal circuits up to 5 A nominal current – For controlling motor-driven actuators with high starting and operating currents	920 296	164
BLITZDUCTOR® XTU				
	TYPE 1 P1  	BXTU ML ... – Universal lightning current and surge arrester modules – With integrated LifeCheck – With integrated actiVsense technology – Two-pole and four-pole versions	920 349 920 249	166 166
BLITZDUCTOR® SP				
	TYPE 2 P1	BSP M ... – Surge arrester modules – Two-pole and four-pole versions	926 XXX	167
BLITZDUCTOR® XT Ex (i)				
		BXT BAS EX – Universal base part for protection modules of the BLITZDUCTOR XT Ex (i) series – No signal disconnection if the protection module is removed – Connection of up to four lines	920 301	170
	TYPE 2 P1  	BXT ML ... – Surge arrester modules for hazardous areas – With integrated LifeCheck – Two-pole and four-pole versions	920 XXX	171
	TYPE 2 P1 	BXT M2 BD EX 24 – Surge arrester modules for hazardous areas – Protection of one pair – Direct or indirect shielding optional	920 383	172



BLITZDUCTOR® – Base Parts

BXT BAS – Without signal disconnection / BSP BAS 4 – With signal disconnection

- Universal base parts for protection modules of the BLITZDUCTOR XT/XTU/SP series
- Two base parts with or without signal disconnection if the protection module is removed
- Connection of up to four lines



BXT BAS

The BLITZDUCTOR XT base part is an extremely space-saving and universal four-pole **feed-through terminal** for the insertion of a protection module **without** signal disconnection if the protection module is removed. The snap-in mechanism at the supporting foot of the base part allows the protection module to be safely earthed via the DIN rail. Since no components of the protective circuit are situated in the base part, maintenance operation is only required for the protection modules.

Type	BXT BAS
Part No.	920 300
For mounting on	35 mm DIN rails acc. to EN 60715
Cross-sectional area, solid	0.08-4 mm ²
Cross-sectional area, flexible	0.08-2.5 mm ²
Tightening torque (terminals)	0.4 Nm
Earthing via	35 mm DIN rails acc. to EN 60715
Approvals	CSA, UL, EAC, ATEX, IECEx *)

*) only in connection with an approved protection module

BSP BAS 4

The BLITZDUCTOR SP base part is an extremely space-saving and universal four-pole **terminal** for the insertion of a protection module **with** signal disconnection if the protection module is removed. The snap-in mechanism at the supporting foot of the base part allows the protection module to be safely earthed via the DIN rail. Since no components of the protective circuit are situated in the base part, maintenance operation is only required for the protection modules.



Type	BSP BAS 4
Part No.	926 304
For mounting on	35 mm DIN rails acc. to EN 60715
Cross-sectional area, solid	0.08-4 mm ²
Cross-sectional area, flexible	0.08-2.5 mm ²
Tightening torque (terminals)	0.4 Nm
Earthing via	35 mm DIN rails acc. to EN 60715
Approvals	UL, CSA, EAC *)

*) only in connection with an approved protection module



BLITZDUCTOR® XT

- Combined lightning current and surge arrester
 - Maximum discharge capacity for two-pole, three-pole or four-pole interfaces
 - Capable of carrying lightning currents up to 10 kA (10/350 μs)
 - Low voltage protection level, capable of protecting terminal equipment
- With integrated LifeCheck monitoring
 - Arrester testing during operation
 - Detection of pre-damaged arresters
 - High signal availability thanks to preventive replacement of arresters
- SPD consists of a protection module and a base part
 - Vibration and shock-tested for safe operation
 - All protection components integrated in the protection module
 - Two universal base parts with / without signal disconnection
 - Minimum space requirements, 4 single lines or 2 pairs over a width of 12 mm



BLITZDUCTOR XT with an earthing module (grey). The lines can be tested by means of the measuring module (grey with lines) without disconnecting the terminals.

Pluggable SPDs –
DIN Rail mounted

BLITZDUCTOR XT combined arresters are pluggable and universal multi-pole DIN rail mounted lightning current and surge arresters for protecting measuring and control circuits, bus systems and telecommunication systems. They are particularly useful in installations and systems with high requirement on the availability. To ensure effective protection of terminal equipment under lightning and overvoltage conditions, BLITZDUCTOR XT arresters combine the permanently high impulse current discharge capacity of a lightning current arrester with the low voltage protection level of a surge arrester.

LifeCheck allows quick and easy testing of arresters without ever removing the module from the system. Integrated in the protection modules, LifeCheck permanently monitors the operating state of the arrester and acts like an early warning system, detecting imminent electrical or thermal overload of the protection components. The status of the arrester can be

read in a second by the portable DEHNrecord LC reader with non-contact RFID technology. LifeCheck also saves and indicates the date of the last test of the protection module. Stationary installed, a condition monitoring system permanently monitors the condition of up to 10 BXT arresters.

The module locking system ensures safe operation. Thus, the arrester provides protection against vibration effects and shock up to a 30-fold acceleration of gravity. The function-optimised design of the arrester ensures both fast and easy replacement of protection modules which house all relevant protection elements.

A wide range of accessories makes BLITZDUCTOR XT arresters particularly easy to use. Elements for earthing unused lines or easily testing signal circuits round off the product range.

The **protection module** and **base part** must be ordered separately!



Two-part design with universal base part and application-specific protection module.



The module locking mechanism ensures that the module is vibration-proof and protected against polarity reversal.



All protection elements are integrated in the plug-in module and are monitored by means of LifeCheck.

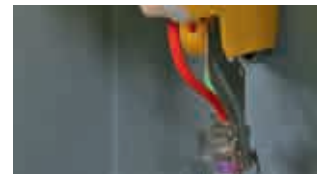

EMC spring terminal (accessory) for permanent low-impedance shield contact.

BLITZDUCTOR® XT – Protection Modules with LifeCheck®

BXT ML4 B 180

Space-saving four-pole lightning current arrester module with LifeCheck feature for almost all applications. For use in connection with downstream **TYPE 2 P1** surge arresters or combined lightning current and surge arresters with a lower or equal voltage level.

Type BXT ...	ML4 B 180
Part No.	920 310
SPD class	TYPE 2 P1
Max. continuous operating voltage (d.c.) (U _c)	180 V
Nominal current at 45 °C (I _n)	1.2 A
D1 Total lightning impulse current (10/350 μs) (I _{imp})	10 kA
C2 Total nominal discharge current (8/20 μs) (I _n)	20 kA
Series resistance per line	0.4 ohm(s)
Approvals	CSA, EAC, ATEX, IECEx, CSA & USA Hazloc, SIL

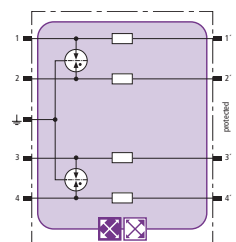

BXT ML4 BE 5 – BE 180

Space-saving combined lightning current and surge arrester module with LifeCheck feature for protecting four single lines sharing a common reference potential as well as unbalanced interfaces.

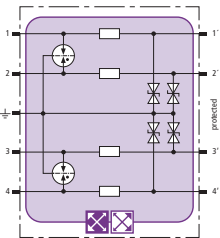

General Information:	
D1 Total lightning impulse current (10/350 μ s) (I_{imp})	10 kA
C2 Total nominal discharge current (8/20 μ s) (I_n)	20 kA

Type BXT ...	ML4 BE 5	ML4 BE 12	ML4 BE 24	ML4 BE 36
Part No.	920 320	920 322	920 324	920 336
SPD class	TYPE 1 P1	TYPE 1 P1	TYPE 1 P1	TYPE 1 P1
Max. continuous operating voltage (d.c.) (U_c)	6 V	15 V	33 V	45 V
Nominal current at 45 °C (I_L)	1.0 A	0.75 A	0.75 A	1.8 A
Series resistance per line	1.0 ohm(s)	1.8 ohm(s)	1.8 ohm(s)	0.43 ohm(s)
Cut-off frequency line-PG (f_G)	1.0 MHz	2.7 MHz	6.8 MHz	3.8 MHz
Approvals	CSA, UL, EAC, ATEX, IECEx, CSA & USA Hazloc, SIL	CSA, UL, EAC, ATEX, IECEx, CSA & USA Hazloc, SIL	CSA, UL, EAC, ATEX, IECEx, CSA & USA Hazloc, SIL	UL, EAC, ATEX, IECEx, CSA & USA Hazloc, SIL

Type BXT ...	ML4 BE 48	ML4 BE 60	ML4 BE 180
Part No.	920 325	920 326	920 327
SPD class	TYPE 1 P1	TYPE 1 P1	TYPE 1 P2
Max. continuous operating voltage (d.c.) (U_c)	54 V	70 V	180 V
Nominal current at 45 °C (I_L)	0.75 A	1.0 A	1.0 A
Series resistance per line	1.8 ohm(s)	1.0 ohm(s)	1.0 ohm(s)
Cut-off frequency line-PG (f_G)	8.7 MHz	9.0 MHz	25.0 MHz
Approvals	CSA, UL, EAC, ATEX, IECEx, CSA & USA Hazloc, SIL	CSA, UL, EAC, ATEX, IECEx, CSA & USA Hazloc, SIL	CSA, UL, EAC, ATEX, IECEx, CSA & USA Hazloc, SIL

BXT ML4 BD 5 – BD 180

Space-saving combined lightning current and surge arrester module with LifeCheck feature for protecting two pairs of unearthed balanced interfaces.

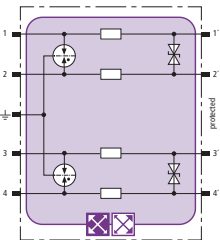

General Information:	
D1 Total lightning impulse current (10/350 μ s) (I_{imp})	10 kA
C2 Total nominal discharge current (8/20 μ s) (I_n)	20 kA
Approvals	CSA, UL, EAC, ATEX, IECEx, CSA & USA Hazloc, SIL

Type BXT ...	ML4 BD 5	ML4 BD 12	ML4 BD 24
Part No.	920 340	920 342	920 344
SPD class	TYPE 1 P1	TYPE 1 P1	TYPE 1 P1
Max. continuous operating voltage (d.c.) (U_c)	6.0 V	15 V	33 V
Nominal current at 45 °C (I_L)	1.0 A	1.0 A	1.0 A
Series resistance per line	1.0 ohm(s)	1.0 ohm(s)	1.0 ohm(s)
Cut-off frequency line-line (f_G)	1.0 MHz	2.8 MHz	7.8 MHz

Type BXT ...	ML4 BD 48	ML4 BD 60	ML4 BD 180
Part No.	920 345	920 346	920 347
SPD class	TYPE 1 P1	TYPE 1 P1	TYPE 1 P2
Max. continuous operating voltage (d.c.) (U_c)	54 V	70 V	180 V
Nominal current at 45 °C (I_L)	1.0 A	1.0 A	0.75 A
Series resistance per line	1.0 ohm(s)	1.0 ohm(s)	1.8 ohm(s)
Cut-off frequency line-line (f_G)	8.7 MHz	11.0 MHz	25.0 MHz

BXT ML4 BPD 24

Space-saving combined arrester module with LifeCheck feature for protecting two pairs in 24 V d.c. systems. Can also be used for systems with earthed negative poles. Integrated PTC resistors allow to reliably reset the arrester after the system circuit has been affected by short-circuit currents up to 40 A.

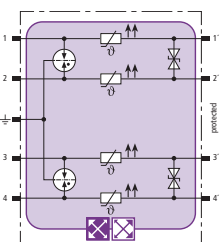

Type BXT ...	ML4 BPD 24
Part No.	920 314
SPD class	TYPE 1 P1
Max. continuous operating voltage (d.c.) (U_c)	33 V
Nominal current at 70 °C (I_L)	0.1 A
D1 Total lightning impulse current (10/350 μ s) (I_{imp})	10 kA
C2 Total nominal discharge current (8/20 μ s) (I_n)	20 kA
Series resistance per line	typ. 10 ohm(s)
Cut-off frequency line-line (f_G)	4 MHz
Approvals	EAC, SIL

BXT ML4 BC 5 / 24

Space-saving combined lightning current and surge arrester module with LifeCheck feature for protecting up to four unearthed single lines sharing a common reference potential.

Type BXT ...	ML4 BC 5	ML4 BC 24
Part No.	920 350	920 354
SPD class	TYPE 1P1	TYPE 1P1
Max. continuous operating voltage (d.c.) (U_c)	6.0 V	33 V
Nominal current at 45 °C (I_n)	1.0 A	0.75 A
D1 Total lightning impulse current (10/350 μ s) (I_{imp})	10 kA	10 kA
C2 Total nominal discharge current (8/20 μ s) (I_n)	20 kA	20 kA
Series resistance per line	1.0 ohm(s)	1.8 ohm(s)
Cut-off frequency line-line (f_c)	1.0 MHz	5.7 MHz
Approvals	CSA, EAC, ATEX, IECEx, CSA & USA Hazloc, SIL	CSA, EAC, ATEX, IECEx, CSA & USA Hazloc, SIL

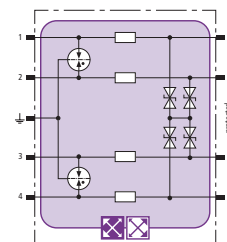

Pluggable SPDs –
DIN Rail mounted

BXT ML4 BE C 12 / 24

Space-saving combined lightning current and surge arrester module with LifeCheck feature for protecting two pairs of balanced interfaces with diode protective circuit at the input, current loops (TTY) and optocoupler inputs.

Type BXT ...	ML4 BE C 12	ML4 BE C 24
Part No.	920 362	920 364
SPD class	TYPE 1P1	TYPE 1P1
Max. continuous operating voltage (d.c.) (U_c)	15 V	33 V
Nominal current at 80 °C (I_n)	0.1 A	0.1 A
D1 Total lightning impulse current (10/350 μ s) (I_{imp})	10 kA	10 kA
C2 Total nominal discharge current (8/20 μ s) (I_n)	20 kA	20 kA
Series resistance per line	13.8 ohm(s)	28.8 ohm(s)
Cut-off frequency line-PG (f_c)	0.85 MHz	1.7 MHz
Approvals	EAC, ATEX, IECEx, CSA & USA Hazloc, SIL	CSA, EAC, ATEX, IECEx, CSA & USA Hazloc, SIL

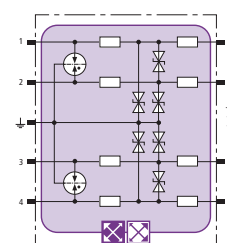

BXT ML4 BE HF 5

Space-saving combined lightning current and surge arrester module with LifeCheck feature for protecting four single lines sharing a common reference potential as well as high-frequency transmissions without galvanic isolation.

Type BXT ...	ML4 BE HF 5
Part No.	920 370
SPD class	TYPE 1P1
Max. continuous operating voltage (d.c.) (U_c)	6.0 V
Nominal current at 45 °C (I_n)	1.0 A
D1 Total lightning impulse current (10/350 μ s) (I_{imp})	10 kA
C2 Total nominal discharge current (8/20 μ s) (I_n)	20 kA
Series resistance per line	1.0 ohm(s)
Cut-off frequency line-PG (f_c)	100.0 MHz
Approvals	CSA, UL, EAC, ATEX, IECEx, CSA & USA Hazloc, SIL

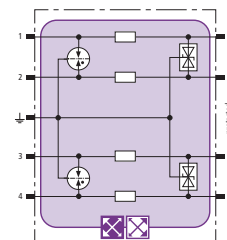

BXT ML4 BD HF 5 / 24

Space-saving combined lightning current and surge arrester module with LifeCheck feature for protecting two pairs in unearthed high-frequency bus systems or two-wire video transmission systems.

Type BXT ...	ML4 BD HF 5	ML4 BD HF 24
Part No.	920 371	920 375
SPD class	TYPE 1P1	TYPE 1P1
Max. continuous operating voltage (d.c.) (U_c)	6.0 V	33 V
Nominal current at 45 °C (I_n)	1.0 A	1.0 A
D1 Total lightning impulse current (10/350 μ s) (I_{imp})	10 kA	10 kA
C2 Total nominal discharge current (8/20 μ s) (I_n)	20 kA	20 kA
Series resistance per line	1.0 ohm(s)	1.0 ohm(s)
Cut-off frequency line-line (f_c)	100.0 MHz	100.0 MHz
Approvals	CSA, UL, EAC, ATEX, IECEx, CSA & USA Hazloc, SIL	CSA, UL, EAC, ATEX, IECEx, CSA & USA Hazloc, SIL

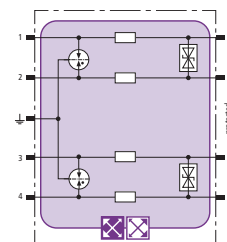



BXT ML4 MY 110 / 250

Space-saving surge arrester module with LifeCheck feature for protecting four lines of stranded signal interfaces.

Type BXT ...	ML4 MY 110	ML4 MY 250
Part No.	920 388	920 389
SPD class	TYPE 2P2	TYPE 2P3
Max. continuous operating voltage (d.c.) line-line (U_C)	170 V	620 V
Max. continuous operating voltage (d.c.) line-PG (U_C)	85 V	320 V
Nominal current at 80 °C (I_L)	3.0 A	3.0 A
C2 Total nominal discharge current (8/20 μ s) (I_n)	10 kA	10 kA
Cut-off frequency line-line (f_G)	4.5 MHz	20.0 MHz
Approvals	EAC, SIL	EAC, SIL

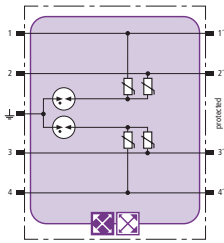

Pluggable SPDs –
DIN Rail mounted



NEW

BXT ML4 BE BD 24

Space-saving LifeCheck-equipped surge arrester module for protecting two single lines with common reference potential as well as unbalanced interfaces and one pair of unearthed balanced interfaces.

Type BXT ...	ML4 BE BD 24
Part No.	920 334 NEW
SPD class	TYPE 1P1
Max. continuous operating voltage (d.c.) (U_C)	33 V
Nominal current at 45 °C (I_L)	0.75 A
D1 Total lightning impulse current (10/350 μ s) (I_{imp})	10 kA
C2 Total nominal discharge current (8/20 μ s) (I_n)	20 kA

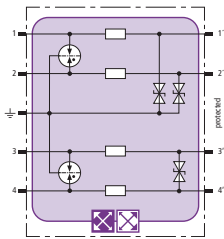

BXT ML2 BD 180

Space-saving combined lightning current and surge arrester module with LifeCheck feature for protecting one pair of unearthed balanced interfaces.

Type BXT ...	ML2 BD 180
Part No.	920 247
SPD class	TYPE 1P2
Max. continuous operating voltage (d.c.) (U_C)	180 V
Nominal current at 45 °C (I_L)	0.75 A
D1 Total lightning impulse current (10/350 μ s) (I_{imp})	5 kA
C2 Total nominal discharge current (8/20 μ s) (I_n)	20 kA
Series resistance per line	1.8 ohm(s)
Cut-off frequency line-line (f_G)	25.0 MHz
Approvals	CSA, EAC, ATEX, IECEx, CSA & USA Hazloc, SIL

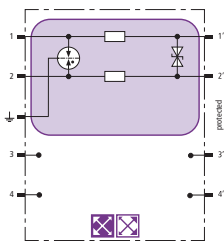

BXT ML2 BD S 5 – BD S 48

Space-saving combined lightning current and surge arrester module with LifeCheck feature for protecting one pair of unearthed balanced interfaces with direct or indirect shield earthing.

Type BXT ...	ML2 BD S 5	ML2 BD S 12	ML2 BD S 24	ML2 BD S 48
Part No.	920 240	920 242	920 244	920 245
SPD class	TYPE 1P1	TYPE 1P1	TYPE 1P1	TYPE 1P1
Max. continuous operating voltage (d.c.) (U_C)	6.0 V	15 V	33 V	54 V
Nominal current at 45 °C (I_L)	1.0 A	1.0 A	1.0 A	1.0 A
D1 Total lightning impulse current (10/350 μ s) (I_{imp})	9 kA	9 kA	9 kA	9 kA
C2 Total nominal discharge current (8/20 μ s) (I_n)	20 kA	20 kA	20 kA	20 kA
Series resistance per line	1.0 ohm(s)	1.0 ohm(s)	1.0 ohm(s)	1.0 ohm(s)
Cut-off frequency line-line (f_G)	1.0 MHz	2.8 MHz	7.8 MHz	8.7 MHz
Approvals	CSA, EAC, ATEX, IECEx, CSA & USA Hazloc, SIL	CSA, EAC, ATEX, IECEx, CSA & USA Hazloc, SIL	CSA, EAC, ATEX, IECEx, CSA & USA Hazloc, SIL	CSA, EAC, ATEX, IECEx, CSA & USA Hazloc, SIL

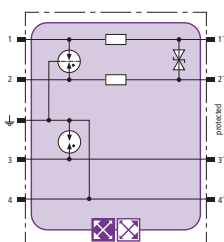

Pluggable SPDs – DIN Rail mounted

BXT ML2 BE S 5 – BE S 48

Space-saving combined lightning current and surge arrester module with LifeCheck feature for protecting two single lines sharing a common reference potential as well as unbalanced interfaces, with direct or indirect shield earthing.

General Information:				
SPD class		TYPE 1 P1		
D1 Total lightning impulse current (10/350 μ s) (I_{imp})		9 kA		
C2 Total nominal discharge current (8/20 μ s) (I_n)		20 kA		
Type BXT ...		ML2 BE S 5	ML2 BE S 12	ML2 BE S 24
Part No.		920 220	920 222	920 224
Max. continuous operating voltage (d.c.) (U_c)		6.0 V	15 V	33 V
Nominal current at 45 °C (I_L)		1.0 A	0.75 A	0.75 A
Series resistance per line		1.0 ohm(s)	1.8 ohm(s)	1.8 ohm(s)
Cut-off frequency line-PG (f_G)		1.0 MHz	2.7 MHz	6.8 MHz
Approvals		CSA, EAC, ATEX, IECEx, CSA & USA Hazloc, SIL		
Type BXT ...		ML2 BE S 36	ML2 BE S 48	
Part No.		920 226	920 225	
Max. continuous operating voltage (d.c.) (U_c)		45 V	54 V	
Nominal current at 45 °C (I_L)		1.8 A	0.75 A	
Series resistance per line		0.43 ohm(s)	1.8 ohm(s)	
Cut-off frequency line-PG (f_G)		3.8 MHz	8.7 MHz	
Approvals		UL, EAC, SIL	CSA, UL, EAC, ATEX, IECEx, CSA & USA Hazloc, SIL	

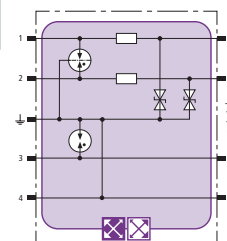

Pluggable SPDs –
DIN Rail mounted

BXT ML2 BE HFS 5

Space-saving combined lightning current and surge arrester module with LifeCheck feature for protecting one pair in high-frequency transmissions without galvanic isolation, with direct or indirect shield earthing.

Type BXT ...	ML2 BE HFS 5
Part No.	920 270
SPD class	TYPE 1 P1
Max. continuous operating voltage (d.c.) (U_c)	6.0 V
Nominal current at 45 °C (I_L)	1.0 A
D1 Total lightning impulse current (10/350 μ s) (I_{imp})	9 kA
C2 Total nominal discharge current (8/20 μ s) (I_n)	20 kA
Series resistance per line	1.0 ohm(s)
Cut-off frequency line-PG (f_G)	100.0 MHz
Approvals	CSA, UL, EAC, ATEX, IECEx, CSA & USA Hazloc, SIL

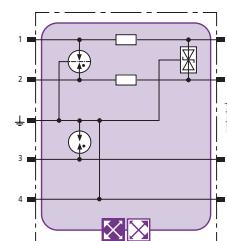

BXT ML2 BD HFS 5

Space-saving combined lightning current and surge arrester module with LifeCheck feature for protecting one pair in unearthed high-frequency bus systems or video transmission systems, with direct or indirect shield earthing.

Type BXT ...	ML2 BD HFS 5
Part No.	920 271
SPD class	TYPE 1 P1
Max. continuous operating voltage (d.c.) (U_c)	6.0 V
Nominal current at 45 °C (I_L)	1.0 A
D1 Total lightning impulse current (10/350 μ s) (I_{imp})	9 kA
C2 Total nominal discharge current (8/20 μ s) (I_n)	20 kA
Series resistance per line	1.0 ohm(s)
Cut-off frequency line-line (f_G)	100.0 MHz
Approvals	CSA, UL, EAC, ATEX, IECEx, CSA & USA Hazloc, SIL

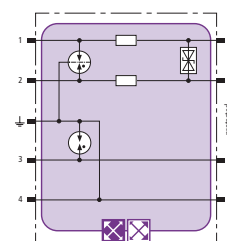

BXT ML2 B 180

Space-saving two-pole lightning current arrester module with LifeCheck feature and shield earthing for almost all applications. For use in conjunction with downstream **TYPE 2 P1** surge arresters or combined lightning current and surge arresters with a lower or equal voltage level.

Type BXT ...	ML2 B 180
Part No.	920 211
SPD class	TYPE 1 P1
Max. continuous operating voltage (d.c.) (U_c)	180 V
Nominal current at 45 °C (I_L)	1.2 A
D1 Total lightning impulse current (10/350 μ s) (I_{imp})	10 kA
C2 Total nominal discharge current (8/20 μ s) (I_n)	20 kA
Series resistance per line	0.4 ohm(s)
Approvals	CSA, EAC, ATEX, IECEx, CSA & USA Hazloc, SIL

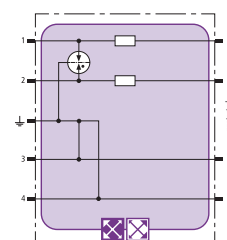



BXT ML2 BD DL S 15

Space-saving combined lightning current and surge arrester module with LifeCheck feature for protecting one pair of unearthed balanced interfaces, which specifically fulfils the requirements of Dupline buses, direct or indirect shield earthing.

Pluggable SPDs –
DIN Rail mounted

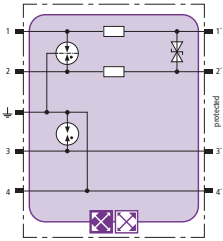

Type BXT ...	ML2 BD DL S 15
Part No.	920 243
SPD class	TYPE 1 P1
Max. continuous operating voltage (d.c.) (U_C)	17 V
Nominal current at 70 °C (I_L)	0.4 A
D1 Total lightning impulse current (10/350 μ s) (I_{imp})	9 kA
C2 Total nominal discharge current (8/20 μ s) (I_n)	20 kA
Series resistance per line	2.2 ohm(s)
Cut-off frequency line-line (f_G)	2.7 MHz
Approvals	EAC, ATEX, IECEx, CSA & USA Hazloc, SIL



BXT ML2 MY 250

Space-saving surge arrester module with LifeCheck feature for protecting two lines of stranded signal interfaces up to 250 V a.c.

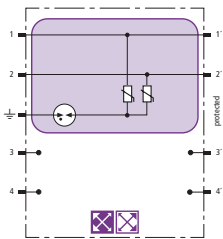

Type BXT ...	ML2 MY 250
Part No.	920 289
SPD class	TYPE 2 P3
Max. continuous operating voltage (d.c.) line-line (U_C)	620 V
Max. continuous operating voltage (d.c.) line-PG (U_C)	320 V
Nominal current at 80 °C (I_L)	3.0 A
C2 Total nominal discharge current (8/20 μ s) (I_n)	5 kA
Cut-off frequency line-line (f_G)	20.0 MHz
Approvals	EAC, SIL



BXT ML2 MY E 110

Space-saving surge arrester module with LifeCheck feature for protecting two pairs of stranded signal interfaces.

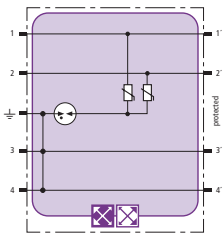

Type BXT ...	ML2 MY E 110
Part No.	920 288
SPD class	TYPE 2 P2
Max. continuous operating voltage (d.c.) line-line (U_C)	170 V
Max. continuous operating voltage (d.c.) line-PG (U_C)	85 V
Nominal current at 80 °C (I_L)	3.0 A
C2 Total nominal discharge current (8/20 μ s) (I_n)	5 kA
Series resistance per line	0 ohm(s)
Cut-off frequency line-line (f_G)	4.5 MHz
Approvals	EAC, SIL

BLITZDUCTOR® XT – Protection Module

NEW



BXT M2 BD HC5A 24

Space-saving combined arrester module for protecting one pair of unearthed balanced interfaces. Module is adapted to interfaces with DC currents up to 5 A, e.g. for the controller of motor-driven actuators with high starting and operating currents.

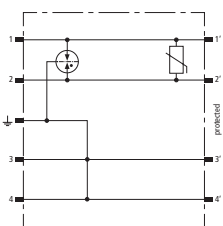

Type BXT ...	M2 BD HC5A 24
Part No.	920 296 ^{NEW}
SPD class	TYPE 1 P1
Max. continuous operating voltage (d.c.) (U_C)	36 V
Nominal current (I_L)	5 A
D1 Total lightning impulse current (10/350 μ s) (I_{imp})	5 kA
C2 Total nominal discharge current (8/20 μ s) (I_n)	20 kA
Series resistance per line	0 ohm(s)
Approvals	SIL



BLITZDUCTOR® XTU

- **Combined lightning current and surge arrester**
 - Max. discharge capacity for balanced data interfaces
 - Capable of carrying lightning currents up to 10 kA (10/350 μ s)
 - For installation in conformity with the lightning protection zone concept at the boundaries from $0_A - 2$ and higher
- **With actiVsense® technology**
 - Automatically detects the signal voltage ranging from 0 to 180 V
 - Optimally adapts the voltage protection level to the currently applied signal
 - Capable of protecting terminal equipment due to adapted voltage protection level
 - One arrester type for two different data interfaces
- **Integrated LifeCheck monitoring function**
 - Arresters can be tested without downtime
 - Detection of pre-damaged arresters
 - High signal availability due to preventive replacement of arresters
- **Arrester consists of a protection module and a base part**
 - For DIN rail mounting with a standard base part
 - Easy replacement of protection modules
 - Vibration and shock-tested for safe operation
 - Two universal base parts with / without signal disconnection



BLITZDUCTOR XTU for protecting different balanced signal and data interfaces. Space-saving two-part design comprising a base part and a protection module for DIN rail mounting.

The compact BLITZDUCTOR XTU combined lightning current and surge arrester is designed for protecting information and automation equipment and systems and distinguishes itself through its unique actiVsense technology. The arrester does not have a specific nominal voltage and can thus be used for all voltages from 0 to 180 V with a superimposed signal voltage (± 5 V/50 MHz). The nominal current is limited to 100 mA which is completely sufficient for information technology systems.

Its innovative actiVsense technology allows the arrester to detect the signal voltage and to automatically adapt the voltage protection level to this voltage. This makes the arrester ideal for applications where changing or slowly fluctuating signal levels (≤ 400 Hz) are to be expected. In case of interference, BLITZDUCTOR XTU arresters always provide a minimal residual voltage for every signal voltage and therefore afford maximum protection for the devices and system circuits connected to them.

BLITZDUCTOR XTU is available in two versions. The four-pole version provides protection for two separate balanced interfaces, that is the arrester automatically detects the operating / signal voltage for every pair and optimally adapts the voltage protection level for every signal circuit. This allows to protect two different balanced interfaces by means of a single arrester, thus reducing installation time, saving costs and reducing the number of arresters to be used. If only one signal interface is to be protected, a two-pole version can be used for a balanced data interface (one pair). This version also allows to directly or indirectly connect cable shields to the equipotential bonding.

This DIN rail mounted arrester is ideally suited for use in information technology transmission systems such as telecommunication, bus or measuring and control systems.

The **protection module** and **base part** must be ordered separately!

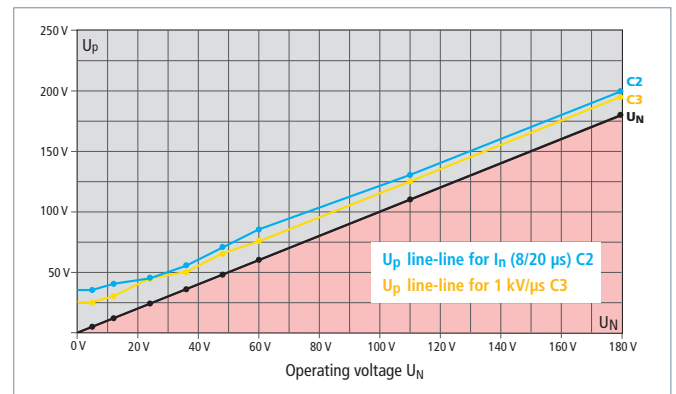

Voltage protection level diagram BXTU



Optimally adapted voltage protection level with integrated actiVsense® technology ensures protection of terminal equipment.



The protection module of the pluggable arrester safely snaps into the base part, thus ensuring vibration and shock resistance.



To ensure high availability of the signal circuits, the integrated LifeCheck feature allows to quickly check whether arresters are pre-damaged.



DIN rail mounting by means of integrated earthing contact.

BLITZDUCTOR® XTU – Protection Modules with LifeCheck®

Pluggable SPDs –
DIN Rail mounted

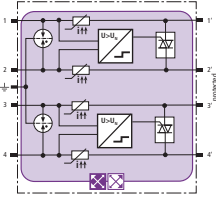

BXTU ML4 BD 0-180

Space-saving combined lightning current and surge arrester module with actiVsense and LifeCheck technology for protecting two pairs (same or different operating voltage) of balanced interfaces with galvanic isolation.

Type BXTU ...	ML4 BD 0-180
Part No.	920 349
SPD class	TYPE 1 P1
Max. continuous operating voltage (d.c.) (U_c)	180 V
Permissible superimposed signal voltage (U_{signal})	$\leq \pm 5$ V
Cut-off frequency line-line (U_{signal} , balanced 100 ohms) (f_c)	50 MHz
Nominal current at 80 °C (equal to max. short-circuit current) (I_n)	100 mA
D1 Total lightning impulse current (10/350 μ s) (I_{imp})	10 kA
C2 Total nominal discharge current (8/20 μ s) (I_n)	20 kA
Series resistance per line	≤ 10 ohms; typically 7.5 ohms
Approvals	CSA, UL, EAC, SIL

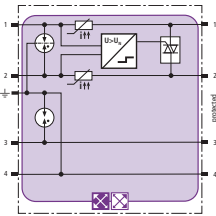

BXTU ML2 BD S 0-180

Space-saving combined lightning current and surge arrester module with actiVsense and LifeCheck technology for protecting one pair of balanced interfaces with galvanic isolation. Direct or indirect shield earthing.

Type BXTU ...	ML2 BD S 0-180
Part No.	920 249
SPD class	TYPE 1 P1
Max. continuous operating voltage (d.c.) (U_c)	180 V
Permissible superimposed signal voltage (U_{signal})	$\leq \pm 5$ V
Cut-off frequency line-line (U_{signal} , balanced 100 ohms) (f_c)	50 MHz
Nominal current at 80 °C (equal to max. short-circuit current) (I_n)	100 mA
D1 Total lightning impulse current (10/350 μ s) (I_{imp})	9 kA
C2 Total nominal discharge current (8/20 μ s) (I_n)	20 kA
Series resistance per line	≤ 10 ohms; typically 7.5 ohms
Approvals	CSA, UL, EAC, SIL



BLITZDUCTOR® SP

- **Universal surge arrester**
 - Universal surge arrester for two-pole, three-pole or four-pole interfaces
 - High discharge capacity up to 20 kA (8/20 μs)
 - Low voltage protection level, capable of protecting terminal equipment
- **Arrester consists of a protection module and a base part**
 - Easy replacement of protection modules
 - All protection components integrated in the protection module
 - Two universal base parts with or without signal disconnection
- **Functional and appealing design**
 - DIN rail mounted device with integrated earthing
 - Minimum space requirements, four single lines or two pairs over a width 12 mm
 - Vibration and shock-tested for safe operation



Pluggable and universal multipole surge arrester for use in information technology systems.

BLITZDUCTOR SP arresters are pluggable and universal multipole DIN rail mounted surge arresters for protecting measuring and control circuits, bus systems, emergency alarm systems or telecommunication systems. BLITZDUCTOR SP arresters combine a permanently high impulse current discharge capacity with an extremely low voltage protection level, thus ensuring effective protection of terminal equipment even in case of interference caused by impulse currents and surges resulting from switching operations.

The arresters provide protection against vibration effects and shock up to a 30-fold acceleration of gravity. The function-optimised arrester design ensures both fast and easy replacement of protection modules which house all relevant protection elements. A wide range of accessories e.g. for earthing unused lines or easily testing lines round off the product range. The protection module and base part have to be ordered separately!



Two-part design comprising a base part and a protection module.



The module locking mechanism ensures that the module is vibration-proof and protected against polarity reversal.



All protection elements are integrated in the plug-in module.



Two universal base parts with or without signal disconnection if the protection module is removed.

BLITZDUCTOR® SP – Protection Modules

BSP M4 BE 5 – BE 180

Space-saving surge arrester module for protecting four single lines sharing a common reference potential and unbalanced interfaces.

General Information:				
D1 Lightning impulse current (10/350 μs) per line (I _{imp})	1 kA			
C2 Total nominal discharge current (8/20 μs) (I _n)	20 kA			
Type BSP ...	M4 BE 5	M4 BE 12	M4 BE 24	
Part No.	926 320	926 322	926 324	
SPD class	TYPE 2 P1	TYPE 2 P1	TYPE 2 P1	
Max. continuous operating voltage (d.c.) (U _c)	6.0 V	15 V	33 V	
Nominal current at 45 °C (I _n)	1.0 A	0.75 A	0.75 A	
Cut-off frequency line-PG (f _c)	1.0 MHz	2.7 MHz	6.8 MHz	
Approvals	UL, CSA, SIL, EAC	UL, CSA, SIL, EAC	UL, CSA, SIL, EAC	
Type BSP ...	M4 BE 48	M4 BE 60	M4 BE 180	
Part No.	926 325	926 326	926 327	
SPD class	TYPE 2 P1	TYPE 2 P1	TYPE 2 P2	
Max. continuous operating voltage (d.c.) (U _c)	54 V	70 V	180 V	
Nominal current at 45 °C (I _n)	0.75 A	1.0 A	1.0 A	
Cut-off frequency line-PG (f _c)	8.7 MHz	9.0 MHz	25.0 MHz	
Approvals	UL, CSA, SIL, EAC	UL, CSA, SIL, EAC	UL, CSA, SIL, EAC	

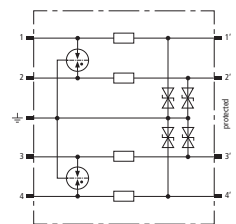

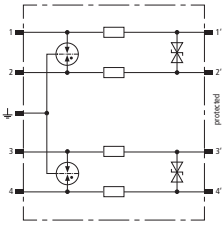

BSP M4 BD 5 – BD 180

Space-saving surge arrester module for protecting two pairs of balanced interfaces with galvanic isolation.

General Information:			
D1 Lightning impulse current (10/350 μ s) per line (I_{imp})	1 kA		
C2 Total nominal discharge current (8/20 μ s) (I_n)	20 kA		
Approvals	UL, CSA, SIL, EAC		
Type BSP ...	M4 BD 5	M4 BD 12	M4 BD 24
Part No.	926 340	926 342	926 344
SPD class	TYPE 2 P1		
Max. continuous operating voltage (d.c.) (U_c)	6.0 V	15 V	33 V
Nominal current at 45 °C (I_L)	1.0 A	1.0 A	1.0 A
Cut-off frequency line-line (f_G)	1.0 MHz	2.8 MHz	7.8 MHz
Type BSP ...	M4 BD 48	M4 BD 60	M4 BD 180
Part No.	926 345	926 346	926 347
SPD class	TYPE 2 P1		
Max. continuous operating voltage (d.c.) (U_c)	54 V	70 V	180 V
Nominal current at 45 °C (I_L)	1.0 A	1.0 A	0.75 A
Cut-off frequency line-line (f_G)	8.7 MHz	11.0 MHz	25.0 MHz

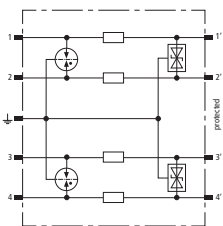

BSP M4 BE HF 5

Space-saving surge arrester module for protecting four single lines sharing a common reference potential and high-frequency transmissions without galvanic isolation.

Type BSP ...	M4 BE HF 5
Part No.	926 370
SPD class	TYPE 2 P1
Max. continuous operating voltage (d.c.) (U_c)	6.0 V
Nominal current at 45 °C (I_L)	1.0 A
D1 Lightning impulse current (10/350 μ s) per line (I_{imp})	1 kA
C2 Total nominal discharge current (8/20 μ s) (I_n)	20 kA
Cut-off frequency line-PG (f_G)	100.0 MHz
Approvals	UL, CSA, SIL, EAC

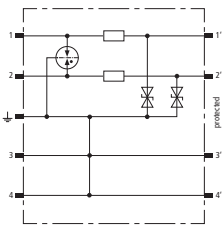

BSP M2 BE 5 – BE 180

Space-saving surge arrester module for protecting two single lines sharing a common reference potential and unbalanced interfaces.

General Information:			
D1 Lightning impulse current (10/350 μ s) per line (I_{imp})	1 kA		
C2 Total nominal discharge current (8/20 μ s) (I_n)	20 kA		
Approvals	UL, CSA, SIL, EAC		
Type BSP ...	M2 BE 5	M2 BE 12	M2 BE 24
Part No.	926 220	926 222	926 224
SPD class	TYPE 2 P1		
Max. continuous operating voltage (d.c.) (U_c)	6.0 V	15 V	33 V
Nominal current at 45 °C (I_L)	1.0 A	0.75 A	0.75 A
Cut-off frequency line-PG (f_G)	1.0 MHz	2.7 MHz	6.8 MHz
Type BSP ...	M2 BE 48	M2 BE 60	M2 BE 180
Part No.	926 225	926 226	926 227
SPD class	TYPE 2 P1		
Max. continuous operating voltage (d.c.) (U_c)	54 V	70 V	180 V
Nominal current at 45 °C (I_L)	0.75 A	1.0 A	1.0 A
Cut-off frequency line-PG (f_G)	8.7 MHz	9.0 MHz	25 MHz

BSP M4 BD HF 5 / 24

Space-saving surge arrester module for protecting two pairs of high-frequency bus systems or video transmission systems with galvanic isolation.

Type BSP ...	M4 BD HF 5	M4 BD HF 24
Part No.	926 371	926 375
SPD class	TYPE 2 P1	TYPE 2 P1
Max. continuous operating voltage (d.c.) (U_c)	6.0 V	33 V
Nominal current at 45 °C (I_n)	1.0 A	1.0 A
D1 Lightning impulse current (10/350 μ s) per line (I_{imp})	1 kA	1 kA
C2 Total nominal discharge current (8/20 μ s) (I_n)	20 kA	20 kA
Cut-off frequency line-line (f_G)	100.0 MHz	100.0 MHz
Approvals	UL, CSA, SIL, EAC	UL, CSA, EAC

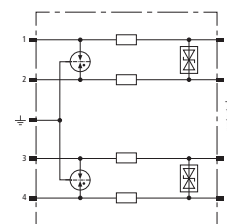

Pluggable SPDs –
DIN Rail mounted

BSP M2 BD 5 – BD 180

Space-saving surge arrester module for protecting one pair of balanced interfaces with galvanic isolation.

General Information:	
D1 Lightning impulse current (10/350 μ s) per line (I_{imp})	1 kA
C2 Total nominal discharge current (8/20 μ s) (I_n)	20 kA
Approvals	UL, CSA, SIL, EAC

Type BSP ...	M2 BD 5	M2 BD 12	M2 BD 24
Part No.	926 240	926 242	926 244
SPD class	TYPE 2 P1	TYPE 2 P1	TYPE 2 P1
Max. continuous operating voltage (d.c.) (U_c)	6.0 V	15 V	33 V
Nominal current at 45 °C (I_n)	1.0 A	1.0 A	1.0 A
Cut-off frequency line-line (f_G)	1.0 MHz	2.8 MHz	7.8 MHz

Type BSP ...	M2 BD 48	M2 BD 60	M2 BD 180
Part No.	926 245	926 246	926 247
SPD class	TYPE 2 P1	TYPE 2 P1	TYPE 2 P2
Max. continuous operating voltage (d.c.) (U_c)	54 V	70 V	180 V
Nominal current at 45 °C (I_n)	1.0 A	1.0 A	0.75 A
Cut-off frequency line-line (f_G)	8.7 MHz	11 MHz	25.0 MHz

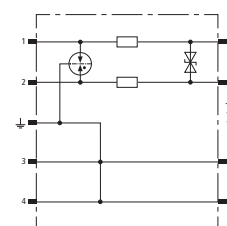

BSP M2 BE HF 5

Space-saving surge arrester module for protecting two single lines sharing a common reference potential and high-frequency transmissions without galvanic isolation.

Type BSP ...	M2 BE HF 5
Part No.	926 270
SPD class	TYPE 2 P1
Max. continuous operating voltage (d.c.) (U_c)	6.0 V
Nominal current at 45 °C (I_n)	1.0 A
D1 Lightning impulse current (10/350 μ s) per line (I_{imp})	1 kA
C2 Total nominal discharge current (8/20 μ s) (I_n)	20 kA
Cut-off frequency line-PG (f_G)	100 MHz
Approvals	UL, CSA, SIL, EAC

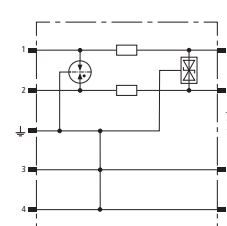

BSP M2 BD HF 5 / 24

Space-saving surge arrester module for protecting one pair of high-frequency bus systems or video transmission systems with galvanic isolation.

Type BSP ...	M2 BD HF 5	M2 BD HF 24
Part No.	926 271	926 275
SPD class	TYPE 2 P1	TYPE 2 P1
Max. continuous operating voltage (d.c.) (U_c)	6.0 V	33 V
Nominal current at 45 °C (I_n)	1.0 A	1.0 A
D1 Lightning impulse current (10/350 μ s) per line (I_{imp})	1 kA	1 kA
C2 Total nominal discharge current (8/20 μ s) (I_n)	20 kA	20 kA
Cut-off frequency line-line (f_G)	100 MHz	100 MHz
Approvals	UL, CSA, SIL, EAC	UL, CSA, EAC

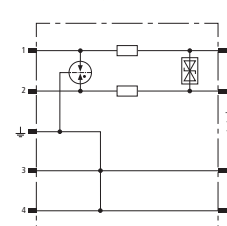



BLITZDUCTOR® XT Ex (i)

Pluggable SPDs –
DIN Rail mounted



Pluggable and universal multipole surge arrester for use in intrinsically safe systems with integrated LifeCheck monitoring function.

BLITZDUCTOR XT EX is a pluggable and universal four-pole DIN rail mounted surge arrester designed for the most stringent requirements on the availability of intrinsically safe measuring and control circuits and bus systems.

Regarding intrinsic safety, the arrester is considered unearthed and its self-inductance and self-capacitance are negligibly small. The low-impedance arrester design ensures a high impulse current discharge capacity (at least 10x) and a low voltage protection level.

LifeCheck allows quick and easy arrester testing, however, the protection modules may only be read by the hand-held DRC LC reader in non-explosive atmospheres.

Integrated in the protection modules, LifeCheck permanently monitors the operating state of the arrester. Like an early warning system, LifeCheck

- Surge arrester for intrinsically safe measuring circuits and bus systems
 - Maximum discharge capacity for two-pole, three-pole or four-pole interfaces
 - Low voltage protection level, capable of protecting terminal equipment
 - Wide range of approvals: ATEX, IECEx, CSA Hazloc
- Arrester consists of a protection module and a base part
 - Easy replacement of protection modules without force
 - All protection components are integrated in the protection module
 - Arrester with integrated LifeCheck for preventive arrester monitoring
- Functional and appealing design
 - DIN rail mounted arrester with integrated earthing
 - Minimum space requirements, two pairs over a width of 12 mm
 - Vibration and shock-tested for safe operation

detects imminent electrical or thermal overload of the protection components. The LifeCheck status can be read in a second by the hand-held DEHNrecord LC reader via non-contact RFID technology. Moreover, the date of the last test of the protection module can be displayed and saved. Stationary installed, a condition monitoring system allows condition-based maintenance of 10 BXT arresters.

The arrester provides protection against vibration effects and shock up to a 30-fold acceleration of gravity. The function-optimised arrester design allows quick and easy replacement of protection modules which house all relevant protection elements.

The **protection module** and **base part** must be ordered separately!



Two-part design comprising a universal base part and an application-specific protection module.



The module locking mechanism ensures that the module is vibration-proof and protected against polarity reversal.



All protection elements are integrated in the plug-in module and are monitored by means of LifeCheck.



Prewired surge arrester unit ITAK EXI BXT 24.

BLITZDUCTOR® XT Ex (i) – Base Part



BXT BAS EX – Base part without signal disconnection

- Universal base part for protection modules of the BLITZDUCTOR XT Ex (i) series
- No signal disconnection if the protection module is removed
- Connection of up to four lines



*) only in connection with an approved protection module

BXT BAS EX

BLITZDUCTOR XT base part for use as an extremely space-saving and universal four-pole **feed-through terminal** for intrinsically safe circuits for the insertion of the protection module, no signal disconnection if the protection module is removed. The snap-in mechanism at the supporting foot of the base part allows the device to be safely earthed via the DIN rail. Since no components of the protective circuit are situated in the base part, only the protection modules must be maintained.

Type	BXT BAS EX
Part No.	920 301
For mounting on	35 mm DINs rails acc. to EN 60715
Cross-sectional area, solid	0.08-4 mm ²
Cross-sectional area, flexible	0.08-2.5 mm ²
Tightening torque (terminals)	0.4 Nm
Earthing via	35 mm DIN rails acc. to EN 60715
Approvals	UL, CSA, EACEx, ATEX, IECEx, Inmetro *)

BLITZDUCTOR® XT Ex (i) – Protection Modules with LifeCheck®

BXT ML4 BD EX 24

Space-saving LifeCheck-equipped surge arrester module for protecting two pairs in intrinsically safe measuring circuits and bus systems.

Type	BXT ML4 BD EX 24
Part No.	920 381
SPD class	TYPE 2 Pt1
Max. continuous operating voltage (d.c.) (U_c)	33 V
Max. input current acc. to EN 60079-11 (I_i)	0.5 A
D1 Total lightning impulse current (10/350 μ s) (I_{imp})	4 kA
D1 Lightning impulse current (10/350 μ s) per line (I_{imp})	1 kA
C2 Total nominal discharge current (8/20 μ s) (I_n)	20 kA
Cut-off frequency line-line (f_G)	7.7 MHz
Approvals *)	CSA, EACEx, ATEX, IECEx, CSA & USA Hazloc, SIL, Inmetro

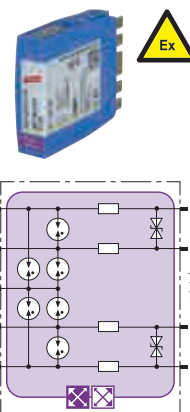

BXT ML2 BD S EX 24

Space-saving LifeCheck-equipped surge arrester module for protecting one pair in intrinsically safe measuring circuits and bus systems, direct or indirect shield earthing.

Type	BXT ML2 BD S EX 24
Part No.	920 280
SPD class	TYPE 2 Pt1
Max. continuous operating voltage (d.c.) (U_c)	33 V
Max. input current acc. to EN 60079-11 (I_i)	0.5 A
D1 Total lightning impulse current (10/350 μ s) (I_{imp})	4 kA
D1 Lightning impulse current (10/350 μ s) per line (I_{imp})	1 kA
C2 Total nominal discharge current (8/20 μ s) (I_n)	10 kA
Cut-off frequency line-line (f_G)	6 MHz
Approvals *)	EACEx, ATEX, IECEx, CSA & USA Hazloc, SIL, Inmetro

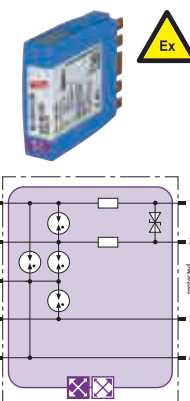

BXT ML4 BC EX 24

Space-saving LifeCheck-equipped surge arrester module for protecting up to four unearthed single lines sharing a common reference potential in intrinsically safe measuring circuits.

Type	BXT ML4 BC EX 24
Part No.	920 384
SPD class	TYPE 2 Pt1
Max. continuous operating voltage (d.c.) (U_c)	33 V
Max. input current acc. to EN 60079-11 (I_i)	0.5 A
D1 Total lightning impulse current (10/350 μ s) (I_{imp})	4 kA
D1 Lightning impulse current (10/350 μ s) per line (I_{imp})	1 kA
C2 Total nominal discharge current (8/20 μ s) (I_n)	20 kA
Cut-off frequency line-line (f_G)	6.4 MHz
Approvals *)	CSA, EACEx, ATEX, IECEx, CSA & USA Hazloc, SIL, Inmetro

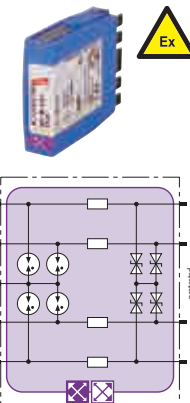

BXT ML2 BD HF EX 6

Space-saving LifeCheck-equipped surge arrester module for protecting intrinsically safe measuring circuits and RS485 bus systems.

Type	BXT ML2 BD HF EX 6
Part No.	920 538
SPD class	TYPE 2 Pt1
Max. continuous operating voltage (d.c.) (U_c)	6 V
Max. input current acc. to EN 60079-11 (I_i)	4.8 A
D1 Lightning impulse current (10/350 μ s) per line (I_{imp})	1 kA
C2 Total nominal discharge current (8/20 μ s) (I_n)	10 kA
Cut-off frequency line-line (f_G)	100 MHz
Approvals *)	EACEx, ATEX, IECEx, CSA & USA Hazloc, SIL, Inmetro

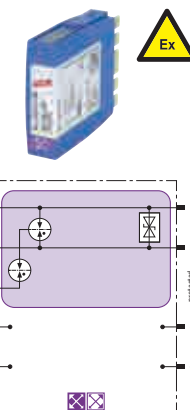

*) For more detailed information, please visit www.dehn-international.com.

Pluggable SPDs –
DIN Rail mounted

BLITZDUCTOR® XT Ex (i) – Protection Module



BXT M2 BD S EX 24

Space-saving surge arrester module for protecting one pair in intrinsically safe measuring circuits and bus systems, direct or indirect shield earthing.

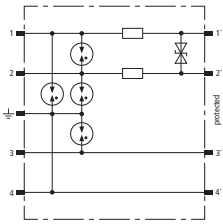

Type	BXT M2 BD S EX 24
Part No.	920 383
SPD class	TYPE 2 P1
Max. continuous operating voltage (d.c.) (U _c)	36 V
Max. input current acc. to EN 60079-11 (I _i)	0.5 A
D1 Total lightning impulse current (10/350 μs) (I _{imp})	4 kA
D1 Lightning impulse current (10/350 μs) per line (I _{imp})	1 kA
C2 Total nominal discharge current (8/20 μs) (I _n)	10 kA
Cut-off frequency line-line (f _c)	7.7 MHz
Approvals *)	ATEX, IECEx, CSA & USA Hazloc, SIL

*) For details see: www.dehn-international.com

Pluggable SPDs –
DIN Rail mounted

Accessories for BLITZDUCTOR® XT Ex (i)



Partition

Allows to position devices of the BXT family for non-intrinsically safe circuits directly next to intrinsically safe circuits (thread measure ≥ 50 mm). For DRC MCM XT and DRC SCM XT; 1 set = 2 pieces.

Type	TW DRC MCM EX
Part No.	910 697
For mounting on	35 mm DIN rails according to EN 60715

ITAK Ex (i)

ITAK EXI BXT

BXT ML4 BD EX 24 and BXT BAS EX completely mounted. ATEX, FISCO.

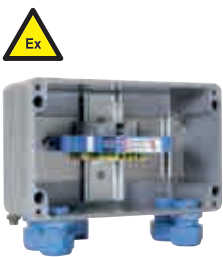

Type	ITAK EXI BXT 24
Part No.	989 408
SPD class	TYPE 2 P1
Max. continuous operating voltage (d.c.) (U _c)	33 V
Max. input current acc. EN 60079-11 (I _i)	0.5 A
Total nominal discharge current (8/20 μs) (I _n)	20 kA
Cut-off frequency line-line (f _c)	7.7 MHz
Degree of protection	IP 65
Approvals for installed BXT	CSA, EACEx, ATEX, IECEx, CSA & USA Hazloc, SIL

Accessories for BLITZDUCTOR® XT/XTU/SP/XT Ex (i)

Earthing Module

The plugged-in earthing module connects all lines connected to the BLITZDUCTOR SP/XT/XTU base part to the equipotential bonding. It directly earths unused cable cores that are already connected to the base part.

Type	BXT M4 E
Part No.	920 308
D1 Total lightning impulse current (10/350 µs) (I_{imp})	10 kA
Plugs into	base part



Test / Disconnection Module

The plugged-in test / disconnection module interrupts the cable run of the lines connected to the BLITZDUCTOR SP/XT/XTU base part and leads them to a test socket at the front of the module. This allows to carry out measurements in the installation without removing the lines from the base part.

Type	BXT M4 T
Part No.	920 309
Max. continuous operating voltage (d.c.) (U_c)	180 V
Nominal current at 80 °C (I_n)	1.0 A
Volume resistance	0.1 ohms
Plugs into	base part
Test sockets	gold-plated, 1 mm
Accessories	2 measuring lines (1 m), protective bag



Labelling System BA1-BA15

2x 165 adhesive labels for labelling DRC MCM XT monitoring devices with the bus address (BA1 to BA15) and BXT modules with consecutive numbers (1.1-1.10 to 15.1-15.10).

Type	BS BA1 BA15 BXT
Part No.	920 398
Dimensions (W x H)	13 x 7 mm



EMC Spring Terminals

Two spring terminals for the protected and unprotected side of a BLITZDUCTOR BSP / XT / XTU arrester for permanent low-impedance shield contact with a shielded signal line. Insulating cap for indirect shield earthing (BXT only), cable ties and insulating strips included. Suitable for BXT(U) ML2 ...S ... / BSP M2 ... types (direct shield earthing only).

Type	SAK BXT LR
Part No.	920 395
D1 Lightning impulse current (10/350 µs)	5 kA
Plugs into	terminal BXT BAS / BSP BAS 4
Accessories	insulating caps, cable ties, insulating strips



Accessories for BLITZDUCTOR® XT/XTU

DRC MCM XT

DIN rail mounted device with integrated LifeCheck sensor for condition monitoring of max. 10 LifeCheck-equipped BXT/BXTU arresters. An RS 485 interface allows to interconnect up to 15 DRC MCM XT.

Type	DRC MCM XT
Part No.	910 695
Colour	grey



DRC SCM XT

DIN rail mounted device with integrated LifeCheck sensor for condition monitoring of max. 10 LifeCheck-equipped BXT/BXTU arresters.

Type	DRC SCM XT
Part No.	910 696
Colour	grey





DRC LC M3+

Portable device with LifeCheck sensor for flexible use. Fast and easy testing of LifeCheck-equipped arresters. Documentation via PC database.

Type	DRC LC M3+
Part No.	910 653
Dimensions of storage case	340 x 275 x 83 mm



DRC LC M1+

Portable device with LifeCheck sensor for flexible use. Fast and easy testing of LifeCheck-equipped arresters.

Type	DRC LC M1+
Part No.	910 655
Dimensions of storage case	275 x 230 x 83 mm



LifeCheck Sensor for DRC BXT

Snap-on LifeCheck sensor and test module for use as spare part / extension for portable LifeCheck test devices.

Type	LCS DRC BXT
Part No.	910 652
For testing	BLITZDUCTOR XT ML

DIN Rail mounted Power Supply Unit

High-performance DIN rail mounted power supply unit with single-phase wide-range input can be connected to different supply systems. The operating state indicator on the front panel indicates whether the output voltage is present. Up to 10 DRC MCM XT or DRC SCM XT (single application) or up to 15 DRC MCM XT (multiple application) monitoring devices can be connected to a single power supply unit.



Type	PSU DC24 30W
Part No.	910 499
Input voltage range	AC 85-264 V; DC 120-373 V
Frequency	44-66 Hz; 0 Hz
Input current (I_e)	0.7 A at AC 110 V / 0.5 A at AC 230 V
Output nominal voltage (U_a)	DC 24 V (SELV)
Output current (I_a)	1.3 A at DC 24 V, max. 0.9 A at any installation position
Recommended backup fuse	circuit breaker 10 A, 16 A, characteristic B, C
Standards / regulations	EN 60950, EN 61204-3, UL 60950, UL 508, GL







USB Interface Converter of Type USB-NANO-485

USB-Nano-485 converts between USB and RS485 signals and is specifically designed for two-wire RS-485 buses. LEDs indicate the operating state (yellow), Rx (green) and Tx (red). Due to its compact dimensions, USB-Nano-485 is ideally suited for use with notebooks, however, stationary use is also possible.



Type	USB NANO 485
Part No.	910 486
Version	with LED indication







BLITZDUCTOR® XT/XTU – List of Approvals (as of September 2018)

Part No.	Type	ATEX 	IECEX 	CSA-Hazloc 	SIL (up to SIL3)	UL 	CSA 	EAC 	EAC 
920 211	BXT ML2 B 180	●(1)	●(2)	●(5)	●		●	●	
920 220	BXT ML2 BE S 5	●(1)	●(2)	●(5)	●		●	●	
920 222	BXT ML2 BE S 12	●(1)	●(2)	●(5)	●		●	●	
920 224	BXT ML2 BE S 24	●(1)	●(2)	●(5)	●		●	●	
920 225	BXT ML2 BE S 48	●(1)	●(2)	●(5)	●	●	●	●	
920 226	BXT ML2 BE S 36					●		●	
920 240	BXT ML2 BD S 5	●(1)	●(2)	●(5)	●		●	●	
920 242	BXT ML2 BD S 12	●(1)	●(2)	●(5)	●		●	●	
920 243	BXT ML2 BD DL S 15	●(1)	●(2)	●(5)	●			●	
920 244	BXT ML2 BD S 24	●(1)	●(2)	●(5)	●		●	●	
920 245	BXT ML2 BD S 48	●(1)	●(2)	●(5)	●		●	●	
920 247	BXT ML2 BD 180	●(1)	●(2)	●(5)	●		●	●	
920 270	BXT ML2 BE HFS 5	●(1)	●(2)	●(5)	●	●	●	●	
920 271	BXT ML2 BD HFS 5	●(1)	●(2)	●(5)	●	●	●	●	
920 288	BXT ML2 MY E 110							●	
920 289	BXT ML2 MY 250							●	
920 296	BXT ML BD HC5A 24				●			●	
920 310	BXT ML4 B 180	●(1)	●(2)	●(5)	●		●	●	
920 314	BXT ML4 BPD 24				●			●	
920 320	BXT ML4 BE 5	●(1)	●(2)	●(5)	●	●	●	●	
920 322	BXT ML4 BE 12	●(1)	●(2)	●(5)	●	●	●	●	
920 324	BXT ML4 BE 24	●(1)	●(2)	●(5)	●	●	●	●	
920 325	BXT ML4 BE 48	●(1)	●(2)	●(5)	●	●	●	●	
920 326	BXT ML4 BE 60	●(1)	●(2)	●(5)	●	●	●	●	
920 327	BXT ML4 BE 180	●(1)	●(2)	●(5)	●	●	●	●	
920 336	BXT ML4 BE 36	●(1)	●(2)	●(5)	●	●		●	
920 340	BXT ML4 BD 5	●(1)	●(2)	●(5)	●	●	●	●	
920 342	BXT ML4 BD 12	●(1)	●(2)	●(5)	●	●	●	●	
920 344	BXT ML4 BD 24	●(1)	●(2)	●(5)	●	●	●	●	
920 345	BXT ML4 BD 48	●(1)	●(2)	●(5)	●	●	●	●	
920 346	BXT ML4 BD 60	●(1)	●(2)	●(5)	●	●	●	●	
920 347	BXT ML4 BD 180	●(1)	●(2)	●(5)	●	●	●	●	
920 350	BXT ML4 BC 5	●(1)	●(2)	●(5)	●		●	●	
920 354	BXT ML4 BC 24	●(1)	●(2)	●(5)	●		●	●	
920 362	BXT ML4 BE C 12	●(1)	●(2)	●(5)	●			●	
920 364	BXT ML4 BE C 24	●(1)	●(2)	●(5)	●		●	●	
920 370	BXT ML4 BE HF 5	●(1)	●(2)	●(5)	●	●	●	●	
920 371	BXT ML4 BD HF 5	●(1)	●(2)	●(5)	●	●	●	●	
920 375	BXT ML4 BD HF 24	●(1)	●(2)	●(5)	●	●	●	●	
920 388	BXT ML4 MY 110							●	
920 389	BXT ML4 MY 250				●			●	
920 280	BXT ML2 BD S EX 24	●(3)	●(4)	●(6)					●(11)
920 381	BXT ML4 BD EX 24	●(3)	●(4)	●(6)	●		●		●(10)
920 384	BXT ML4 BC EX 24	●(3)	●(4)	●(6)	●		●		●(10)
920 538	BXT ML2 BD HF EX 6	●(3)	●(4)	●(6)	●				●(11)
920 383	BXT M2 BD S EX 24	●(9)	●(8)	●(7)					
920 249	BXTU ML2 BD S 0-180				●	●	●	●	
920 349	BXTU ML4 BD 0-180				●	●	●	●	

For more detailed information on approvals and SIL, please visit www.dehn-international.com

BLITZDUCTOR® SP – List of Approvals (as of September 2018)

Pluggable SPDs –
DIN Rail mounted

Part No.	Type	ATEX 	IECEX 	CSA-Hazloc 	SIL (up to SIL3)	UL 	CSA 	EAC 
926 220	BSP M2 BE 5				•	•	•	•
926 222	BSP M2 BE 12				•	•	•	•
926 224	BSP M2 BE 24				•	•	•	•
926 225	BSP M2 BE 48				•	•	•	•
926 226	BSP M2 BE 60				•	•	•	•
926 227	BSP M2 BE 180				•	•	•	•
926 240	BSP M2 BD 5				•	•	•	•
926 242	BSP M2 BD 12				•	•	•	•
926 244	BSP M2 BD 24				•	•	•	•
926 245	BSP M2 BD 48				•	•	•	•
926 246	BSP M2 BD 60				•	•	•	•
926 247	BSP M2 BD 180				•	•	•	•
926 270	BSP M2 BE HF 5				•	•	•	•
926 271	BSP M2 BD HF 5				•	•	•	•
926 275	BSP M2 BD HF 24					•	•	•
926 320	BSP M4 BE 5				•	•	•	•
926 322	BSP M4 BE 12				•	•	•	•
926 324	BSP M4 BE 24				•	•	•	•
926 325	BSP M4 BE 48				•	•	•	•
926 326	BSP M4 BE 60				•	•	•	•
926 327	BSP M4 BE 180				•	•	•	•
926 340	BSP M4 BD 5				•	•	•	•
926 342	BSP M4 BD 12				•	•	•	•
926 344	BSP M4 BD 24				•	•	•	•
926 345	BSP M4 BD 48				•	•	•	•
926 346	BSP M4 BD 60				•	•	•	•
926 347	BSP M4 BD 180				•	•	•	•
926 370	BSP M4 BE HF 5				•	•	•	•
926 371	BSP M4 BD HF 5				•	•	•	•
926 375	BSP M4 BD HF 24					•	•	•

(1)	DEKRA 11ATEX0089 X: II 3 G Ex nA IIC T4 Gc
(2)	DEK 11.0032X: Ex nA IIC T4 Gc
(3)	KEMA 06ATEX0274 X: II 2(1) G Ex ia [ia Ga] IIC T4 ... T6 Gb KEMA 06ATEX0274 X: II 2 G Ex ib IIC T4 ... T6 Gb
(4)	DEK 11.0078 X: Ex ia [ia Ga] IIC T4 ... T6 Gb DEK 11.0078 X: Ex ib IIC T4, T5, T6 Gb
(5)	CSA 2516389: Class I Div. 2 GP A, B, C, D T4 CSA 2516389: Class I Zone 2, AEx nA IIC T4
(6)	CSA 12.70000011: IS, Class I, Zone 1, AEx ia [ia] IIC T4 ... T6 CSA 12.70000011: IS, Class I, Div 1, Group A, B, C, D, T4 ... T6 CSA 12.70000011: Ex ia [ia] IIC T4...T6 Gb

(7)	CSA 2392869: IS, Class I, Div. 1, GP A, B, C, D T4 ... T6 CSA 2392869: IS, Class I, Zone 1, AEx ia IIC T4 ... T6 CSA 2392869: Ex ia IIC T4...T6 CSA 2392869: Class I Div. 2, GP A,B,C,D T4 ... T6 CSA 2392869: Class I, Zone 2, AEx nA IIC T4 ... T6 CSA 2392869: Ex nA IIC T4...T6
(8)	KEM 09.0077X: Ex ia [ia Ga] IIC T4 ... T6 Gb KEM 09.0077X: Ex ic IIC T4...T6 Gc KEM 09.0077X: Ex nA IIC T4...T6 Gc
(9)	KEMA 09ATEX0177 X: II 3 G Ex ic IIC T4 ... T6 Gc KEMA 09ATEX0177 X: II 3 G Ex nA IIC T4 ... T6 Gc KEMA 09ATEX0178 X: II 2(1) G Ex ia [ia Ga] IIC T4 ... T6 Gb
(10)	EAC TC RU C-DE.GB06.B00505 0ExIICT4/T5/T6
(11)	EAC TC RU C-DE.GB06.B00505 1ExIICT4/T5/T6

For more detailed information on approvals and SIL, please visit www.dehn-international.com



DEHNconnect SD2

- Terminal block with integrated surge protection
 - For protecting measuring and control circuits and bus systems
 - Maximum impulse current carrying capability I_{max} up to 20 kA (8/20 μ s)
 - Low voltage protection level, capable of protecting terminal equipment
 - No back up fuse up to 500 mA
- Modular disconnection function
 - Disconnection module for disconnecting the signal circuit for maintenance work
 - Module fixing and mechanical ejector
 - Module in “parked” position after disconnection
- Space-saving and function-optimised design
 - Terminal block with integrated surge protection (width of 6 mm)
 - Fast conductor connection without tools thanks to direct plug-in technology
 - Can be used with jumper bar (accessory)

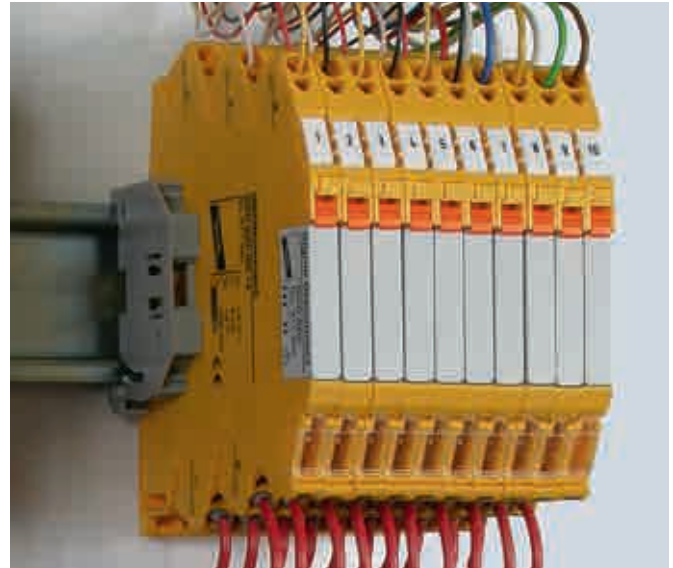

Application example: DEHNconnect for protecting the I/O of PLC interfaces.

The surge arresters of the DEHNconnect SD2 series are designed as space-saving terminal blocks with a width of 6 mm. These terminal blocks with integrated surge protection have a modular disconnection function that allows them to interrupt the signal circuit for maintenance work. An integrated module ejector disconnects the signal circuit from the terminal equipment. The disconnection module does not have to be removed, but remains in a “parked” position in the module slot.

Different types of arresters are available and protect two single lines sharing a common reference potential (unbalanced interfaces) or an unearthed pair (balanced interface). Arresters with a high cut-off frequency (HF) can be used for balanced bus interfaces with high data rates (e.g. Profibus, RS485).

Conductors are connected via a vibration-proof spring-loaded connection system. Stripped solid conductors and flexible conductors with wire end ferrule can be easily and quickly inserted into the relevant conductor terminal without the use of tools. For rewiring, the conductor is removed from the clamping point and clamped into a new conductor terminal.

To reduce wiring, jumper bars can be inserted at the protected side of the surge arrester, thus quickly connecting signal circuits.

The arresters are ideally suited for use in industrial environments at information technology signal interfaces of automation, measuring and control as well as bus systems.



Disconnection module with ejector – for disconnecting the signal circuits.



Marking of the protected side – minimises wiring errors.



Terminals with direct-plug-in technology – fast and vibration-proof connection.

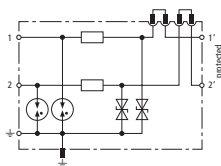

Slots for jumper bars – for quickly connecting signal circuits.

DCO SD2 ME

Energy-coordinated surge arrester with disconnection function for protecting two single lines sharing a common reference potential as well as unbalanced interfaces.

Type DCO SD2 ...	ME 12	ME 24	ME 48
Part No.	917 920	917 921	917 922
SPD class	TYPE 2 P1	TYPE 2 P1	TYPE 2 P1
Max. continuous operating voltage (d.c.) (U_c)	14 V	33 V	55 V
Nominal current at 80 °C (I_n)	0.5 A	0.5 A	0.5 A
D1 Lightning impulse current (10/350 μ s) per line (I_{imp})	1 kA	1 kA	1 kA
C2 Total nominal discharge current (8/20 μ s) (I_n)	10 kA	10 kA	10 kA
Cut-off frequency line-PG (f_G)	2.5 MHz	6 MHz	7.5 MHz
Approvals	UL, CSA, SIL, EAC, ATEX, IECEx	UL, CSA, SIL, EAC, ATEX, IECEx	UL, CSA, SIL, EAC, ATEX, IECEx

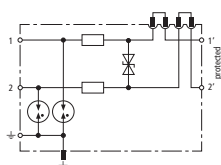
DCO SD2 MD

Energy-coordinated surge arrester with disconnection function for protecting one unearthed pair as well as balanced interfaces.

Type DCO SD2 ...	MD 12	MD 24	MD 48
Part No.	917 940	917 941	917 942
SPD class	TYPE 2 P1	TYPE 2 P1	TYPE 2 P1
Max. continuous operating voltage (d.c.) (U_c)	14 V	33 V	55 V
Nominal current at 80 °C (I_n)	0.5 A	0.5 A	0.5 A
D1 Lightning impulse current (10/350 μ s) per line (I_{imp})	1 kA	1 kA	1 kA
C2 Total nominal discharge current (8/20 μ s) (I_n)	10 kA	10 kA	10 kA
Cut-off frequency line-PG (f_G)	2.5 MHz	6 MHz	8 MHz
Approvals	UL, CSA, SIL, EAC, ATEX, IECEx	UL, CSA, SIL, EAC, ATEX, IECEx	UL, CSA, SIL, EAC, ATEX, IECEx

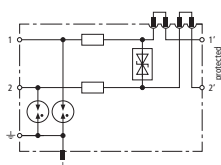
DCO SD2 MD HF

Energy-coordinated surge arrester with disconnection function for protecting balanced interfaces with extra-low voltages. Also suitable for high transmission rates.

Type DCO SD2 ...	MD HF 5
Part No.	917 970
SPD class	TYPE 2 P1
Max. continuous operating voltage (d.c.) (U_c)	8.5 V
Nominal current at 80 °C (I_n)	0.5 A
D1 Lightning impulse current (10/350 μ s) per line (I_{imp})	1 kA
C2 Total nominal discharge current (8/20 μ s) (I_n)	10 kA
Cut-off frequency line-line (f_G)	100 MHz
Approvals	UL, CSA, SIL, EAC, ATEX, IECEx

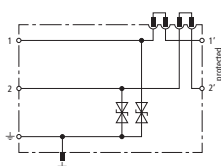
DCO SD2 E

Finely-limiting surge protective device with disconnection function for two single lines sharing a common reference potential and unbalanced interfaces.

Type DCO SD2 ...	E 12	E 24	E 48
Part No.	917 987	917 988	917 989
SPD class	TYPE 3 P1	TYPE 3 P1	TYPE 4 P1
Max. continuous operating voltage (d.c.) (U_c)	13 V	28 V	58 V
Nominal current at 60 °C (I_n)	10 A	10 A	10 A
C1 Total nominal discharge current (8/20 μ s) (I_n)	0.8 kA	0.6 kA	0.3 kA
Cut-off frequency line-PG (f_G)	2.3 MHz	5.5 MHz	8.7 MHz
Approvals	UL, CSA, SIL, EAC	UL, CSA, SIL, EAC	UL, CSA, SIL, EAC



DEHNconnect SD2 Ex (i)

- Terminal block with integrated surge protection
 - For protecting intrinsically safe measuring and control circuits and bus systems (Ex (i))
 - Maximum impulse current carrying capability I_{max} up to 20 kA (8/20 μ s)
 - Low voltage protection level, capable of protecting terminal equipment
 - Approvals: ATEX, IECEx
- Modular disconnection function
 - Disconnection module for disconnecting the signal circuit for maintenance work
 - Module fixing and mechanical ejector
 - Module in “parked” position after disconnection
- Space-saving and function-optimised design
 - Terminal block with integrated surge protection (width of 6 mm)
 - Fast conductor connection without tools thanks to direct plug-in technology
 - Can be used with jumper bar (accessory)



Arrester group for protecting intrinsically safe measuring circuits

Terminal Block SPDs
DIN Rail mounted

The surge arresters of the DEHNconnect SD2 series are designed as space-saving terminal blocks with a width of 6 mm. These terminal blocks with integrated surge protection have a modular disconnection function that allows them to disconnect the signal circuit for maintenance work. An integrated module ejector disconnects the signal circuit from the terminal equipment. The disconnection module does not have to be removed, but remains in a “parked” position in the module slot.

DEHNconnect SD2 Ex (i) is designed for intrinsically safe measuring and control circuits and bus systems and protects one unearthed pair (balanced interface).

Conductors are connected via a vibration-proof spring-loaded connection system. Stripped solid conductors and flexible conductors with wire end ferrule can be easily and quickly inserted into the relevant conductor terminal without the use of tools. For rewiring, the conductor is removed from the clamping point and clamped into a new conductor terminal.

To reduce wiring, jumper bars can be inserted at the protected side of the surge arrester, thus quickly connecting signal circuits.

The arresters are ideally suited for use in the process industry to protect Ex (i) measuring circuits and interfaces for bus communication (e.g. Fieldbus Foundation or Profibus PA).



Disconnection module with ejector – for disconnecting the signal circuits.



Marking of the protected side – minimises wiring errors.



Terminals with direct plug-in technology – fast and vibration-proof connection without tools.



Slots for jumper bars – for quickly connecting signal circuits.

DCO SD2 MD EX

Surge arrester with energy-coordinated low-capacitance protective circuit and disconnection module for disconnecting signal circuits. For protecting one pair in intrinsically safe measuring circuits and bus systems, meets FISCO requirements. Self-capacitance and self-inductance negligibly small. Insulation strength > 500 V to earth.

Type	DCO SD2 MD EX 24
Part No.	917 960
SPD class	TYPE 2 P1
Max. continuous operating voltage (d.c.) (U_c)	33 V
Max. input current according to EN 60079-11 (I_i)	0.5 A
D1 Lightning impulse current (10/350 μ s) per line (I_{imp})	1 kA
C2 Total nominal discharge current (8/20 μ s) (I_n)	10 kA
Cut-off frequency line-line (f_G)	5.8 MHz
Approvals	UL, CSA, EACEx, ATEX, IECEx, SIL

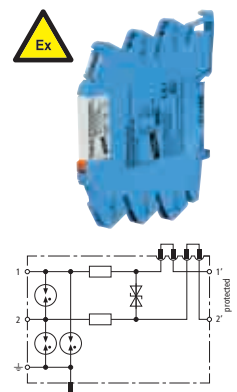

Accessories for DEHNconnect SD2

Signal Disconnect Disconnection Module (Spare Part)

Disconnection module (spare part) to be plugged into DCO SD2 for disconnecting the signal in the system circuit.



Type	DCO SD2
Part No.	917 900
Width	6 mm

Jumper Bar

Multipole jumper bar for DCO SD2 terminal blocks with integrated surge protection.



Type	KB 10 DCO RK
Part No.	919 880
Poles	10

Quick Labelling System, horizontal Imprint

Plate with 2x plate numbers from 1 to 50 for DCO SD2, horizontal imprint.



Type	LS 1 50 H DCO
Part No.	917 977
Material	plastic

List of Approvals (as of September 2018)

Part No.	Type	ATEX 	IECEX 	SIL (up to SIL3)	UL 	CSA 	EAC 	EAC
917 920	DCO SD2 ME 12	•	•	•	•	•	•	
917 921	DCO SD2 ME 24	•	•	•	•	•	•	
917 922	DCO SD2 ME 48	•	•	•	•	•	•	
917 940	DCO SD2 MD 12	•	•	•	•	•	•	
917 941	DCO SD2 MD 24	•	•	•	•	•	•	
917 942	DCO SD2 MD 48	•	•	•	•	•	•	
917 970	DCO SD2 MD HF 5	•	•	•	•	•	•	
917 987	DCO SD2 E 12			•	•	•	•	
917 988	DCO SD2 E 24			•	•	•	•	
917 989	DCO SD2 E 48			•	•	•	•	
917 960	DCO SD2 MD EX 24	•(3)	•(4)	•	•	•		•(5)

(1)	KEMA 09ATEX0124 X: II 2(1)G Ex ia IIC T4 ... T6 Gb
(2)	DEK 13.0033X: Ex ia [ia Ga] IIC T4 ... T6 Gb
(3)	DEKRA 12ATEX0261 X: II 2(1)G Ex ia [ia Ga] IIC T4 ... T6 Gb
(4)	DEK 12.0076X: Ex ia [ia Ga] IIC T4 ... T6 Gb
(5)	EAC TC TU C-DE.GB06.B.00505 0ExiaIIC T4/T5/T6
(6)	DEKRA 17ATEX0046X: II 3 G Ex ec IIC T4...T6 Gc
(7)	IECEX DEK 17.0023X: Ex ec IIC T4...T6 Gc

For more detailed information on approvals and SIL, please visit www.dehn-international.com



DEHNvario

Variable arrester series

- Compact terminals ensure easy and fast installation
- Direct plug-in technology allows connection without tools
- Fast arrester replacement by simply releasing and removing the terminal unit
- Earthing / equipotential bonding via DIN rail
- Customised and application-specific surge protection



Space-saving and application-optimised 3in1 DEHNvario arrester for analogue camera systems.

DEHNvario product line – Surge or combined arresters in a compact DIN rail mounted enclosure.

Innovative enclosure concept

The innovative enclosure design provides maximum functionality on minimum space. In addition to the standard catalogue products, the enclosure concept offers flexibility in terms of space and different connection systems to **implement customised and application-specific solutions** (upon request). Supplemented by solution-oriented surge protection, the integrated customer function can be protected from possible interference by lightning strikes and surges.

Terminals with direct plug-in technology

The different types feature terminals for conductor connection with direct plug-in technology. This allows easy connection of conductors without tools. The spring-loaded terminals apply a defined pressure on the conductors which automatically equalises any deformation of

connected conductors and prevents self-loosening of the wires. The plugged-in conductors can be easily released at the push of a button and individually removed from the relevant terminal.

The terminal unit is snapped into the enclosure and is thus vibration-proof in all environmental conditions. Easy and fast arrester replacement is ensured by removing the terminal units from the enclosure using an unlocking tool or screw driver. Thus there is no need to disconnect the cores individually. Thanks to the integrated test openings in the terminal units, the signal circuit can be tested efficiently even when wired. The signal lines can be contacted by means of a test pin (max. diameter of 1 mm) (device must be installed).

Safe and easy earthing

The lightning and impulse current carrying earth contact allows the arresters to be easily connected to the equipotential bonding via the DIN rail without requiring an equipotential bonding conductor.

Compact SPDs –
DIN Rail mounted



Direct plug-in technology ensures easy conductor connection without tools.



Fast arrester replacement by simply removing the terminal unit.



Integrated test openings for testing the signal circuit by means of test pins.



Lightning and impulse current carrying earth contact.



Indication can be optionally integrated.



Sample solution: Compact 3in1 arrester for protecting 3 interfaces in a single device.

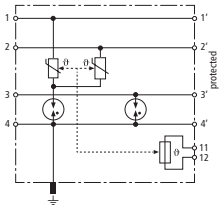

DVR 2 BY S 150 FM

Compact combined arrester for protecting electroacoustic systems (e.g. voice alarm systems, loudspeaker systems). Protection of one galvanically isolated pair; direct or indirect shield earthing. Direct plug-in technology allows fast conductor connection without tools. Easy replacement of the arrester is ensured by the integrated terminal units which can be released and then removed from the enclosure. Integrated remote signalling contact (break contact).

Type DVR ...	2 BY S 150 FM
Part No.	928 430
SPD class	TYPE 1P2
Max. continuous operating voltage (d.c.) (U_c)	150 V
Nominal current at 70 °C (I_L)	10 A
Nominal current at 80 °C (I_L)	7 A
D1 Lightning impulse current (10/350 μ s) per line (I_{imp})	2.5 kA
C2 Total nominal discharge current (8/20 μ s) (I_n)	22.5 kA
Cut-off frequency line-line (f_G)	1.4 MHz
Approvals	EAC

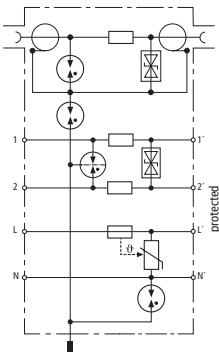

DVR BNC RS485 230

Compact 3in1 surge arrester for protecting analogue camera systems. Protection of the video signal (BNC connection), a data signal (RS485) and a voltage supply (230 V a.c.). Direct plug-in technology allows fast conductor connection without tools. Easy replacement of the arrester is ensured by the integrated terminal units which can be released and then removed from the enclosure. Integrated overload indication (230 V).

Type DVR ...	BNC RS485 230
Part No.	928 440
Video (BNC)	
SPD class	TYPE 2P2
Max. continuous operating voltage (d.c.) (U_c)	6.4 V
Nominal current (I_L)	100 mA
C2 Nominal discharge current (8/20 μ s) shield-PG (I_n)	10 kA
Insertion loss at 300 MHz (75 ohms)	≤ 3.0 dB
Connection (input / output)	BNC socket / BNC socket
Data (RS485)	
SPD class	TYPE 2P1
Max. continuous operating voltage (d.c.) (U_c)	8 V
Nominal current (I_L)	0.5 A
C2 Total nominal discharge current (8/20 μ s) (I_n)	10 kA
Cut-off frequency line-line (f_G)	100 MHz
Voltage supply (230 V)	
SPD class	type 2 / class II
Max. continuous operating voltage (a.c.) [L-N] (U_c)	255 V (50 / 60 Hz)
Max. continuous operating voltage (a.c.) [N-PE] (U_c)	255 V (50 / 60 Hz)
Nominal current (I_L)	10 A
Nominal discharge current (8/20 μ s) (I_n)	5 kA
Max. discharge current (8/20 μ s) (I_{max})	10 kA
Voltage protection level [L-N] (U_P)	≤ 1.5 kV
Voltage protection level [N-PE] (U_P)	≤ 1.5 kV
General parameters	
Approvals	EAC

Compact SPDs –
DIN Rail mounted



BLITZDUCTOR® VT

- Cost-effective protection of multi-core signal lines
- Interface-specific versions, e.g. TTY, RS485, telecommunication systems
- Versions for d.c. power supply systems

BLITZDUCTOR VT is a family of compact DIN rail mounted arresters and consists of different types of enclosures with different connection methods. Both devices for protecting four-wire signal interfaces with screw connections, but also devices for protecting terminal equipment of telecommunication systems as well as telephone systems with RJ connection are for example available. All types can be mounted on DIN rails and are earthed via a screw terminal.

Different types of BLITZDUCTOR VT arresters are available depending on the application.



Compact DIN rail mounted surge protective device with screw terminals for multi-core lines.

Compact SPDs –
DIN Rail mounted



BVT enclosure type with a width of 1.5 modules and screw terminals:
BVT AVD/ALD: Two protected lines for d.c. power supply systems
BVT (M)TTY: Four protected signal cores



BVT enclosure type with a width of 3 modules and screw terminals:
BVT RS485 specifically designed for protecting RS485 / RS422 interfaces.



BVT enclosure type with a width of 1.5 modules and RJ connection:
BVT TC1 and BVT ISDN for protecting telecommunication interfaces.



Separate earth connection on the unprotected side of the device. The second slot of the double terminal is intended for connecting the terminal equipment to the equipotential bonding.

BVT TTY

Energy-coordinated protection for four-wire optocoupler interfaces with additional decoupling resistor at the output.

Type BVT ...	TTY 24
Part No.	918 400
SPD class	
Max. continuous operating voltage (d.c.) (U_c)	26.8 V
Nominal current (I_n)	0.1 A
D1 Lightning impulse current (10/350 μ s) per line (I_{imp})	0.8 kA
C2 Total nominal discharge current (8/20 μ s) (I_n)	10 kA
Series resistance per line	17.2 ohms per pair
Cut-off frequency line-line (f_c)	8 MHz
Approvals	CSA, EAC

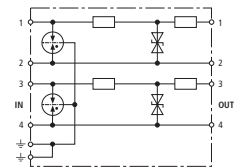

BVT MTTY

Energy-coordinated surge arrester, no leakage currents to earth, for two unearthed pairs.

Type BVT ...	MTTY 24
Part No.	918 407
SPD class	
Max. continuous operating voltage (d.c.) (U_c)	26.8 V
Nominal current (I_n)	0.1 A
D1 Lightning impulse current (10/350 μ s) per line (I_{imp})	0.8 kA
C2 Total nominal discharge current (8/20 μ s) (I_n)	20 kA
Series resistance per line	2.2 ohms per pair
Cut-off frequency line-line (f_c)	10 MHz
Approvals	EAC

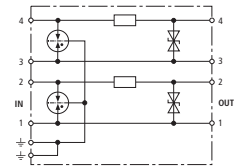

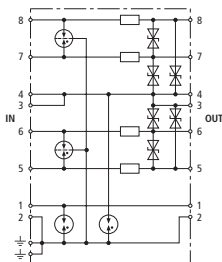

BVT RS485

Protection for balanced four-wire RS485/422 interfaces, direct or indirect shield earthing, connection of a signal ground.

Type BVT ...	RS485 5
Part No.	918 401
SPD class	TYPE 2 P1
Max. continuous operating voltage (d.c.) (U_c)	6 V
Nominal current (I_L)	0.5 A
D1 Lightning impulse current (10/350 μ s) per line (I_{imp})	0.8 kA
C2 Total nominal discharge current (8/20 μ s) (I_n)	10 kA
Series resistance per line	1.8 ohms
Cut-off frequency line-line (f_G)	1.7 MHz
Approvals	CSA, EAC

Compact SPDs –
DIN Rail mounted

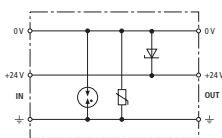

BVT AVD

Surge arrester with improved voltage protection levels for EMC protection of electronic components with d.c. voltage supply. Ideally suited for Siemens PLCs.

Type BVT ...	AVD 24
Part No.	918 422
SPD class	TYPE 3 P1
Max. continuous operating voltage (d.c.) (U_c)	35 V
Nominal current at 80 °C (I_L)	10 A
C2 Total nominal discharge current (8/20 μ s) (I_n)	2 kA
Approvals	EAC

BVT ALD

Energy-coordinated, DIN rail mounted combined lightning current and surge arrester for protecting unearthed d.c. power supply systems.

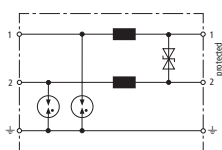

Type BVT ...	ALD 36	ALD 60
Part No.	918 408	918 409
SPD class	TYPE 1 P1	TYPE 1 P1
Max. continuous operating voltage (d.c.) (U_c)	45 V	65 V
Nominal current at 80 °C (I_L)	4 A	4 A
Nominal current at 45 °C (I_L)	7 A	7 A
Backup fuse if	—	$U_N \geq 45$ V and $I_L \geq 1$ A
D1 Lightning impulse current (10/350 μ s) per line (I_{imp})	2.5 kA	2.5 kA
D1 Total lightning impulse current (10/350 μ s) (I_{imp})	5 kA	5 kA
C2 Total nominal discharge current (8/20 μ s) (I_n)	20 kA	20 kA
Series resistance per line	22 μ H	22 μ H
Approvals	UL, EAC	UL, EAC

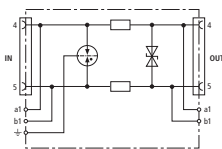

BVT TC

Energy-coordinated leakage-current-free surge arrester for a/b lines, ISDN U_{k0} or ADSL with RJ45 connections and additional screw terminals. Compatible with RJ11/12.

Type BVT ...	TC 1
Part No.	918 411
SPD class	TYPE 2 P2
Max. continuous operating voltage (d.c.) (U_c)	170 V
Nominal current (I_L)	0.2 A
D1 Lightning impulse current (10/350 μ s) per line (I_{imp})	1 kA
C2 Total nominal discharge current (8/20 μ s) (I_n)	5 kA
Series resistance per line	4.7 ohms
Cut-off frequency line-line (f_G)	17 MHz
Approvals	EAC



BLITZDUCTOR® VT KKS

Combined lightning current and surge arrester for cathodic protection systems

- Extremely efficient thanks to high discharge capacity
- Easy maintenance due to remote signalling contact
- Resistant to permanent interference voltages up to 65 V a.c.

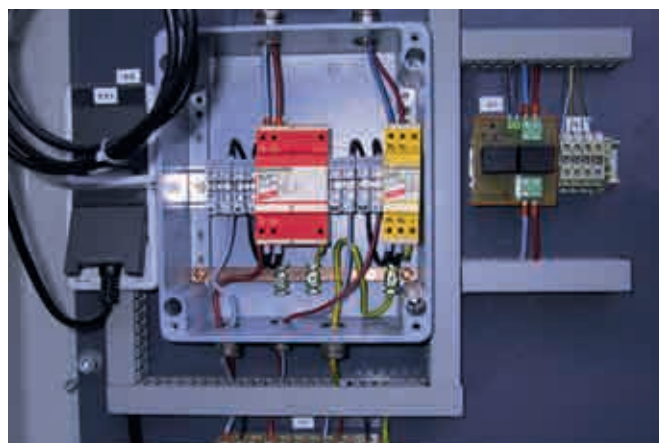

Arrester for protecting active cathodic protection systems. Integrated floating remote signalling contact (break contact) monitors the function of the arrester.

The protective circuit and voltage measuring circuit are protected against surges caused by atmospheric discharges (lightning strikes) or switching operations (in power supply lines).

The devices are designed for permanent interference voltages up to 65 V a.c. between pipelines and earth. If this value is exceeded, the relevant regulations concerning protection against electric shock have to be observed and further measures have to be taken.

The devices may be overloaded by overcurrents as a result of mains faults (short-circuits or earth faults). For this reason, they should be installed in a separate metal enclosure. The integrated remote signalling contact indicates thermal overload of the discharge paths.

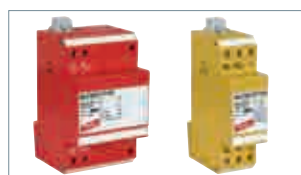

Different arresters for the protective circuit (red) and voltage measuring circuit (yellow).



The arresters for cathodic corrosion protection are equipped with a remote signalling contact.

Compact SPDs – DIN Rail mounted

BVT KKS ALD

Combined arrester for protecting anode circuits up to 12 A. With floating remote signalling contact (break contact). Installation into steel-sheet enclosure recommended.

Type BVT KKS ...	ALD 75
Part No.	918 420
SPD class	TYPE 1 P1
Max. continuous operating voltage (d.c.) (U_c)	75 V
Nominal current (I_n)	12 A
D1 Total lightning impulse current (10/350 μ s) (I_{imp})	7 kA
C2 Total nominal discharge current (8/20 μ s) (I_n)	40 kA
Series resistance per line	5 μ H
Approvals	EAC
Type of remote signalling contact	break contact

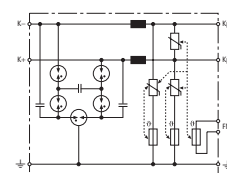

BVT KKS APD



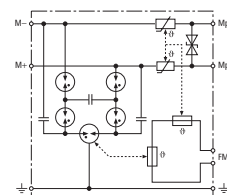

Combined arrester for protecting sensor measuring circuits. With integrated overcurrent element. With floating remote signalling contact (break contact). Installation into steel-sheet enclosure recommended.

Type BVT KKS ...	APD 36
Part No.	918 421
SPD class	TYPE 1 P1
Max. continuous operating voltage (d.c.) (U_c)	36.8 V
Nominal current (I_n)	0.05 A
D1 Total lightning impulse current (10/350 μ s) (I_{imp})	7 kA
C2 Total nominal discharge current (8/20 μ s) (I_n)	40 kA
Series resistance per line	55 ohms
Approvals	EAC
Type of remote signalling contact	break contact



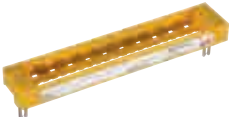
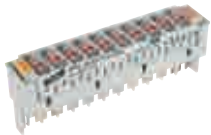

DEHN protects.®

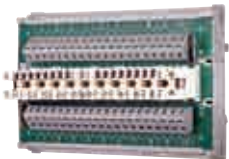
Product	Description	Type	Part No.	Page
Lightning current / surge arresters				
	<ul style="list-style-type: none"> – Lightning current carrying DRL plug-in SPD block can be easily plugged into LSA disconnection blocks of 2/10 type – Versions with / without fail-safe function / visual indication – Modularly expandable with a DRL protective plug to a combined lightning current and surge arrester – With integrated disconnection block contacts 	DRL 10 B 180 DRL 10 B 180 FSD	907 400 907 401	189 189
	<ul style="list-style-type: none"> – Protective plug for one pair inserted through the earthing frame into the DRL plug-in SPD block – Energy-coordinated with DRL plug-in SPD block – Low voltage protection level for application-specific protection of terminal equipment 	DRL ...	907 420 – 907 470	189 – 190
	<ul style="list-style-type: none"> – Snap-on earthing frame for earthing and mounting DRL protective plugs on a 10-pair disconnection block or the lightning current carrying DRL plug-in SPD block 	EF 10 DRL	907 498	191
Surge arresters				
	<ul style="list-style-type: none"> – Powerful SPD block can be easily plugged into LSA disconnection blocks of 2/10 type – Versions with / without fail-safe function / visual indication 	DPL 10 G3 110 DPL 10 G3 110 FSD	907 214 907 216	192 192
DEHN enclosure for equipotential bonding				
	<ul style="list-style-type: none"> – Lightning current carrying earthing system for arresters and shield connection – Pre-mounted mounting frame – Lockable enclosure 	DPG LSA ... P	906 100 – 906 103	193 – 193
Routing module for disconnection blocks with LSA spring-loaded terminal				
	<ul style="list-style-type: none"> – DIN rail mounted routing module for disconnection blocks – Equipped with LSA disconnection block and spring-loaded terminals for variable wire connection – Routing of different wire diameters 	TL2 10DA CC	907 991	195



DEHNrapid® LSA – Lightning Current / Surge Arrester



- Variable protection for 1 to 10 pairs in LSA systems of the 2/10 series
- LSA disconnection block function integrated in the lightning current arrester allows for protected testing, disconnecting and patching
- Modular system of lightning current and surge arresters can be combined to a single combined arrester

The DEHNrapid LSA arrester series is a modular system of lightning current arresters, surge arresters or combined lightning current and surge arresters that can be plugged into LSA disconnection blocks of series 2. The lightning current carrying 10-pair plug-in SPD block incorporates gas discharge tubes (optionally available with visual fault indication) and disconnection block contacts. This allows testing, disconnecting or patching of pairs with plugged-in protection or the additional attachment of single-pair surge arresters to ensure optimal protection of terminal equipment. The surge arresters snap into the earthing frame and can be removed as a block, whenever required.

nection block contacts. This allows testing, disconnecting or patching of pairs with plugged-in protection or the additional attachment of single-pair surge arresters to ensure optimal protection of terminal equipment. The surge arresters snap into the earthing frame and can be removed as a block, whenever required.

SPDs for LSA Technology

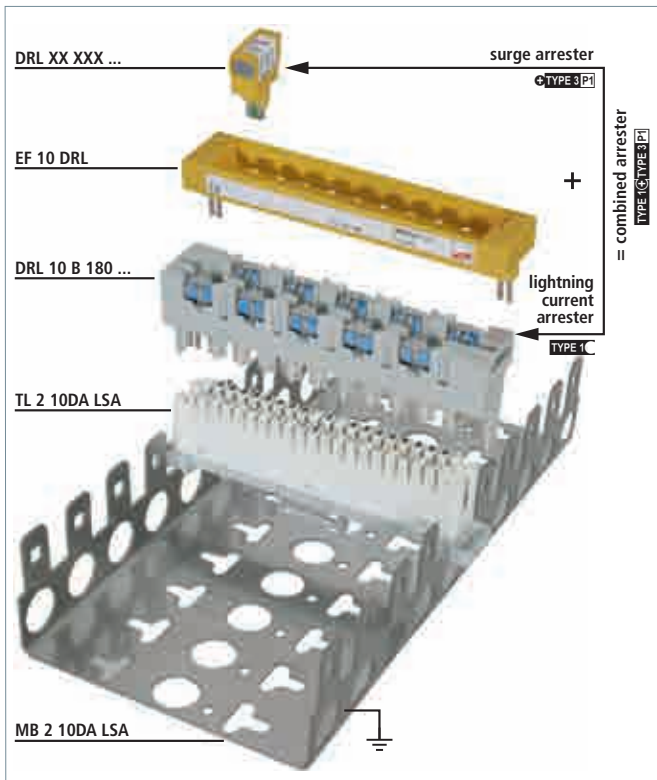

Modular design consisting of a plug-in SPD block with gas discharge tubes, earthing frame and application-specific protection modules.



Combined lightning current and surge arrester for LSA terminal blocks.



Lightning current carrying SPD block with gas discharge tubes optionally available with visual fault indication and fail-safe function.



Application-specific surge protection modules for protecting terminal equipment.



Pluggable surge arresters in the form of protection magazines can be plugged into terminal or disconnection blocks.

DRL 10 B

Lightning current carrying DRL plug-in SPD block (10 pairs), expandable with DRL protective plug. Integrated disconnection block contacts allow for protected testing, measuring and patching.

Type DRL ...	10 B 180
Part No.	907 400
SPD class	TYPE 1C
Max. continuous operating voltage (d.c.) (U_c)	180 V
Nominal current (I_L)	0.4 A
D1 Total lightning impulse current (10/350 μ s) (I_{imp})	5 kA
C2 Total nominal discharge current (8/20 μ s) (I_n)	10 kA
Series resistance per line	≤ 0.005 ohms
Plugs into	LSA disconnection block 2/10
Approvals	EAC

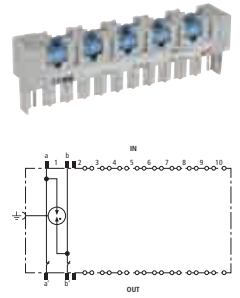

DRL 10 B FSD

Lightning current carrying DRL plug-in SPD block (10 pairs), expandable with DRL protective plug. Integrated disconnection block contacts allow for protected testing, measuring and patching. Arrester with fail-safe function and visual fault indicator.

Type DRL ...	10 B 180 FSD
Part No.	907 401
SPD class	TYPE 1C
Fault indication	visual, colour change
Max. continuous operating voltage (d.c.) (U_c)	180 V
Nominal current (I_L)	0.4 A
D1 Total lightning impulse current (10/350 μ s) (I_{imp})	5 kA
C2 Total nominal discharge current (8/20 μ s) (I_n)	10 kA
Series resistance per line	≤ 0.005 ohms
Plugs into	LSA disconnection block 2/10
Approvals	EAC

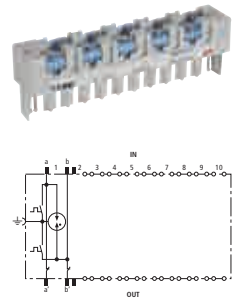

SPDs for LSA Technology

DRL RE

Single-stage protective plug (one pair) for signal circuits sharing a common potential. Earthing via EF 10 DRL earthing frame. For disconnection blocks or lightning current carrying DRL plug-in SPD blocks only.

General Information:	
SPD class	TYPE 3P1
D1 Total lightning impulse current (10/350 μ s) in combination with DRL 10 B... (I_{imp})	5 kA
C2 Total nominal discharge current (8/20 μ s) in combination with DRL 10 B... (I_n)	10 kA
Plugs into	LSA disconnection block 2/10 or DRL 10 B ... plug-in SPD block
Approvals	EAC

Type DRL ...	RE 5	RE 12	RE 24
Part No.	907 420	907 421	907 422
Max. continuous operating voltage (d.c.) (U_c)	6 V	14 V	28 V
Nominal current (I_L)	0.4 A	0.4 A	0.4 A
Series resistance per line	4.7 ohms	4.7 ohms	4.7 ohms
Cut-off frequency line-PG (f_G)	0.95 MHz	2.7 MHz	4.5 MHz

Type DRL ...	RE 48	RE 60	RE 180
Part No.	907 423	907 424	907 425
Max. continuous operating voltage (d.c.) (U_c)	54 V	70 V	180 V
Nominal current (I_L)	0.4 A	0.4 A	0.1 A
Series resistance per line	6.8 ohms	6.8 ohms	4.7 ohms
Cut-off frequency line-PG (f_G)	7.35 MHz	10.5 MHz	42 MHz

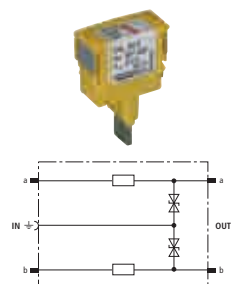

DRL RD

Single-stage protective plug (one pair) for galvanically isolated interfaces. To be mounted into EF 10 DRL earthing frames. Installation recommended only in combination with lightning current carrying DRL plug-in SPD block.

General Information:	
SPD class	⚡TYPE 3 P1
Nominal current (I_n)	0.4 A
D1 Total lightning impulse current (10/350 μ s) in combination with DRL 10 B... (I_{imp})	5 kA
C2 Total nominal discharge current (8/20 μ s) in combination with DRL 10 B... (I_n)	10 kA
Plugs into	LSA disconnection block 2/10 or DRL 10 B ... plug-in SPD block
Approvals	EAC

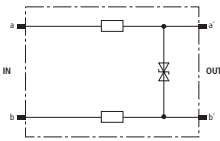

Type DRL ...	RD 5	RD 12	RD 24
Part No.	907 440	907 441	907 442
Max. continuous operating voltage (d.c.) (U_c)	6 V	14 V	28 V
Series resistance per line	2.2 ohms	2.2 ohms	2.2 ohms
Cut-off frequency line-line (f_G)	1 MHz	2.7 MHz	5.4 MHz

Type DRL ...	RD 48	RD 60	RD 110
Part No.	907 443	907 444	907 445
Max. continuous operating voltage (d.c.) (U_c)	54 V	70 V	180 V
Series resistance per line	4.7 ohms	4.7 ohms	4.7 ohms
Cut-off frequency line-line (f_G)	7.8 MHz	11 MHz	20 MHz

DRL PD

Single-stage protective plug with overcurrent protection (one pair) for ADSL, ISDN U_{k0} or a/b lines. To be mounted into EF 10 DRL earthing frames. Installation recommended only in combination with lightning current carrying DRL plug-in SPD block.

Type DRL ...	PD 180
Part No.	907 430
SPD class	⚡TYPE 3 P1
Max. continuous operating voltage (d.c.) (U_c)	180 V
Nominal current (I_n)	0.1 A
D1 Total lightning impulse current (10/350 μ s) in combination with DRL 10 B... (I_{imp})	5 kA
C2 Total nominal discharge current (8/20 μ s) in combination with DRL 10 B... (I_n)	10 kA
Series resistance per line	10 ohms +/- 15%
Cut-off frequency line-line (f_G)	61 MHz
Plugs into	LSA disconnection block 2/10 or DRL 10 B... plug-in SPD block
Approvals	EAC

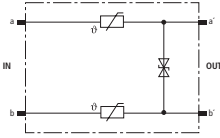

DRL HD

Single-stage protective plug (1 pair) for high-frequency transmissions (e.g. ISDN U_{2m} , S_{2m} and S_0). HD 5 type for RS 485 bus systems. To be mounted into EF 10 DRL earthing frames. Installation recommended only in combination with lightning current carrying DRL plug-in SPD block.

Type DRL ...	HD 24
Part No.	907 470
SPD class	⚡TYPE 3 P1
Max. continuous operating voltage (d.c.) (U_c)	28 V
Nominal current (I_n)	0.4 A
D1 Total lightning impulse current (10/350 μ s) in combination with DRL 10 B... (I_{imp})	5 kA
C2 Total nominal discharge current (8/20 μ s) in combination with DRL 10 B... (I_n)	10 kA
Series resistance per line	4.7 ohms
Cut-off frequency line-line (f_G)	94 MHz
Plugs into	LSA disconnection block 2/10 or DRL 10 B... plug-in SPD block
Approvals	EAC

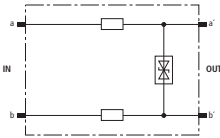



Accessories for DEHNrapid® LSA

Plug-in SPD Block (without SPDs)

Plug-in SPD block (without SPDs) for 1 to max. 10 three-pole GDT 230 B3 ... gas discharge tubes. Also suitable for DRL protective plugs with earthing frame.

Type	BM 10 DRL
Part No.	907 499
Plugs into	LSA disconnection blocks
Earthing via	mounting frame



Gas Discharge Tube

High-capacity replacement gas discharge tube for DRL 10 or BM 10 DRL. Three-pole version with common arcing chamber for a constant voltage protection level line-line and line-ground.

Type	GDT 230 B3 FSD
Part No.	907 219
Integrated into Part No.	907 401
Visual fault indication	yes
Fail-safe spring	yes
D1 Total lightning impulse current (10/350 µs)	5 kA



Gas Discharge Tube

High-capacity replacement gas discharge tubes for DRL 10 or BM 10 DRL. Three-pole version with common arcing chamber for a constant voltage protection level line-line and line-ground.

Type	GDT 230 B3
Part No.	907 218
Integrated into Part No.	907 400
D1 Total lightning impulse current (10/350 µs)	5 kA



Earthing Frame

Snap-on earthing frame for earthing and installation of max. 10 DRL protection modules. Plugs into a 10-pair disconnection block or DRL plug-in SPD block.

Type	EF 10 DRL
Part No.	907 498
Plugs into	LSA disconnection blocks or DRL plug-in SPD block
Earthing via	mounting frame or DRL plug-in SPD block

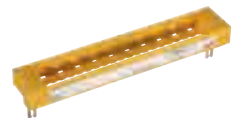

Label Holder

Universal label holder made of stainless steel for clear identification of LSA connections. Can be snapped onto DEHNrapid LSA plug-in SPD blocks, earthing frames with protective plugs or mounting frames with LSA blocks of the 2/10 series.

Type	SR DRL
Part No.	907 497
Plugs into	DRL B, EF DRL, LSA blocks 2/10 (profile, with earth connecting clip)



Earthing Module

Earthing module for directly connecting two unused lines to the equipotential bonding system.

Type	EM 2 DRL
Part No.	907 496
D1 Total lightning impulse current (10/350 µs)	5 kA
Plugs into	TL2 10DA ...
Earthing via	EF 10 DRL
Material	zinc die-casting
Approvals	EAC





DPL 10 G3



Pluggable arresters for use in LSA systems of the 2/10 series. For use as protection block for 10 pairs with individually exchangeable protection elements.

- Suitable for disconnection or terminal blocks of LSA systems of the 2/10 series
- Equipped with individually tested gas discharge tubes for ten pairs
- Individually exchangeable protection elements (gas discharge tubes)

Pluggable surge arresters for use as protection blocks in IT systems and devices which have to be connected via terminal or disconnection blocks using the LSA insulation displacement method. Installation onto terminal blocks, however, is the preferred method, as their contact forces provide better fixation – even in case of slight vibrations.

The surge arresters for 10 pairs can be easily installed and removed for testing purposes. Contact to earth via the mounting frame is automatically established as soon as the arrester is plugged in. After being overloaded, the protection elements can be individually replaced.

DPL 10 G3

Plug-in SPD block for ten pairs with three-pole gas discharge tubes for almost all applications. FSD arresters feature a fail-safe function and an additional visual indication when the fail-safe function has been activated. Thus it can be immediately identified whether an arrester has to be replaced.

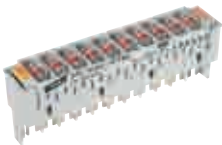

Type DPL 10 G3 ...	110	110 FSD
Part No.	907 214	907 216
SPD class	TYPE 2	TYPE 2
Fault indication	—	visual, colour change
Max. continuous operating voltage (d.c.) (U_c)	180 V	180 V
Nominal current (I_n)	0.4 A	0.4 A
C2 Total nominal discharge current (8/20 μ s) (I_n)	10 kA	10 kA
Approvals	EAC	EAC

Accessories for DPL 10 G3

Gas Discharge Tube

High-capacity replacement gas discharge tubes for DPL 10 G3. Three-pole version with common arcing chamber for a constant voltage protection level line-line and line-ground.



Type	GDT 230 G3	GDT 230 G3 FSD
Part No.	907 208	907 217
Integrated into Part No.	907 214	907 216
Visual fault indication	—	yes
Fail-safe spring	—	yes



DEHN Enclosure for Equipotential Bonding

- Premounted enclosure system for wiring and protection components
- Tested lightning impulse current carrying capacity
- Optimised for equipotential bonding (surge arresters and shield connection)
- Lockable metal enclosure to prevent against unauthorised access

Lightning current carrying enclosure with IP 40 degree of protection for different distribution board designs and for the insertion of surge arresters. The cover can be removed from the wall plate without tools and features a lock with cylinder quarter turn and a key. The C-shaped design of the wall plate allows side and front access during installation work. LSA mounting frames or DIN rails can be mounted on the wall plate with cable entry plates and cable rails.

Despite a high packing density, structured cable management is ensured – crossing of cables with wires is avoided and the cables of e.g. the LSA blocks are clearly structured due to the 30 mm grid dimensions. For this kind of cabling, an optional shield connection system is available (constant force spring). The well-conceived earthing system permanently connects all conductive components of the enclosure system to the earthing block via mechanical contact or earthing conductors.



DEHN enclosures for equipotential bonding (DPG) are lockable metal enclosures for installation of wiring and protection components. Available in four different sizes, the lightning current carrying enclosures provide terminals that allow to integrate surge arresters and shields into the equipotential bonding system.



DEHN enclosures for equipotential bonding (DPG) come in different sizes, allowing the insertion of 3/6/12/22 LSA blocks. Even if 20/50/100/200 pairs are connected, enough space is provided for the earthing plug for inserting the earth drain wires.



All equipotential bonding conductors are led together in the central earthing block.



The shields of incoming lines can be contacted with SA KRF constant force springs in a space-saving and lightning-current-carrying way.



The enclosure for equipotential bonding can be locked (key supplied with the enclosure).

SPDs for LSA Technology

DPG LSA

DPG LSA is a completely premounted enclosure system with LSA mounting frame and allows optimised use of arresters and shield connection systems (constant force spring).

Type DPG LSA ...	30 P	60 P	120 P	220 P
Part No.	906 100	906 101	906 102	906 103
Carrying capacity of connection elements D1 Total lightning impulse current (10/350 µs) (I _{imp})	15 kA	30 kA	50 kA	50 kA
LSA mounting frame for	1x 3 blocks 2/10	1x 6 blocks 2/10	2x 6 blocks 2/10	2x 11 blocks 2/10
Wire guides	1 pc(s).	2 pc(s).	2 pc(s).	3 pc(s).
Degree of protection	IP 40	IP 40	IP 40	IP 40
Dimensions W x H x D	240 x 260 x 130 mm	240 x 350 x 130 mm	330 x 350 x 130 mm	330 x 500 x 130 mm



Accessories for DEHN Enclosure for Equipotential Bonding

Self-bonding Rubber Tape

Roll with 9 m self-bonding rubber tape to be wrapped around constant force springs for permanent corrosion protection.

Type	SKB 19 9M SW
Part No.	919 030
Colour	black ●



Constant Force Spring

Constant force springs allow solderless shield connections for equipotential bonding or lightning equipotential bonding. They can be installed subsequently without interrupting the cable shield or requiring tools for installation. Approved for nuclear installations according to TÜV Certificate No. T12-04-ETL003 (TÜV = German Technical Inspectorate).

Type	SA KRF 10 V2A	SA KRF 15 V2A	SA KRF 22 V2A	SA KRF 29 V2A	SA KRF 37 V2A
Part No.	919 031	919 032	919 033	919 034	919 035
Material	StSt	StSt	StSt	StSt	StSt
Clamping range	4-10 mm	9-15 mm	14-22 mm	18.5-29 mm	23.5-37 mm





Accessories for LSA Technology

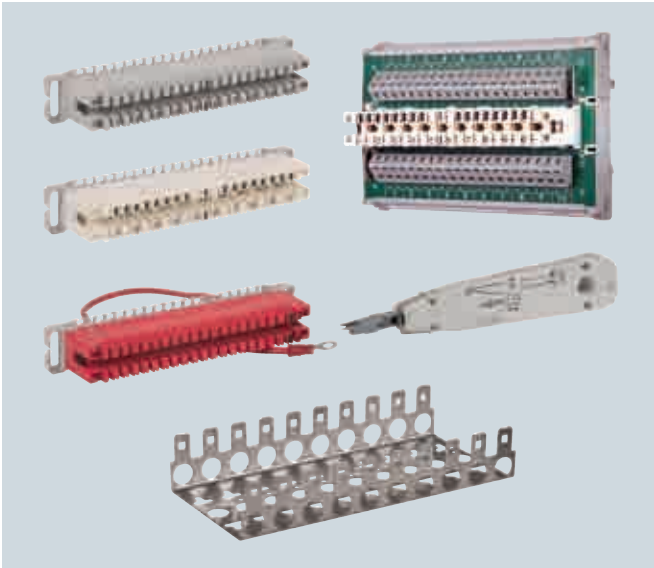

- Proven insulation displacement method
- 45° angled blades in the disconnection block ensure a minimum change in cross-section
- Enhanced stability of the conductor
- Enhanced corrosion resistance
- Further accessories available on request

The insulation displacement method is used for quickly connecting several lines at reasonable costs. This method is commonly used in the telecommunications sector (e.g. Deutsche Telekom AG).

The blocks are suitable for connecting plastic-insulated wires with copper conductor material:

Conductor diameter: 0.4-0.8 mm

Outer diameter: 0.7-1.5 mm

After using wires with a conductor diameter of 0.65 mm, rewiring to smaller diameters is no longer possible.

Mounting Frame

Mounting frame for 10 LSA blocks of the 2/10 series, total width: 104.5 mm

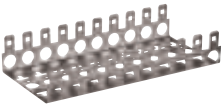

Type	MB2 10 LSA
Part No.	907 995
Dimensions	223 x 105 x 42 mm

Insertion Tool

Insertion tool with sensor for LSA technology for connecting the wires and simultaneously cutting them to the required length. With fold-out extraction hook and blade.



Type	AW2 LSA
Part No.	907 994
Colour	white

Terminal Block

Series 2 for LSA technology for inseparably connecting 10 pairs each on the cable and routing side. Accommodates DPL 10 G3 arresters. Parallel protective circuit only.



Type	AL2 10DA LSA
Part No.	907 997
Test standards	DIN 47608-1, -2
Diameter of solid conductors	0.40-0.80 mm
Conductor diameter with insulation	0.70-1.50 mm

Disconnection Block

Series 2 for LSA technology for connecting 10 pairs each on the cable and routing side. Protection is provided between the disconnection contacts as soon as DRL components are plugged in. DPL 10 G3 arresters can also be plugged into the disconnection block.

Type	TL2 10DA LSA
Part No.	907 996
Test standards	DIN 47608-1, -2
Approvals	compliance with DTAG TS 0272/96
Diameter of solid conductors	0.40-0.80 mm
Conductor diameter with insulation	0.70-1.50 mm



Earthing Plug

Series 2 for LSA technology for connecting up to 38 earth drain wires or unused signal cores. With earth wire and M4 ring cable lug.

Type	EL2 38EA LSA
Part No.	907 993
Earthing via	earthing conductor with M4 ring cable lug
Diameter of solid conductors	0.40 - 0.80 mm
Conductor diameter with insulation	0.70 - 1.50 mm
Colour	red



Routing Module for Disconnection Blocks with LSA spring-loaded Terminal

DIN rail mounted routing module with LSA disconnection block of the 2/10 series as well as spring-loaded terminals for variable wire connection. DPL and DEHNrapid LSA surge arresters can be plugged into the routing module.



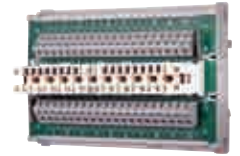







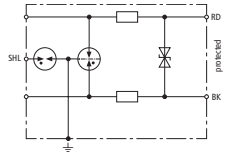

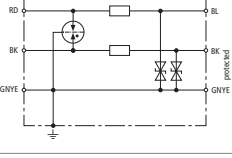

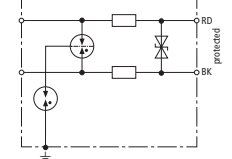
Type	TL2 10DA CC
Part No.	907 991
Carrying capacity of connection components D1 Total lightning impulse current (10/350 μ s) (I_{imp})	5 kA
For mounting on	35 mm DIN rails acc. to EN 60715
Connection (input / output)	spring or LSA / spring or LSA
Earthing via	DIN rail / flat connector 6.3 mm
Diameter of solid conductors	0.40-0.80 mm
Conductor diameter with insulation	0.70-1.60 mm

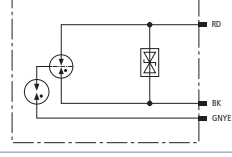

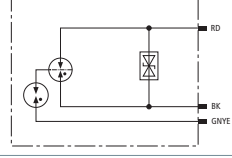

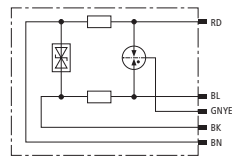
DEHN protects.®

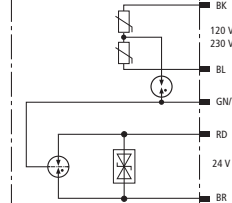
SPDs for Field Devices

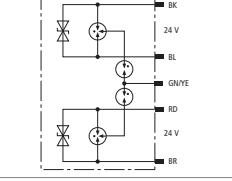
Product	Basic circuit diagram	Type	Part No.	Page
DEHNpipe MD / ME				
		DPI MD <ul style="list-style-type: none"> For one balanced interface Direct or indirect shield earthing Nominal voltage: 24 V For series connection With M20 x 1.5 thread (female/male) 	929 941	198
		DPI ME <ul style="list-style-type: none"> For one unbalanced interface Nominal voltage: 24 V For series connection With 1/2-14 NPT thread (male/male) 	929 921	198
DEHNpipe MD Ex (i)				
		DPI MD EX <ul style="list-style-type: none"> For one balanced interface Nominal voltage: 24 V For series connection With M20 x 1.5 or 1/2-14 NPT thread 	929 960 929 965	199 199
DEHNpipe CD Ex (i)				
		DPI CD EXI <ul style="list-style-type: none"> For one balanced interface Nominal voltage: 24 V For parallel connection With M20 x 1.5 or 1/2-14 NPT thread 	929 961 929 963	199 199
DEHNpipe CD Ex (d)				
		DPI CD EXD 24 <ul style="list-style-type: none"> For one balanced interface Nominal voltage: 24 V For parallel connection With M20 x 1.5 or 1/2-14 NPT thread 	929 962 929 964	199 199
		DPI CD HF EXD 5 <ul style="list-style-type: none"> For one balanced interface Nominal voltage: 5 V For series connection With M20 x 1.5 thread 	929 971	199
		DPI CD EXD 230 24 <ul style="list-style-type: none"> For one balanced interface and one 120/230 V power supply system Nominal voltage: 24 V and 120/230 V For parallel connection With M20 x 1.5 or 1/2-14 NPT thread 	929 969 929 970	200 200
DEHNpipe CD Ex (i) + Ex (d)				
		DPI CD EXI+D 2x24 <ul style="list-style-type: none"> For two balanced interfaces Nominal voltage: 24 V For parallel connection With M20 x 1.5 or 1/2-14 NPT thread 	929 950 929 951	200 200



DEHNpipe



Surge arrester for outdoor use to be screwed onto two-wire field devices. Stainless steel, installation with cable gland up to IP 67.

- Surge arresters to be screwed onto field devices
 - Parallel or series connection
 - Made of corrosion-resistant stainless steel
 - Arrester for protecting a second interface (data or power side) available
- Types for Ex (i) and Ex (d) applications
 - For protecting intrinsically safe measuring circuits and bus systems Ex (i)
 - Type in a flameproof enclosure Ex (d)
- Variety of approvals
 - Approvals depending on the arrester: IECEx, ATEX, FISCO, CSA Hazloc

The devices of the DEHNpipe family are made of corrosion-resistant stainless steel and can be directly screwed onto a field device. The permanently connected lines are connected to the terminals of the field device. Surge protective devices for series connection and parallel connection are available. Arresters for series connection are located directly in the cable run which ensures energy coordination with other arresters. These arresters can also be used for field devices with a single field device terminal or a single cable gland. Arresters for parallel connection are attached to the spare cable gland of the field devices or in the field bus distributor and are situated in parallel to the cable run. Due to their design, both versions have an IP 67 degree of protection.

Ex(i) und Ex(d) versions are available for field devices in potentially explosive atmospheres. Depending on the type, the arresters can thus be installed on field devices in intrinsically safe measuring circuits Ex(i) or on devices with flameproof enclosure and are suitable for use in Ex zone 1 or 2. The surge arresters are ideally suited for installation in process environments, for example on transducers or field bus devices. 4-20 mA measuring circuits or bus systems up to 30 V are typical fields of application.



Types for series connection.



Robust type made of corrosion-resistant stainless steel.



Metric and NPT thread.

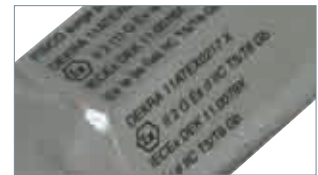

ATEX and IECEx approval.

SPDs for Field Devices

DPI MD

Energy-coordinated two-stage arrester, no leakage currents to earth, for 4-20 mA interfaces with M20 x 1.5 thread (female/male). Direct, indirect or no shield earthing. Cable gland available as accessory part.

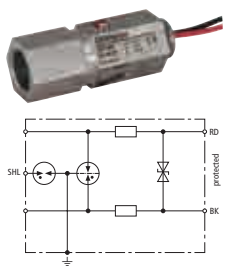

Type DPI ...	MD 24 M 2S
Part No.	929 941
SPD class	TYPE 2P1
Max. continuous operating voltage (d.c.) (U _c)	34.8 V
Nominal current (I _n)	0.5 A
D1 Lightning impulse current (10/350 μs) per line (I _{imp})	1 kA
C2 Total nominal discharge current (8/20 μs) (I _n)	10 kA
Cut-off frequency line-line (f _c)	14 MHz
For mounting on (field / device side)	M20 x 1.5 female thread / M20 x 1.5 male thread
Approvals	EAC, SIL

DPI ME

Energy-coordinated two-stage arrester for unbalanced interfaces with 1/2-14 NPT thread (male/male). The earthing conductor is led through the surge arrester.

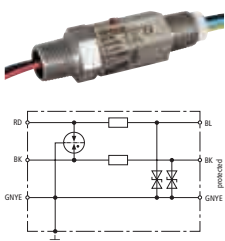

Type DPI ...	ME 24 N A2G
Part No.	929 921
SPD class	TYPE 2P1
Max. continuous operating voltage (d.c.) (U _c)	34.8 V
Nominal current (I _n)	0.5 A
D1 Lightning impulse current (10/350 μs) per line (I _{imp})	1 kA
C2 Total nominal discharge current (8/20 μs) (I _n)	10 kA
For mounting on (field / device side)	1/2-14 NPT male thread / 1/2-14 NPT male thread
Approvals	UL, EAC, SIL

DPI MD EX

Energy-coordinated two-stage surge arrester for protecting intrinsically safe measuring circuits and bus systems according to FISCO. Cable glands are available as accessory.

Type DPI ...	MD EX 24 M 2	MD EX 24 N 2
Part No.	929 960	929 965 ^{NEW}
SPD class	TYPE 2 P1	TYPE 2 P1
Max. continuous operating voltage (d.c.) (U _c)	34.8 V	34.8 V
Nominal current (I _n)	0.5 A	0.5 A
D1 Lightning impulse current (10/350 μs) per line (I _{imp})	1 kA	1 kA
C2 Total nominal discharge current (8/20 μs) (I _n)	10 kA	10 kA
Cut-off frequency line-line (f _c)	7 MHz	7 MHz
For mounting on (field / device side)	M20 x 1.5 female thread / M20 x 1.5 male thread	1/2-14 NPT female thread / 1/2-14 NPT male thread
Approvals	EACEx, ATEX, IECEx, SIL	ATEX, IECEx, SIL

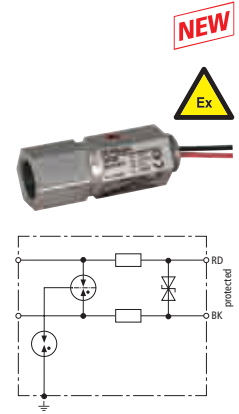

DPI CD EXI

Surge arrester for protecting intrinsically safe measuring circuits and bus systems according to FISCO.

Type DPI ...	CD EXI 24 M	CD EXI 24 N
Part No.	929 961	929 963
SPD class	TYPE 2 P1	TYPE 2 P1
Max. continuous operating voltage (d.c.) (U _c)	32 V	32 V
Nominal current (I _n)	0.55 A	0.55 A
D1 Lightning impulse current (10/350 μs) line-PG (I _{imp})	1 kA	1 kA
C2 Total nominal discharge current (8/20 μs) (I _n)	10 kA	10 kA
Cut-off frequency line-line (f _c)	67 MHz	67 MHz
For mounting on (field / device side)	M20 x 1.5 male thread	1/2-14 NPT male thread
Approvals	EACEx, ATEX, IECEx, CSA & USA Hazloc, SIL	EACEx, ATEX, IECEx, CSA & USA Hazloc, SIL

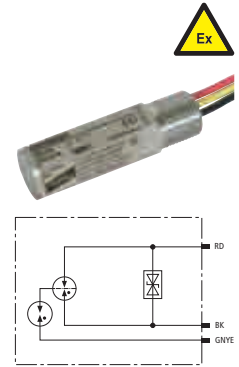

DPI CD EXD

Surge arrester in a flameproof enclosure for protecting measuring circuits and bus systems in potentially explosive atmospheres.

Type DPI ...	CD EXD 24 M	CD EXD 24 N
Part No.	929 962	929 964
SPD class	TYPE 2 P1	TYPE 2 P1
Max. continuous operating voltage (d.c.) (U _c)	32 V	32 V
Nominal current (I _n)	0.55 A	0.55 A
D1 Lightning impulse current (10/350 μs) line-PG (I _{imp})	1 kA	1 kA
C2 Total nominal discharge current (8/20 μs) (I _n)	10 kA	10 kA
Cut-off frequency line-line (f _c)	67 MHz	67 MHz
For mounting on (field / device side)	M20 x 1.5 male thread	1/2-14 NPT male thread
Approvals	EACEx, ATEX, IECEx, CSA & USA Hazloc, SIL	EACEx, ATEX, IECEx, CSA & USA Hazloc, SIL

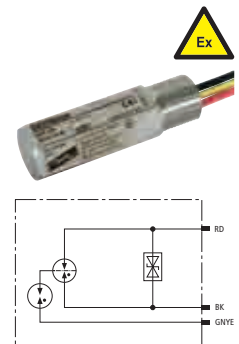

DPI CD HF EXD

Surge arrester in a flameproof enclosure for protecting measuring circuits and bus systems with high-frequency signals in potentially explosive atmospheres.

Type DPI ...	CD HF EXD 5 M
Part No.	929 971
SPD class	TYPE 2 P1
Max. continuous operating voltage (d.c.) (U _c)	6 V
Nominal current at 80 °C (I _n)	0.1 A
C2 Total nominal discharge current (8/20 μs) (I _n)	20 kA
Cut-off frequency line-line (f _c)	100 MHz
For mounting on (field / device side)	M20 x 1.5 male thread
Approvals	EACEx, ATEX, IECEx, SIL

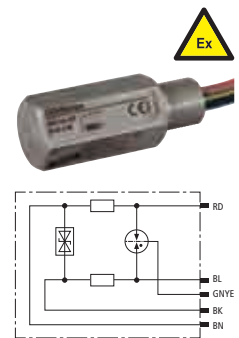

NEW



SPDs for Field Devices

DPI CD EXD 230 24

Surge arrester in a flameproof enclosure for protecting 120/230 V terminal equipment and 0/4-20 mA interfaces in potentially explosive atmospheres.

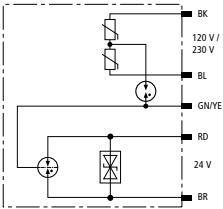

Type DPI ...	CD EXD 230 24 M	CD EXD 230 24 N
Part No.	929 969	929 970
Protection of the data side		
SPD class	TYPE 2 P2	TYPE 2 P2
Max. continuous operating voltage (d.c.) (U _c)	32 V	32 V
Nominal current at 80 °C (I _n)	0.55 A	0.55 A
D1 Lightning impulse current (10/350 μs) line-PG (I _{imp})	1 kA	1 kA
C2 Total nominal discharge current (8/20 μs) (I _n)	10 kA	10 kA
For mounting on (field / device side)	M20 x 1.5 male thread	1/2-14 npt male thread
Approvals	EACEx, ATEX, IECEx, CSA & USA Hazloc, SIL	EACEx, ATEX, IECEx, CSA & USA Hazloc, SIL
Protection of the power side		
SPD according to EN 61643-11 / IEC 61643-11	type 2 / class II	type 2 / class II
Max. continuous operating voltage (a.c.) (U _c)	255 V	255 V
Total discharge current (8/20 μs) L+N-PE (I _{total})	5 kA	5 kA
Voltage protection level L-N (U _p)	≤ 1.4 kV	≤ 1.4 kV
Max. mains-side overcurrent protection	16 A gL/gG or B 16 A	16 A gL/gG or B 16 A

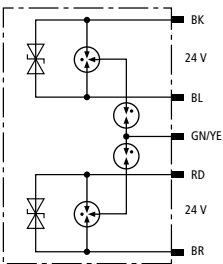
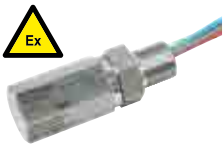

DPI CD EXI+D 2X24

Surge arrester in a flameproof enclosure for protecting two 24 V interfaces in potentially explosive atmospheres according to FISCO.

Type DPI ...	CD EXI+D 2X24 M	CD EXI+D 2X24 N
Part No.	929 950	929 951
Protection of the data side		
SPD class	TYPE 2 P1	TYPE 2 P1
Max. continuous operating voltage (d.c.) (U _c)	36 V	36 V
Nominal current (I _n)	0.55 A	0.55 A
D1 Lightning impulse current (10/350 μs) line-PG (I _{imp})	1.5 kA	1.5 kA
C2 Total nominal discharge current (8/20 μs) (I _n)	20 kA	20 kA
For mounting on (field / device side)	M20 x 1.5 male thread	1/2-14 NPT male thread
Approvals	EACEx, ATEX, IECEx, CSA & USA Hazloc, SIL	EACEx, ATEX, IECEx, CSA & USA Hazloc, SIL

SPDs for Field Devices

Accessories for DEHNpipe

EMC Cable Gland

Brass gland with shield connection



Type	KV S M20 MS 9.5
Part No.	929 982
Sealing range (Rd)	6.5-9.5 mm
Shield diameter	3.2-6.5 mm
For mounting on	M20 x 1.5
Degree of protection	IP 68

Cable Gland

Brass gland without shield connection



Type	KV M20 MS 10.5
Part No.	929 984
Sealing range (Rd)	7.0-10.5 mm
For mounting on	M20 x 1.5
Degree of protection	IP 68







Brass Earthing Ring

Earthing ring made of nickel-plated brass, for externally earthing DPI devices.



Type	ER DPI M20
Part No.	929 996
For mounting on	DPI M20 x 1.5

List of Approvals (as of December 2017)

Part No.	Type	ATEX 	IECEx 	CSA-Hazloc 	SIL (up to SIL3)	UL 	EAC 	EAC 
929 941	DPI MD 24 M 25				•		•	
929 921	DPI ME 24 N A2G				•	•	•	
929 960	DPI MD EX 24 M 2	•(1)	•(2)		•			•(13)
929 965	DPI MD EX 24 N 2	•(1)	•(2)		•			
929 961	DPI CD EXI 24 M	•(3)	•(4)	•(12)	•			•(13)
929 963	DPI CD EXI 24 N	•(3)	•(4)	•(12)	•			•(13)
929 962	DPI CD EXD 24 M	•(5)	•(6)	•(11)	•			•(14)
929 964	DPI CD EXD 24 N	•(5)	•(6)	•(11)	•			•(14)
929 971	DPI CD HF EXD 5 M	•(5)	•(6)		•			•(14)
929 969	DPI CD EXD 230 24 M	•(7)	•(8)	•(11)	•			•(14)
929 970	DPI CD EXD 230 24 N	•(7)	•(8)	•(11)	•			•(14)
929 950	DPI CD EXI+D 2x24 M	•(9)	•(10)	•(12)	•			•(15)
929 951	DPI CD EXI+D 2x24 N	•(9)	•(10)	•(12)	•			•(15)

(1)	DEKRA 11ATEX0076 X: II 2(1) G Ex ia [ia Ga] IIC T4 ... T6 Gb
(2)	DEK 11.0025X: Ex ia [ia Ga] IIC T4 ... T6 Gb
(3)	KEMA 04ATEX1189 X: II 2(1) G Ex ia IIC T5 ... T6 Gb
(4)	KEM 09.0076X: Ex ia [ia Ga] IIC T5 ... T6 Gb
(5)	KEMA 04ATEX2190 X: II 2 G Ex d IIC T5 or T6 Gb
(6)	KEM 09.0064X: Ex d IIC T5 or T6 Gb
(7)	KEMA 10ATEX0114 X: II 2 G Ex d IIC T5 or T6 Gb
(8)	DEK 11.0006X: Ex d IIC T5 or T6 Gb
(9)	DEKRA 11ATEX0207 X: II 2(1) G Ex ia [ia Ga] IIC T5/T6 Gb DEKRA 11ATEX0217 X: II 2 G Ex db IIC T6...T5 Gb
(10)	IECEx DEK 11.0076X: Ex ia [ia Ga] IIC T5/T6 Gb IECEx DEK 11.0079X: Ex db IIC T6 ... T5 Gb

(11)	CSA 10.2317168: Ex d IIC T4 ... T6 CSA 10.2317168: Class I Div 1, 2; Group A,B,C,D T4 ... T6 CSA 10.2317168: Class II Div 1, 2; Group E,F,G CSA 10.2317168: Class III Div 1, 2 CSA 10.2317168: Class I, AEx d IIC T4 ... T6
(12)	CSA 13.70000407: Class I, Zone 1, AEx ia [ia] IIC T5 ... T6 CSA 13.70000407: Class I, Zone 1, AEx nA IIC T5 ... T6 CSA 13.70000407: IS, Class I, Div 1, Group A,B,C,D,E,F,G T5 ... T6 CSA 13.70000407: Class I,II,III; Div 2, Group A,B,C,D,E,F,G T5 ... T6 CSA 13.70000407: Ex ia [ia] IIC T5
(13)	EAC TC RU C-DE.GB06.B00505 0ExIICT5/T6
(14)	EAC TC RU C-DE.GB06.B00505 1ExdIICT5/T6 X
(15)	EAC TC RU C-DE.GB06.B00505 0ExIICT5/T6 X EAC TC RU C-DE.GB06.B00505 1ExdIICT5/T6 X

For more detailed information on approvals and SIL, please visit www.dehn-international.com



DEHN protects.®



DEHNpatch

- Patch cable with surge protection
- Cat. 6 according to ISO/IEC 11801
- CAT 6A in the channel according to ANSI/TIA/EIA-568
- Power over Ethernet IEEE 802.3 compliant (up to PoE++ / 4PPoE)
- IP66 variant for outdoor applications
- Easy to retrofit



DEHNpatch is the first Cat. 6A certified patch cable with surge protection that can be used according to IEEE 802.3at up to 57 V.

Surge arresters of the DEHNpatch family fulfill various requirements for a universal application for Ethernet, Industrial Ethernet, Power over Ethernet (IEEE 802.3 compliant up to PoE++ / 4PPoE) as well as general applications in structured cabling up to the Gbit range. Due to the different product designs the SPDs are suitable for indoor and outdoor installation in different environmental conditions.

The space-saving design of the DEHNpatch surge arrester as patch cable or as compact socket-socket design is especially easy to install. Thus, not only new systems can be equipped easily but also retrofitting is possible anytime without great effort. Due to its fully shielded design, DEHNpatch can be used in shielded and unshielded networks.

DEHNpatch is installed between patch panel and active component (e.g. switch). A safe equipotential bonding is provided by the surge current resistant DIN rail supporting foot with snap-in mechanism. Standard DEHNpatch will be supplied with integrated patch cable with a length of

3 m. Arresters with other, customised cable lengths are available upon request up to a total cable length of 10 m.

The width of the DIN rail mounting devices is similar to that of an RJ45 socket, allowing up to 24 devices to be installed next to one another in a 19" rack. For multiple application in 19" distribution boards a DEHNpatch mounting set is recommended which is available as accessory.

The IP66 version of DEHNpatch with its universal mounting device, especially developed for outdoor applications, can be installed on poles as well as on walls. The arrester is directly earthed via the metal enclosure. Screws in the enclosure cover are secured against falling out which facilitates installation also at great heights (e.g. on poles). Special cable seals enable an easy and low-effort installation of the arrester with pre-assembled patch cables. An additional effort of mounting RJ45 plugs on the building entry cable can be omitted.



With RJ45 sockets, fully shielded.



With IP66 degree of protection suitable for outdoor application.



Patch cable version, fully shielded.



Mounting set (DIN rail, distance bolts) for 19" mounting sections available as accessory.

SPDs for Tel. and Data Networks

DPA CLE IP66

Universal surge arrester for GBit Ethernet applications, Power over Ethernet (IEEE 802.3 compliant up to PoE++ / 4PPoE) and similar applications in structured cabling systems in indoor and outdoor areas in an IP66 rated enclosure impervious to dust and water jets. Protection of all pairs with gas discharge tubes and one adapted filter matrix for each pair. Fully shielded surge protective solution with RJ 45 sockets. Universal mounting bracket for pole and wall mounting.

External accessories: Tensioning straps for pole mounting

Type DPA ...	CLE IP66
Part No.	929 221 <small>NEW</small>
SPD class	TYPE 2 P1
Max. continuous operating voltage (d.c.) pair-pair (PoE) (U _c)	60 V
Nominal current (I _n)	1 A
D1 Lightning impulse current (10/350 μs) per line (I _{imp})	0.8 kA
C2 Total nominal discharge current (8/20 μs) line-PG (I _n)	10 kA
Cut-off frequency (f _c)	250 MHz
Degree of protection (with installed cables)	IP 66
Connection (input / output)	RJ45 socket / RJ45 socket
Approvals	UL, CSA, EAC

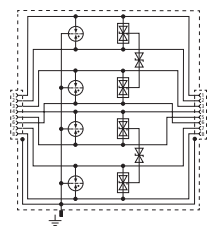

DPA M CAT6

Universal arrester for Industrial Ethernet, Power over Ethernet (IEEE 802.3 compliant up to PoE++ / 4PPoE) and similar applications in structured cabling systems according to Cat. 6 and class E_A up to 500 MHz. Fully shielded type for DIN rail mounting, cable length of 3 m*).

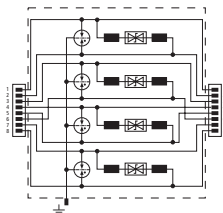

Type DPA ...	M CAT6 RJ45S 48
Part No.	929 100
SPD class	TYPE 2 P1
Max. continuous operating voltage (d.c.) (U _c)	48 V
Max. continuous operating voltage (d.c.) pair-pair (PoE) (U _c)	57 V
Nominal current (I _n)	1 A
D1 Lightning impulse current (10/350 μs) per line (I _{imp})	1 kA
C2 Total nominal discharge current (8/20 μs) line-PG (I _n)	10 kA
Cut-off frequency (f _c)	250 MHz
Connection (input / output)	RJ45 connecting line / RJ45 connecting line
Approvals	GHMT, EAC

*) Special lengths on request

DEHNpatch Class E

Universal arrester ideally suited for Industrial Ethernet, Power over Ethernet (IEEE 802.3 compliant up to PoE++ / 4PPoE) and similar applications in structured cabling systems according to class E up to 250 MHz. Fully shielded adapter with sockets for DIN rail mounting.

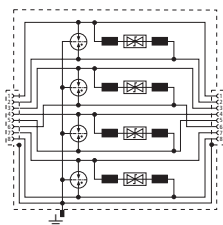

Type DPA ...	M CLE RJ45B 48
Part No.	929 121
SPD class	TYPE 2 P1
Max. continuous operating voltage (d.c.) (U _c)	48 V
Max. continuous operating voltage (d.c.) pair-pair (PoE) (U _c)	57 V
Nominal current (I _n)	1 A
D1 Lightning impulse current (10/350 μs) per line (I _{imp})	0.5 kA
C2 Total nominal discharge current (8/20 μs) line-PG (I _n)	10 kA
Cut-off frequency (f _c)	250 MHz
Connection (input / output)	RJ45 socket / RJ45 socket
Approvals	CSA, UL, GHMT, EAC

DEHNpatch Class D

Universal arrester according to class D up to 100 MHz for Ethernet and PoE applications. DIN rail mounted shielded adapter type with sockets.

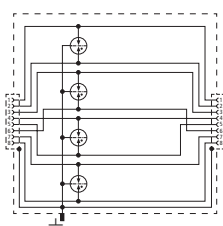

Type DPA ...	M CLD RJ45B 48
Part No.	929 126
SPD class	TYPE 2 P2
Max. continuous operating voltage (d.c.) (U _c)	48 V
Max. continuous operating voltage (d.c.) pair-pair (PoE) (U _c)	57 V
Nominal current (I _n)	1 A
D1 Lightning impulse current (10/350 μs) per line (I _{imp})	0.5 kA
C2 Total nominal discharge current (8/20 μs) line-PG (I _n)	10 kA
Cut-off frequency (f _c)	100 MHz
Connection (input / output)	RJ45 socket / RJ45 socket
Approvals	UL, EAC

SPDs for Tel. and Data Networks

Accessories for DEHNpatch DPA CLE IP66

Lightning Protection Pipe Clamp With Tines

Fixing on elements of any cross-section with clamping screw (M8).

Type	BRS 27.168 Z AK1X10 2X6.8 V2A
Part No.	540 200
Clamping range Ø pipe	27-168 mm (3/4-6")
Material (conductor holder)	StSt
Connection Rd	1-2 x 6-8 mm / 1 x 10 mm
Connection (solid / stranded)	4-50 mm ²



Tensioning Strap for Pole Mounting

Fixing on elements of any cross-section with clamping screw (M8).

Type	LH 6.8 SB50.150 SPSM8 V2A
Part No.	200 039
Clamping range Ø pipe	50-150 mm
Material (conductor holder)	StSt



Accessories for DEHNpatch

Mounting Set for DEHNpatch

The set comprises a DIN rail for up to 24 DEHNpatch devices and different distance bolts with sliding nuts for installation into data distributors. To save space, the DIN rail can be mounted at the distributor panel or even upstream of the mounting sections in a 19" grid dimension.

Type	MS DPA
Part No.	929 199
Mounting in	19" cabinets



482.6 mm (19 inch) Universal DIN Rail Carrier

For 19" technology (3 rack units) or wall mounting. DIN rail can be mounted vertically or horizontally.

Type	MF DR 3RU 19"
Part No.	929 335
Dimensions	3 vertical modules
Enclosure material	aluminium/zinc sheet / StSt

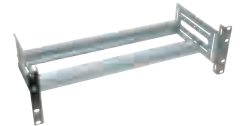

Mounting Kit DEHNpatch and DEHNgate

DIN rail mounting kit for DEHNpatch and DEHNgate. For individual installation of the arresters .

Type	MS EB DPA DGA
Part No.	929 200 ^{NEW}
Material (earthing clip)	St/gal Zn
Material (flat receptable)	CuZn / Sn
Connection cross-section	0.5-1.5 mm ²



SPDs for Tel. and Data Networks



NET Protector



The 482.6 mm (19 inch) enclosure can be equipped with surge protection components for protecting network components (class D) or telecommunications systems.

- Protects switches, hubs and telecommunications systems against overvoltage
- Allows class D networks to be established according to EN 50173 (Gigabit Ethernet)
- Patch panels can be flexibly equipped
- Retrofit versions with plug-in inputs and outputs

The 482.6 mm (19 inch) enclosure can be equipped with up to three surge protection components to protect active network components such as hubs, switches (class D) or telecommunication systems. NET Protector is typically used for Ethernet, Token Ring, E1 and telephone systems.

It only requires the space of one rack unit and is generally installed in terminal boards. It is inserted as a patch panel with surge protection or as a retrofit version for patching between the patch panel and the device to be protected.

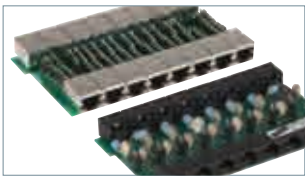

Surge protection components for protecting 8 channels.

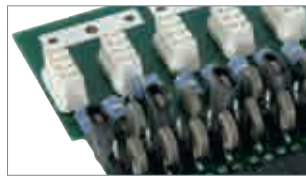

Version with LSA connection for use as patch panel version in new installations.



Retrofit version with RJ45 connection for existing installations.



Version with RJ45 sockets shielded on both ends.

SPDs for Tel. and Data Networks



NET PRO 4TP

Surge protection component with eight shielded ports for universal cabling systems (class D). Retrofit or patch panel version (LSA).

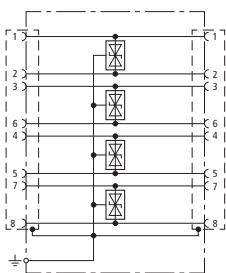

Type NET PRO ...	4TP	4TP 30
Part No.	929 035 [1]	929 037 [1]
SPD class	TYPE 3 P1	TYPE 4 P1
Max. continuous operating voltage (d.c.) (U _c)	6 V	30 V
Nominal current (I _n)	100 mA	100 mA
C2 Nominal discharge current (8/20 μs) per port (I _n)	2.4 kA	0.8 kA
Cut-off frequency line-line at 100 ohms (f _G)	165 MHz	300 MHz
Approvals	EAC	EAC

NET PRO TC

Surge protection component with eight ports for telecommunications systems. Retrofit or patch panel version (LSA).

Type NET PRO ...	TC 2	TC 2 LSA
Part No.	929 071	929 072
SPD class		
Max. continuous operating voltage (d.c.) (U_c)	170 V	170 V
Nominal current (I_L)	150 mA	150 mA
D1 Lightning impulse current (10/350 μ s) per line (I_{imp})	1 kA	1 kA
C2 Nominal discharge current (8/20 μ s) per port (I_n)	10 kA	20 kA
Series resistance per line	10 ohms	10 ohms
Cut-off frequency line-line (f_G)	10 MHz	10 MHz
Approvals	EAC	EAC

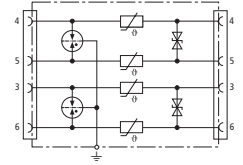

NET PRO 10X TC1 RST

Surge protection component with ten ports for protecting telecommunications systems with analogue or system transmission technology from overvoltage and a.c. interference. Cage spring terminals which can be removed from the protection component as a block are situated on the input side, thus allowing to test the lines. For installation into EG NET PRO 10X 19" or EG NET PRO 10X 3HE enclosures.

Type NET PRO ...	10X TC1 RST
Part No.	929 230
SPD class	
Max. continuous operating voltage (d.c.) (U_c)	180 V
Nominal current at 20 °C / 50 °C / 70 °C (I_L)	120 mA / 100 mA / 60 mA
D1 Lightning impulse current (10/350 μ s) per line (I_{imp})	1 kA
C2 Nominal discharge current (8/20 μ s) per port (I_n)	10 kA
Series resistance per line	3-12 ohms
Cut-off frequency at 100 ohms (f_G)	55 MHz
Approvals	EAC

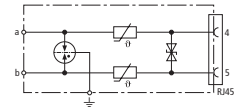

Accessories for NET Protector – Arrester for Data and Telecommunication Systems

482.6 mm (19 inch) Enclosure

Fully shielded empty enclosure for max. three NET Protector protection components.

Type	EG NET PRO 19"
Part No.	929 034
Dimensions	1 rack unit
Enclosure material	stainless steel front / galvanised sheet metal



482.6 mm (19 inch) Enclosure, unshielded

Unshielded 19 inch enclosure (one rack unit) for max. five NET PRO 10X modules, with two earth terminals and cable rail.

Accessories: two nuts, two flat washers and two toothed lock washers for installing the earth terminal.





Type	EG NET PRO 10X 19"
Part No.	929 234
Dimensions	1 rack unit
Enclosure material	StSt (V2A)





DEHN protects.®

SPDs for Building Systems

Product	Description	Type	Part No.	Page
DEHNprotector				
	<ul style="list-style-type: none"> – Combined adapter for protecting the power and data side of a terminal device – Different versions for protecting different interfaces – With visual operating state / fault indication 	DPRO 230 TV DPRO 230 NT DPRO 230 ISDN DPRO 230 LAN100	909 300 909 310 ! 909 320 909 321	210 211 211 211
BUStector				
	<ul style="list-style-type: none"> – Surge arrester for protecting KNX/EIB systems – Optimally adapted to KNX/EIB systems – EIBA-approved 	BT 24	925 001	212
DEHNbox				
	<ul style="list-style-type: none"> – Wall-mounted universal lightning current and surge arrester – Integrated actiVsense technology – Easy installation and retrofitting 	DBX TC 180 DBX U4 KT BD 0-180 DBX U2 KT BD 0-180	922 210 922 400 ! 922 200	214 214 214
DEHNlink				
	<ul style="list-style-type: none"> – Wall-mounted surge arrester for protecting telecommunication interfaces – With operating state indication of the remote supply voltage – Easy installation and retrofitting 	DLI ISDN I	! 929 024	215



DEHNprotector



Combined surge protective adapter with visual operating state and fault indication plugged into an earthed socket outlet.

- Combined surge protection for the power and data side of terminal equipment
- Protection of
 - TVs and satellite devices
 - ISDN and telephone systems
 - Ethernet components
- Visual operating state / fault indication
- Easy retrofitting

The arresters of the DEHNprotector family are plugged into earthed socket outlets and protect terminal equipment with an additional data interface. Surges are discharged to the PE contact of the socket outlet. The

plug-in installation facilitates retrofitting of surge protection. The surge protective device for the power side features a visual operating state and fault indication, thus ensuring easy maintenance.



Type with coaxial connection.



Type with RJ connection.



Plug for earthed socket outlets for protecting the power side.



Visual operating state and fault indication of the power side (230 V).

For further surge protective adapters for protecting the power supply of electronic devices please also refer to page 117.

DPRO 230 TV

Combined surge protection for the power and antenna side of TV, radio or satellite receivers. With visual operating state and fault indication and integrated child lock.



Type DPRO 230 ...	TV
Part No.	909 300
Protection of the data side	
SPD class	TYPE 2
Max. continuous operating voltage (d.c.) (U _c)	60 V
C2 Nominal discharge current (8/20 μs) line-shield (PE) (I _n)	5 kA
Insertion loss 0-2400 MHz	≤ 1.5 dB
Connection (input / output)	F socket / F socket
Protection of the power side	
SPD according to EN 61643-11 / IEC 61643-11	type 3 / class III
Max. continuous operating voltage (a.c.) (U _c)	255 V (50 / 60 Hz)
Total discharge current (8/20 μs) [L+N-PE] (I _{total})	5 kA
Voltage protection level [L-N] (U _p)	≤ 1.25 kV
Max. mains-side overcurrent protection	16 A gL/gG or B 16 A

DPRO 230 NT

Combined surge protection for the power and data side of a digital network termination (NT). Also suited for telephones and fax machines. With visual operating state and fault indication and integrated child lock.

Type DPRO 230 ...	NT
Part No.	909 310
Protection of the data side	
SPD class	TYPE 2+P1
Max. continuous operating voltage (d.c.) (U_c)	180 V
Lightning impulse current (10/350 μ s) per line D1 (I_{imp})	1 kA
C2 Nominal discharge current (8/20 μ s) per line (I_n)	2.5 kA
Cut-off frequency (f_c)	50 MHz
Connection (input / output)	RJ12 socket / RJ12 socket
Protection of the power side	
SPD according to EN 61643-11 / IEC 61643-11	type 3 / class III
Max. continuous operating voltage (a.c.) (U_c)	255 V (50 / 60 Hz)
Total discharge current (8/20 μ s) [L+N-PE] (I_{total})	5 kA
Voltage protection level [L-N] (U_p)	≤ 1.25 kV
Max. mains-side overcurrent protection	B 16 A



DPRO 230 ISDN

Combined surge protection for the power and ISDN S_0 side of ISDN systems and devices. Shielded port allows to protect Ethernet 10 BT. With visual operating state and fault indication and integrated child lock.

Type DPRO 230 ...	ISDN
Part No.	909 320 
Protection of the data side	
SPD class	TYPE 2+P1
Max. continuous operating voltage (d.c.) (U_c)	48 V
Lightning impulse current (10/350 μ s) per line D1 (I_{imp})	1 kA
C2 Total nominal discharge current (8/20 μ s) (I_n)	10 kA
Cut-off frequency (f_c)	50 MHz
Connection (input / output)	shielded RJ45 socket / shielded RJ45 socket
Protection of the power side	
SPD according to EN 61643-11 / IEC 61643-11	type 3 / class III
Max. continuous operating voltage (a.c.) (U_c)	255 V (50 / 60 Hz)
Total discharge current (8/20 μ s) [L+N-PE] (I_{total})	5 kA
Voltage protection level [L-N] (U_p)	≤ 1.25 kV
Max. mains-side overcurrent protection	B 16 A



DPRO 230 LAN100

Combined surge protection for the power side and data input for protecting LAN components. Protection of all pairs for Ethernet pin assignment. It meets the requirements for channel class D in accordance with EN 50173 and is thus suitable for 1000 Base-T (Gigabit Ethernet). With visual operating state and fault indication and integrated child lock.

Type DPRO 230 ...	LAN100
Part No.	909 321
Protection of the data side	
SPD class	TYPE 2+P1
Max. continuous operating voltage (d.c.) (U_c)	58 V
Lightning impulse current (10/350 μ s) per line D1 (I_{imp})	1 kA
C2 Total nominal discharge current (8/20 μ s) (I_n)	10 kA
Cut-off frequency (f_c)	120 MHz
Connection (input / output)	shielded RJ45 socket / shielded RJ45 socket
Protection of the power side	
SPD according to EN 61643-11 / IEC 61643-11	type 3 / class III
Max. continuous operating voltage (a.c.) (U_c)	255 V (50 / 60 Hz)
Total discharge current (8/20 μ s) [L+N-PE] (I_{total})	5 kA
Voltage protection level [L-N] (U_p)	≤ 1.25 kV
Max. mains-side overcurrent protection	B 16 A





BUSstector



Surge arrester for KNX / EIB buses with connection wires.

- Surge arrester for KNX / EIB buses
- Extremely space-saving due to KNX / EIB bus terminal design
- System-tested with EIBA certification



The discharge capacity, protective effect and mechanical design of BUSstector surge arresters are adapted to the installation environment of KNX / EIB buses. Like a bus terminal, they can be plugged onto the bus terminal pins of a terminal device and can be connected by means of the

existing connecting cables. BUSstector surge arresters can also be connected to an existing bus terminal on the terminal device. They particularly protect line and area couplers as well as gateways and sensors installed at the outer walls of buildings.



Protection of a KNX power supply unit by means of a BUSstector surge arrester mounted in the bus terminal slot.



Protection of a KNX bus coupling unit by means of a BUSstector surge arrester mounted on a bus terminal in the mounting panel of a cable duct.

SPDs for Building Systems

BT

Surge arrester with KNX bus terminal design, adapted to the immunity of KNX/EIB systems. EIBA-certified.



Type	BT 24
Part No.	925 001
SPD class	TYPE 2
Max. continuous operating voltage (d.c.) (U _c)	45 V
Nominal current (I _n)	6 A
D1 Lightning impulse current (10/350 μs) per line	1 kA
C2 Nominal discharge current per line (I _n)	5 kA
Cut-off frequency line-line (f _c)	70 MHz
Approvals	EIBA certification No. Z 32/1399/95, EAC



DEHNbox

- **Combined lightning current and surge arrester**
 - Capable of carrying lightning currents up to 10 kA (10/350 μ s)
 - Low voltage protection level, capable of protecting terminal equipment
 - For installation in conformity with the lightning protection zone concept at the boundaries from $0_A - 2$ and higher
- **Easy to use**
 - Suitable for wall mounting, IP 65 degree of protection
 - Fast and easy installation due to spring-loaded terminals
 - Easy retrofitting of surge protection



DEHNbox used for a telecommunication connection (example: U_{k0} interface)

The compact arresters of the DEHNbox product family are combined lightning current and surge arresters designed for protecting information, measuring and control and automation equipment and systems. With its surface-mounted plastic enclosure with integrated fixing lugs, DEHNbox is ideally suited for wall mounting and can be easily retrofitted into existing equipment and systems. The IP 65 degree of protection allows the arrester to be used in harsh environments such as in moist atmospheres. The conductors are therefore entered via easy-to-install self-sealing rubber grommets. These grommets allow easy and fast installation and prevent the ingress of moisture and dust. Both the cores and an installed line shield can be contacted by means of spring-loaded terminals without the use of screws. DEHNbox is available in two versions:

DEHNbox TC 180

The arrester is optimised for use at telecommunication connections and devices such as analogue telephones as well as ISDN and VDSL2 connections. With a cut-off frequency of 250 MHz, the arrester is also capable of transmitting high-frequency signal parts and can thus be used at high-performance signal interfaces. As an alternative, DEHNbox TC 180 can also be installed at measuring and control interfaces up to a voltage of 180 V and a maximum current of 750 mA.

DEHNbox TC 180 allows fast connection of one pair without tools and fixing of the connecting cable (integrated strain relief) on the printed circuit board by means of cable ties. The connection space in the box and the position of the terminals ensure optimal conductor routing and easy conductor connection.

DEHNbox with actiVsense technology

This arrester type does not have a specific nominal voltage and can thus be used for voltages ranging from 0 to 180 V with a superimposed signal voltage (± 5 V/50 MHz). The nominal current is limited to 100 mA which is sufficient for information technology systems. This innovative actiVsense technology allows the arrester to detect the signal voltage applied and to automatically adapt the voltage protection level to this voltage. This makes the arrester ideal for applications where changing or slowly fluctuating signal levels (≤ 400 Hz) are to be expected. In case of interference, DEHNbox arresters have an adapted voltage protection level for every signal voltage, thus providing maximum protection for the devices and system circuits connected to them. The four-pole version of DEHNbox provides protection for two different balanced interfaces, e.g. a bus interface with a system voltage of 5 V and an analogue measured value signal with a system voltage of 24 V.

The arrester is ideally suited for domestic and industrial use in information technology transmission systems such as telecommunication, bus and measuring and control systems.



Cable entry with self-sealing rubber grommets.

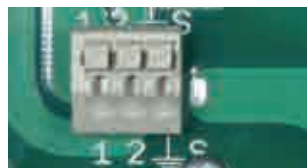

Conductor terminals for fast connection without tools (DBX TC 180).



Conductor fixing by means of cable ties (DBX TC 180).



Available with direct or indirect shield earthing (DBX U4 KT BD S 0-180).

DBX TC 180

Compact combined arrester in a surface-mounted plastic enclosure for protecting information technology interfaces, particularly telecommunication connections and devices such as analogue telephones, ISDN and xDSL (VDSL2-tested). Fast connection of one pair without tools and integrated strain relief for the connecting cable. Cut-off frequency up to 250 MHz ensures maximum transmission performance in case of high-frequency signal parts.

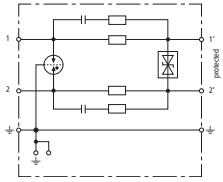

Type DBX ...	TC 180
Part No.	922 210
SPD class	TYPE 1P2
Max. continuous operating voltage (d.c.) (U_c)	180 V
Nominal current at 45°C (I_l)	0.75 A
D1 Total lightning impulse current (10/350 μ s) (I_{imp})	7.5 kA
C2 Total nominal discharge current (8/20 μ s) (I_n)	15 kA
Series resistance per line	1.8 ohms
Bandwidth line-line (100 ohms) (f_G)	250 MHz
Dimensions (L x W x H)	93 x 93 x 55 mm

DBX U4 KT BD S 0-180

Compact combined lightning current and surge arrester in a surface-mounted plastic enclosure with actiVsense technology for protecting two pairs with the same or a different signal voltage of galvanically isolated balanced interfaces. The actiVsense technology automatically detects the operating voltage and optimally adapts the voltage protection level to it.

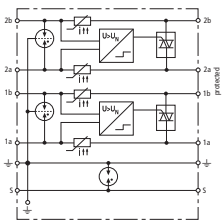

Type DBX ...	U4 KT BD S 0-180
Part No.	922 400
SPD class	TYPE 1P1
Max. continuous operating voltage (d.c.) (U_c)	180 V
Permissible superimposed signal voltage (U_{signal})	$\leq \pm 5$ V
Cut-off frequency line-line (U_{signal} , balanced 100 ohms) (f_G)	50 MHz
Nominal current I_l (equals max. short-circuit current)	100 mA
D1 Total lightning impulse current (10/350 μ s) (I_{imp})	10 kA
C2 Total nominal discharge current (8/20 μ s) (I_n)	20 kA
Series resistance per line	≤ 9 ohms; typically 7.9 ohms
Dimensions (L x W x H)	93 x 93 x 55 mm
Approvals	EAC



DBX U2 KT BD S 0-180

Compact combined lightning current and surge arrester in a surface-mounted plastic enclosure with actiVsense technology for protecting one pair of galvanically isolated balanced interfaces. The actiVsense technology automatically detects the operating voltage and optimally adapts the voltage protection level to it.

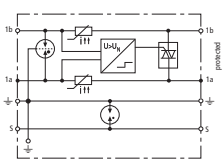

Type DBX ...	U2 KT BD S 0-180
Part No.	922 200
SPD class	TYPE 1P1
Max. continuous operating voltage (d.c.) (U_c)	180 V
Permissible superimposed signal voltage (U_{signal})	$\leq \pm 5$ V
Cut-off frequency line-line (U_{signal} , balanced 100 ohms) (f_G)	50 MHz
Nominal current I_l (equals max. short-circuit current)	100 mA
D1 Total lightning impulse current (10/350 μ s) (I_{imp})	9 kA
C2 Total nominal discharge current (8/20 μ s) (I_n)	20 kA
Series resistance per line	≤ 9 ohms; typically 7.9 ohms
Dimensions (L x W x H)	93 x 93 x 55 mm
Approvals	EAC

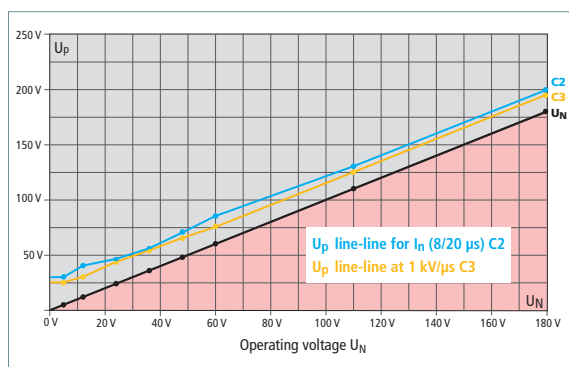

Voltage protection level diagram (DBX U4 KT BD S 0-180)



DEHNlink

- Surface-mounted surge protective device for telecommunications systems
- Quick installation due to plug-in terminals
- Different interface-specific types

The surface-mounted surge arresters with a modern design particularly protect modems and telephone systems with RJ plugs. The plug-in terminals allow easy installation.



Surface-mounted surge arrester for telecommunications terminal equipment as well as telephone systems with RJ plug.



Easy and fast installation by means of RJ plug-in system.

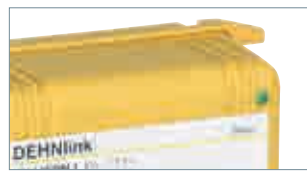

DLI ISDN I devices feature an LED display that indicates the supply voltage.



DLI ISDN I is capable of protecting two terminal devices at the same time.



Fixing lugs on the enclosure allow easy and fast wall mounting.

DLI ISDN I

Energy-coordinated surge arrester with two protected ISDN S_0 outputs and operating state indication (LED). Connecting cable and mounting material included.

Type DLI ...	ISDN I
Part No.	929 024 □
SPD class	TYPE 2P1
Max. continuous operating voltage (d.c.) (U_c)	7.5 V
Max. continuous operating voltage (d.c.) pair-pair (U_c)	45 V
Nominal current (I_n)	200 mA
D1 Lightning impulse current (10/350 μ s) per line (I_{imp})	1 kA
C2 Total nominal discharge current (8/20 μ s) (I_n)	10 kA
Cut-off frequency line-line (f_c)	2 MHz
Connection (input / output)	RJ45 / 2 x RJ45
Approvals	EAC

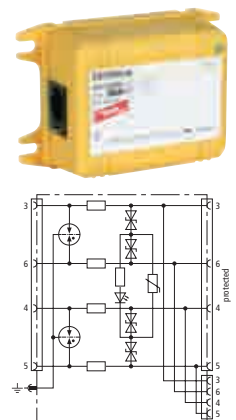



DEHN protects.®

SPDs for Coaxial Connection

Product	Description	Type	Part No.	Page
UGKF BNC				
	<ul style="list-style-type: none"> – Easily adaptable – With indirect shield earthing to avoid leakage pickups – Protection of video cameras 	UGKF BNC	929 010	218
DEHNgate BNC VC				
	<ul style="list-style-type: none"> – Easily adaptable – For DIN rail or wall mounting – With direct or indirect shield earthing 	DGA BNC VCD DGA BNC VCID	909 710 909 711	218 218
DEHNgate FF / GF / GFF TV				
	<ul style="list-style-type: none"> – Combinable system of lightning current and surge arresters – With F connection for 75-ohm satellite and broadband cable systems – Integrated measuring output 	DGA FF TV DGA GF TV DGA GFF TV	909 703 909 704 909 705	219 219 219
DEHNgate 5X FF TV				
	<ul style="list-style-type: none"> – Compact surge arrester for satellite systems – Optimal five-channel protection for 75 Ohm antenna splitters and multi-switches – Fulfills the shielding requirements of class A acc. to EN 50083-2. 	DGA FF5 TV	909 706	220
DEHNgate F				
	<ul style="list-style-type: none"> – Easy to retrofit – For high transmission rates – With 1.6/5.6 connection 	DGA F 1.6 5.6	 929 040	220
DEHNgate G				
	<ul style="list-style-type: none"> – Compact dimensions – Wide transmission range – With SMA, BNC or N connection 	DGA G SMA DGA G BNC DGA G N	929 039 929 042 929 044	220 220 220
DEHNgate AG				
	<ul style="list-style-type: none"> – Exchangeable gas discharge tube – Long endurance 	DGA AG BNC DGA AG N	929 043 929 045	220 220
DEHNgate LG / L4				
	<ul style="list-style-type: none"> – Wide transmission range for multi-frequency applications – Integrated quarterwave technology – With 7/16 or N connection 	DGA LG 7 16 MFA DGA L4 7 16 S DGA L4 7 16 MFA	929 146 929 047 929 148	221 221 221



UGKF



- Plug-in surge protective adapter for easy retrofitting
- Directly plugs into coaxial terminal equipment
- Integrated indirect shield earthing avoids leakage pickups

Surge arrester designed as cable adapter for protecting coaxial systems such as video and camera systems from potential damage.

UGKF BNC shielded surge arresters are plugged into coaxial terminal equipment or connections. Common applications include the protection of outdoor video surveillance systems or video control centres. In order to avoid being effected by leakage pickups, the cable shield is earthed indirectly via a gas discharge tube. The arrester entries are used as sockets and the protected outputs as plugs.

Devices for video systems with a higher supply voltage or sockets on both ends are available on request.

We recommend to use DGA BNC VC... arresters for easy installation on a DIN rail. These space-saving surge arresters have BNC sockets and protect video and camera systems. Two versions are available: DGA BNC VCD with direct connection of the cable shield to the earth potential or DGA BNC VCID with indirect connection of the cable shield. The arresters are earthed via the DIN rail.



UGKF BNC can be directly plugged into the interfaces of terminal equipment.



UL listing for country-specific use.



DGA BNC VC ... can be easily adapted due to BNC connection.



DGA BNC VC... can be easily mounted on DIN rails or walls.

UGKF BNC

Two-stage surge arrester with indirect shield earthing for protecting video cameras and Arcnet with BNC connection to avoid leakage pickups.



Type	UGKF BNC
Part No.	929 010
SPD class	TYPE 2 P1
Max. continuous operating voltage (d.c.) (U _c)	8 V
Nominal current (I _n)	0.1 A
C2 Nominal discharge current (8/20 μs) line-shield (I _n)	2.5 kA
Insertion loss at 300 MHz (50 ohms)	≤ 3 dB
Return loss at 40 MHz (50 ohms)	≥ 20 dB
Insertion loss at 265 MHz (75 ohms)	≤ 3 dB
Return loss at 40 MHz (75 ohms)	≥ 20 dB
Approvals	CSA, UL, EAC

DGA BNC VC

The space-saving surge arrester with BNC socket can be mounted on DIN rails for protecting video and camera systems. Available with direct (VCD) or indirect shield connection (VCID) depending on the type to avoid ground loops.



Type DGA ...	BNC VCD	BNC VCID
Part No.	909 710	909 711
SPD class	TYPE 2 P1	TYPE 2 P1
Max. continuous operating voltage (d.c.) (U _c)	6.4 V	6.4 V
Nominal current (I _n)	0.1 A	0.1 A
D1 Lightning impulse current (10/350 μs) (I _{imp})	1 kA	1 kA
C2 Nominal discharge current (8/20 μs) line-shield (I _n)	5 kA	5 kA
Frequency range	0-300 MHz	0-300 MHz
Connection (input / output)	BNC socket / BNC socket	BNC socket / BNC socket
Approvals	CSA, UL	CSA, UL



DEHNgate

- Universal surge and combined arresters
- Maximum discharge capacity for coaxial systems
- Low voltage protection level allows to protect terminal equipment
- Contact materials with extremely long endurance



DEHNgate is a family of lightning current / surge arresters designed as a cable adapter for protecting coaxial systems such as cell sites and antenna systems from potential damage. The DEHNgate arrester family comes in different mechanical and electrical designs to suit a wide range of applications, with the various types and arrester technologies providing optimal solutions.

The space-saving DG A FF TV can be mounted onto a DIN rail to protect satellite systems with several outputs. For single applications such as broadband cable connections, the device can be simply snapped into a wall-mounted adapter. Two F connections are also included.

The quarter-wave surge arresters are bandpass filters. Only signals within a defined frequency band are transmitted. Since lightning interferences have a low frequency spectrum, the shorting stub acts as a short-circuit, conducting the lightning current to the ground. This makes the surge arresters mechanically very robust and almost maintenance-free. Due to their low voltage protection level and high discharge capacity, they can be used as combined lightning current and surge arresters. If additional remote supply is needed for the antenna, a combination of a gas discharge tube and quarter-wave technology (DGA LG) should be used. The arresters are made of top-quality materials and give outstanding endurance.



Surge arrester for satellite and broadband cable systems.



F connection for 75-ohm systems.



Coaxial arrester with exchangeable gas capsule.



Maintenance-free quarter-wave surge arresters for protecting high-frequency applications (e.g. LTE).

DGA TV

DGA ... TV arresters with F connection for remote supply protect 75-ohm satellite and broadband cable systems and fulfil the high shielding requirements of class A according to EN 50083-2. They allow space-saving installation in all common TV and satellite applications and are available as lightning current arresters, surge arresters as well as combined lightning current and surge arresters with integrated measuring output, allowing the system to be easily tested.

Type DGA ...	FF TV	GF TV	GFF TV
Part No.	909 703	909 704	909 705
SPD class	TYPE 3P1	TYPE 1	TYPE 1+ TYPE 3P1
Max. continuous operating voltage (d.c.) (U _c)	24 V	60 V	24 V
Nominal current (I _n)	2 A	2 A	2 A
D1 Lightning impulse current (10/350 μs) (I _{imp})	0.2 kA	2.5 kA	2.5 kA
C2 Nominal discharge current (8/20 μs) (I _n)	1.5 kA	10 kA	10 kA
Frequency range	d.c. / 5-3000 MHz	0-2400 MHz	d.c. / 5-2400 MHz
Connection (input / output)	F socket / F socket	F socket / F plug	F socket / F socket
Approvals	EAC	EAC	EAC



SPDs for Coaxial Connection

DGA FF5 TV

Five-channel surge arrester for 75 Ohm antenna systems. Special design for SAT antenna splitters and multi-switches. The arrester fulfills the shielding requirements of class A acc. to EN 50083-2. For use at the boundaries of zones 0_B – 2. Delivery includes fastening material, EB conductor and F-Connector adapter for mounting the arrester directly on a multi-switch.

NEW



Type DGA ...	FF5 TV
Part No.	909 706 <small>NEW</small>
SPD class	TYPE 2 P1
Max. continuous operating voltage (d.c.) (U _c)	20 V
Nominal current (I _n)	0.4 A
D1 Lightning impulse current (10/350 μs) (I _{imp})	0.5 kA
D1 Total lightning impulse current (10/350 μs) (I _{imp})	2.5 kA
C2 Nominal discharge current (8/20 μs) (I _n)	2.5 kA
C2 Total nominal discharge current (8/20 μs) (I _n)	12.5 kA
Frequency range	47-2200 MHz
Connection (input / output)	F socket / F socket

DGA F

Quickly operating surge arrester for G.703 interfaces with low-capacitance diode matrix for optimised transmission performance. Earthing via enclosure. 1.6/5.6 connection.



Type DGA ...	F 1.6 5.6
Part No.	929 040 <small>!</small>
SPD class	TYPE 3 P1
Max. continuous operating voltage (d.c.) (U _c)	6 V
Nominal current (I _n)	0.25 A
C2 Nominal discharge current (8/20 μs) (I _n)	0.3 kA
Frequency range	0-80 MHz
Connection	1.6/5.6 plug / 1.6/5.6 socket
Approvals	EAC

DGA G

Surge arrester with integrated gas discharge tube. Remote supply possible. SMA, BNC or N connection.



Type DGA ...	G SMA	G BNC	G N
Part No.	929 039	929 042	929 044
SPD class	TYPE 2	TYPE 2	TYPE 2
Max. continuous operating voltage (d.c.) (U _c)	135 V	135 V	135 V
Nominal current (I _n)	2 A	3.5 A	6 A
Max. transmission capacity	60 W	25 W	60 W
D1 Lightning impulse current (10/350 μs) (I _{imp})	1 kA	1 kA	1 kA
C2 Nominal discharge current (8/20 μs) (I _n)	5 kA	5 kA	5 kA
Frequency range	0-5.8 GHz	0-4 GHz	0-5.8 GHz
Connection	SMA socket / SMA plug	BNC socket / BNC plug	N socket / N plug

DGA AG

Lightning current arrester with replaceable gas discharge tube. Remote supply possible. BNC or N connection.

SPDs for Coaxial Connection



Type DGA ...	AG BNC	AG N
Part No.	929 043	929 045
SPD class	TYPE 1	TYPE 1
Max. continuous operating voltage (d.c.) (U _c)	180 V	180 V
Nominal current (I _n)	3.5 A	6 A
Max. transmission capacity	150 W	150 W
D1 Lightning impulse current (10/350 μs) (I _{imp})	5 kA	5 kA
C2 Nominal discharge current (8/20 μs) (I _n)	20 kA	20 kA
Frequency range	0-1 GHz	0-2.5 GHz
Connection	BNC socket / BNC plug	N socket / N plug

DGA LG

Quarterwave lightning current arrester combined with a spark gap for multi-frequency applications (e.g. LTE). Remote supply possible. 7/16 connection.

Type DGA ...	LG 7 16 MFA
Part No.	929 146
SPD class	TYPE 1
Max. continuous operating voltage (d.c.) (U_c)	65 V
Nominal current (I_L)	13 A
Max. transmission capacity	1500 W
D1 Lightning impulse current (10/350 μ s) (I_{imp})	5 kA
C2 Nominal discharge current (8/20 μ s) (I_n)	20 kA
Frequency range	690 MHz-2.7 GHz
Connection	7/16 socket / 7/16 plug



DGA L4

Combined lightning current and surge arrester with maintenance-free quarterwave technology and adapted frequency band. No remote supply possible. 7/16 connection.

Type DGA ...	L4 7 16 S	L4 7 16 MFA
Part No.	929 047	929 148
SPD class	TYPE 1 P1	TYPE 1 P1
Max. continuous operating voltage (d.c.) (U_c)	0 V	0 V
Nominal current (I_L)	0 A	0 A
Max. transmission capacity	3000 W	1500 W
D1 Lightning impulse current (10/350 μ s) (I_{imp})	25 kA	40 kA
C2 Nominal discharge current (8/20 μ s) (I_n)	50 kA	80 kA
Frequency range	380-512 MHz	690 MHz-2.7 GHz
Connection	7/16 socket / 7/16 plug	7/16 socket / 7/16 plug



Accessories for DEHNGate

Mounting Kit DEHNpatch and DEHNGate

DIN rail mounting kit for DEHNpatch and DEHNGate. For individual installation of the arresters .



Type	MS EB DPA DGA
Part No.	929 200 <small>NEW!</small>
Material (earthing clip)	St/gal Zn
Material (flat receptable)	CuZn / Sn
Connection cross-section	0,5-1.5 mm ²

Gas Discharge Tube for DEHNGate

Lightning current carrying replacement gas discharge tube for DEHNGate arresters. High quality with extremely low capacitance.



Type	GDT DGA 90	GDT DGA 230	GDT DGA 470
Part No.	929 497	929 498	929 499
Lightning impulse current carrying capability (10/350 µs)	5 kA	5 kA	5 kA

Cable Lug with Earthing Conductor

Cable lug with highly flexible black copper earthing conductor for earthing DEHNGate arresters (Part Nos. 929 043, 929 044 or 929 045).



Type	EL 16 B17
Part No.	929 096
Colour	black ●
Length	1000 mm

Earthing Block 4xF

Four-pole earthing block with F sockets for equipotential bonding of satellite cable shields or DGA GF TV lightning current arresters.



Type	EB 4 F
Part No.	929 095
D1 Lightning impulse current (10/350 µs)	10 kA

Angled Fixing Plate for DEHNGate

Suitable for installing a DEHNGate arrester (Part Nos. 929 045, 929 146, 929 047, 929 148).



Type	BW90 B11 B5.1 6.5 11 V2A
Part No.	106 310
Material	StSt

Angled Fixing Plate for DEHNGate

Suitable for installing a DEHNGate arrester (Part Nos. 929 043 - 929 045), anti-rotation borehole (Ø16 mm).



Type	BW90 B16 B5.1 6.5 11 V2A
Part No.	106 314
Material	StSt

Angled Fixing Plate for HF Arresters

With three boreholes for three different sizes of DEHNGate, e.g. 1x 929 042 + 1x 929 057 + 1x (929 043, 929 044, 929 045 or 929 059).



Type	BW90 B17 21 16 V2A
Part No.	106 329
Material	StSt

Equipotential Bonding Busbar for industrial Use

Suitable for 3x DEHNGate (Part Nos. 929 045, 929 047, 929 146, 929 148).



Type	PAS I 6AP M10 V2A
Part No.	472 209
Material	StSt

Earthing Conductor, open / closed Cable Lugs

Cable lug 1x open (M8/M10) and 1x closed (M8), can be combined with Part Nos. 106 310, 106 314, 106 329 and 472 209.



Type	EL16 L1.05M 1KSO 8.10 1KSG 8
Part No.	416 411
Colour	black ●
Length	1050 mm



FS

- Surge arrester with SUB-D connection for easy retrofitting
- 9-pole standard connection
- Standard Profibus-DP or V-24 interface



Surge arrester with D-SUB connection (pin / socket version).



SUB-D connection for easy installation.



Direct connection to the device ensures optimal protection.

The surge arresters are available in a shielded enclosure with SUB-D connection (pin / socket version). The UNC threaded screws of the FS surge arresters for protecting terminal equipment can be exchanged as required. The thread is thus situated either on the pin or socket side, depending on the application.

FS 9E PB

Surge arrester for Profibus-DP. 9-pin SUB-D version, pin 6 unprotected for the programming interface.



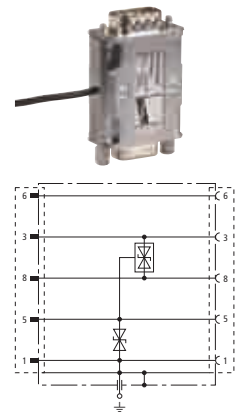



Type FS 9E ...	PB 6
Part No.	924 017
SPD class	TYPE 4 PI
Max. continuous operating voltage (d.c.) (U _c)	7 V
C1 Nominal discharge current (8/20 μs) line-line (I _n)	0.2 kA
C1 Nominal discharge current (8/20 μs) line-SG (I _n)	0.2 kA
C1 Nominal discharge current (8/20 μs) SG-PG (I _n)	0.4 kA
Cut-off frequency (f _c)	90 MHz
Connection (input / output)	SUB-D 9 plug / SUB-D 9 socket
Approvals	EAC





DEHN protects.®

Shield Connection Systems and Enclosures

Product	Description	Type	Part No.	Page
Shield connection on anchor bars				
	<ul style="list-style-type: none"> – Shield terminals for earthing cable shields on anchor bars – Different versions for different cable diameters – Lightning current carrying system 	SAK ... AS V4A	308 403 – 308 408	227
	<ul style="list-style-type: none"> – Mounting rail for earthing and fixing shield terminals – Can be cut to length according to requirements 	AS SAK 1000 V2A	308 421	227
Shield connection on DIN rails				
	<ul style="list-style-type: none"> – Shield terminals for earthing cable shields on DIN rails – Different versions for different cable diameters – Lightning current carrying system 	SAK 6.5 SN MS SAK 11 SN MS	919 010 919 011	228 228
	<ul style="list-style-type: none"> – DIN rail mounted rail support – Low-impedance connection of the shield terminals to the DIN rail via the busbar 	SH1 18X3 ST SH2 18X3 ST	919 012 ! 919 013	228 228
	<ul style="list-style-type: none"> – Busbar for shield terminals – Can be mounted onto busbar supports – Can be cut to length according to requirements 	SN 18X3 CU 1000	919 016	228
Shield connection for cables				
	<ul style="list-style-type: none"> – Constant force spring for solderless shield connection for equipotential bonding – Different versions for different cable diameters – Lightning current carrying system 	SA KRF ... V2A	919 031 – 919 038	229
Enclosure				
	<ul style="list-style-type: none"> – Aluminium enclosure for DIN rail mounted devices – IP 65 degree of protection – Version for arresters for use in intrinsically safe measuring circuits Ex (i) 	ALGA 5 ALGA 5X	906 055 906 058	230 230

Shield Connection on Anchor Bars



Lightning current carrying shield connection system for anchor bars. A slipping spring element compensates the yield of the cable materials used.

The lightning-impulse-current-tested shield connection system is specifically used on anchor bars. As, in the course of time, the cable materials are subject to a yield, this yield is compensated by a slipping spring element. The shield connection can also be isolated from local potential by means of an adequate insulating element.

This extremely robust shield connection system is ideally suited for cables with medium-sized diameters. It is lightning current tested and approved for nuclear plants.

- Lightning-impulse-current-tested up to 10 kA (10/350 μ s)
- Corrosion-resistant stainless steel
- Spring element ensures permanent shield connection



Shield connection system on an anchor bar

Shield Terminals

Shield terminals for earthing cable shields on anchor bars. Suitable for lightning equipotential bonding. Can be subsequently installed without interrupting the cable shield or requiring tools for installation. Approved for use in nuclear plants with TÜV test certificate ETL 10/PB 301/97 (TÜV = German Technical Inspectorate).

General Information:	
Lightning impulse current carrying capability (10/350 µs)	10 kA
Material	StSt
For mounting on	anchor bars
Approvals	ETL 10/PB 301/97

Type	SAK 10 AS V4A	SAK 14 AS V4A	SAK 18 AS V4A
Part No.	308 403	308 404	308 405
Clamping range (Rd)	5-10 mm	8-14 mm	13-18 mm
Dimensions (W x L x H)	16 x 40 x 48 mm	19.5 x 40 x 50 mm	24 x 40 x 56 mm

Type	SAK 21 AS V4A	SAK 26 AS V4A	SAK 33 AS V4A
Part No.	308 406	308 407	308 408
Clamping range (Rd)	17-21 mm	19-26 mm	25-33 mm
Dimensions (W x L x H)	29 x 40 x 59 mm	36.5 x 40 x 74 mm	45 x 40 x 82 mm



Anchor Bar

Mounting rail for earthing and fixing shield terminals.

Type	AS SAK 1000 V2A
Part No.	308 421
Material	StSt
Dimensions (W x L x H)	29 x 1000 x 15 mm
Approvals	ETL 10/PB 301/97

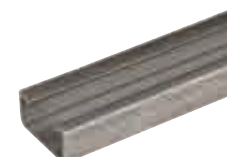

Insulated Busbar Support

Insulated busbar support for fixing AS SAK 1000 V2A anchor bars, with M4 threaded bushing.

Type	ST AS SAK K
Part No.	308 425
Material	plastic
Approvals	ETL 10/PB 301/97



Terminal

For connecting equipotential bonding conductors to AS SAK 1000 V2A anchor bars.

Type	AK 16 AS SAK MS
Part No.	308 411
Cross-sectional area, solid	16 mm ²
For mounting on	anchor bars
Approvals	ETL 10/PB 301/97



Shield Connection on DIN Rails

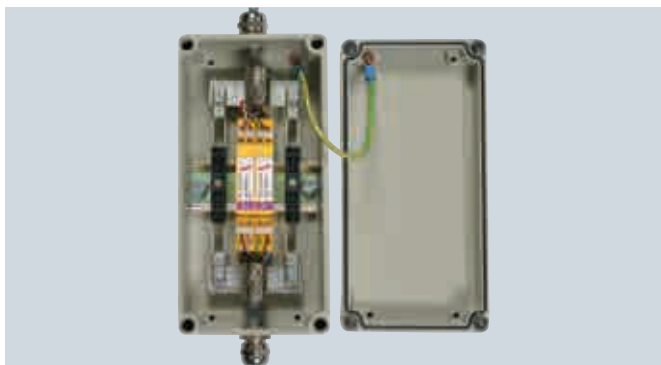

Lightning current carrying DIN rail mounted shield connection system, ideally suited for small cables. Slipping spring element compensates the yield of the cable materials.

- Lightning-impulse-current-tested up to 5 kA (10/350 μs)
- Corrosion-resistant stainless steel
- Spring element ensures permanent shield connection

The lightning-impulse-current-tested DIN rail mounted shield connection system for a wide range of applications is ideally suited for small cable diameters such as bus cables. As, in the course of time, the conductor materials are subject to a yield, this is compensated by a slipping spring element. The shield connection can also be isolated from local potential by means of an adequate insulating element.



Shield Terminals

For DIN rails.

Type	SAK 6.5 SN MS	SAK 11 SN MS
Part No.	919 010	919 011
Lightning impulse current carrying capability (10/350 μs)	5 kA	5 kA
Clamping range (Rd)	1.5-6.5 mm	5-11 mm
Material	nickel-plated brass	nickel-plated brass
For mounting on	SN 18x3 CU 1000	SN 18x3 CU 1000
Dimensions (W x L x H)	10 x 25 x 40 mm	17 x 25 x 47 mm



Busbar

Mounting rail for shield terminals. Can be mounted onto busbar supports.

Type	SN 18X3 CU 1000
Part No.	919 016
Material	tin-plated copper
For mounting on	busbar supports
Dimensions (W x L x H)	18 x 1000 x 3 mm



Rail Support with one-sided / two-sided Contact

Rail support suitable for DIN rail mounting. Low-impedance connection of the shield terminals to the DIN rail via the busbar.

Type	SH1 18X3 ST	SH2 18X3 ST
Part No.	919 012	919 013
Version	one-sided contact	two-sided contact
Material	tin-plated steel	tin-plated steel
For mounting on	35 mm DIN rails acc. to EN 60715	35 mm DIN rails acc. to EN 60715



Insulated Rail Support

Insulated rail support for DIN rail mounting or screw connection.

Type	SH 18X3 K
Part No.	919 014
Material	plastic
Colour	black ●
For mounting on	DIN rails or mounting plates



Terminal

Particularly suited for indirect shield earthing.

Type	AK 35 SN 18X3 GG
Part No.	919 015
Cross-sectional area	35 mm ²
For mounting on	busbars

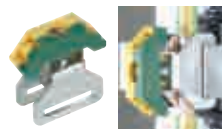



Shield Connection for Cables

- Lightning-impulse-current-tested up to 10 kA (10/350 μs)
- Extremely space-saving
- Spring element ensures permanent shield connection



Extremely space-saving shield connection system for use as constant force spring. A spring element compensates the yield of the cable materials.



Test certificate for constant force spring of type SA KRF ...

The shields of the incoming information and power supply lines can be contacted by means of SA KRF constant force springs in a space-saving and lightning current carrying way. As, in the course of time, the conductor materials are subject to a yield, this yield is compensated by a spring element. To permanently protect the clamping point from corrosion, it is wrapped with a self-bonding SKB rubber tape.

Constant Force Spring

Constant force springs allow solderless shield connections for equipotential bonding or lightning equipotential bonding. They can be installed subsequently without interrupting the cable shield or requiring tools for installation. Approved for nuclear plants according to TÜV Certificate No. T12-04-ETL003 (TÜV = German Technical Inspectorate).

General Information:	
Lightning impulse current carrying capability (10/350 μs)	10 kA
Colour	bare surface
For mounting on	cable shields
Approvals	T12-04-ETL003

Type	SA KRF 10 V2A	SA KRF 15 V2A	SA KRF 22 V2A	SA KRF 29 V2A
Part No.	919 031	919 032	919 033	919 034
Clamping range (Rd)	4-10 mm	9-15 mm	14-22 mm	18.5-29 mm

Type	SA KRF 37 V2A	SA KRF 50 V2A	SA KRF 70 V2A	SA KRF 94 V2A
Part No.	919 035	919 036	919 037	919 038
Clamping range (Rd)	23.5-37 mm	31-50 mm	44-70 mm	58-94 mm



Self-bonding Rubber Tape

Roll with 9 m self-bonding rubber tape to be wrapped around constant force springs for permanent corrosion protection.

Type	SKB 19 9M SW
Part No.	919 030
Colour	black ●
Tape dimensions (W x L)	19 mm x 9 m



Shield Connection Enclosures

Enclosure and Protective Conductor Terminal

- High-quality accessories
- Suitable for DIN rail mounted arresters

**Aluminium Enclosure**

For the installation of DIN rail mounted devices. With two M20 brass glands.

Type	ALGA 5
Part No.	906 055
Degree of protection	IP 65
For mounting on	walls
Dimensions (W x H x D)	100 x 200 x 81 mm
Enclosure material	Al

Aluminium Enclosure for Ex(i) Surge Arresters

With 4 plastic glands M20 x 1.5, sealable, pressure compensating grommets.



Type	ALGA 5 X
Part No.	906 058
Degree of protection	IP 65
For mounting on	walls
Dimensions (W x H x D)	160 x 100 x 85 mm
Enclosure material	Al

Protective Conductor Terminal

For earthing DIN rails.



Type	SLK 16
Part No.	910 099
Cross-sectional area, flexible	6-16 mm ²
Cross-sectional area, solid	6-25 mm ²
For mounting on	DIN rails acc. to EN 60715
Enclosure material	polyamide 6.6



Condition Monitoring System with LifeCheck® Sensor

- Permanent condition monitoring of LifeCheck-equipped arresters ensures a maximum degree of system protection and availability
- The early detection system already detects pre-damaged arresters and warns of imminent arrester failure
 - Visual indication of faulty or pre-damaged arresters
 - Compact dimensions and minimum wiring effort
 - Monitoring of up to ten arresters (40 signal cores)
 - Remote signalling contact
 - Remote monitoring also via RS485 interface and PC software (DRC MCM XT)



Installed DEHNrecord condition monitoring system

Condition monitoring

The DRC MCM XT and DRC SCM XT condition monitoring systems are compact DIN rail mounted devices designed for condition monitoring of up to 10 pre-programmed BXT/BXTU arresters with an integrated LifeCheck monitoring circuit.

Integrated into the protection modules, LifeCheck permanently monitors the condition of the arrester and acts like an early warning system, detecting imminent electrical or thermal overload of the protection components. The LifeCheck status can be read via non-contact RFID technology. Stationary installed, a single condition monitoring unit allows condition-based maintenance of 10 BXT/BXTU arresters.

The unit acts like an early warning system, generating a fault message already in case of imminent arrester overload. This fault message is indicated by an integrated three-coloured LED and transmitted via an integrated remote signalling contact. Failure of the monitoring unit, e.g. due to a voltage breakdown, is also indicated via the remote signalling contact.

The Show function integrated in the DRC MCM XT and DRC SCM XT system allows to detect pre-damaged arresters in the monitoring group.

The DRC SCM XT device is ideally suited for small-sized installations and allows to monitor up to 10 protection modules with integrated LifeCheck. In case of larger installations with more than 10 arresters, the DRC MCM XT device with integrated RS485 interface is used. The condition monitoring units are connected via the integrated RS485 interfaces to synchronise the monitoring cycles. Up to 15 DRC MCM systems can be connected to one another at the RS485 bus, allowing up to 150 BLITZDUCTOR modules or 300 pairs to be monitored simultaneously with minimum wiring effort.

The "Status Display and Service Console" PC software

is optionally available for the DRC MCM XT condition monitoring system. It indicates the status of the arresters and addresses the LifeCheck-equipped BLITZDUCTOR modules.

The software can be installed on a standard PC using an RS485/USB interface converter of type "USB-NANO 485" which is available as accessory.

The software can be downloaded free of charge at www.dehn-international.com (Service section) or is available as CD for a nominal fee.



Integrated visual operating state indication with three-colour LED.



Floating remote signalling contact
DRC MCM XT: break contact (21/22), make contact (13/14)
DRC SCM XT: break contact (21/22)



RS485 interface A/B (only for DRC MCM XT) for communication and control room solutions.



Online monitoring via free software (only for DRC MCM XT).

DRC MCM XT

DIN rail mounted device with integrated LifeCheck sensor for condition monitoring of max. ten LifeCheck-equipped BLITZDUCTOR XT/XTU arresters. Visual operating state indication via three-coloured LED in conjunction with remote signalling contact (break or make contact). The free "Status Display and Service Console" software can be optionally used via an RS485 interface converter. The software allows to remotely indicate the condition of all monitored arresters by means of a PC. Download: www.dehn-international.com (Service section)

Type DRC ...	MCM XT
Part No.	910 695
Input voltage range (d.c.) (U _{IN})	18-48 V
Max. rated current consumption (I _{IN})	100 mA
RFID transmission frequency	125 kHz
Type of remote signalling contact	make (no) and break contact (nc)
Delivery includes	base part, monitoring module, quick guide and labelling system

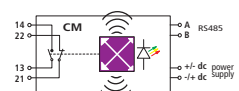



DRC SCM XT

DIN rail mounted device with integrated LifeCheck sensor for condition monitoring of up to ten LifeCheck-equipped BLITZDUCTOR XT/XTU arresters. Visual operating state indication via three-colour LED combined with remote signalling function (break contact).

Type DRC ...	SCM XT
Part No.	910 696
Input voltage range (d.c.) (U_{IN})	18-48 V
Max. rated current consumption (I_{IN})	100 mA
RFID transmission frequency	125 kHz
Type of remote signalling contact	break contact (nc)
Delivery includes	base part, monitoring module, quick guide and labelling system

Accessories for Condition Monitoring System with LifeCheck® Sensor

DIN Rail mounted Power Supply Unit

High-performance DIN rail mounted power supply unit with single-phase wide-range input can be connected to different supply systems. The operating state indicator on the front panel indicates whether the output voltage is present. Up to 10 DRC MCM XT or DRC SCM XT (single application) or up to 15 DRC MCM XT (multiple application) monitoring devices can be connected to a single power supply unit.



Type	PSU DC24 30W
Part No.	910 499
Input voltage range	AC 85-264 V; DC 120-373 V
Frequency	44-66 Hz; 0 Hz
Input current (I_e)	0.7 A at AC 110 V / 0.5 A at AC 230 V
Output nominal voltage (U_a)	DC 24 V (SELV)
Output current (I_a)	1.3 A at DC 24 V, max. 0.9 A at any installation position
Recommended backup fuse	circuit breaker 10 A, 16 A, characteristic B, C
Normen / Bestimmungen	EN 60950, EN 61204-3, UL 60950, UL 508, GL

USB Interface Converter of Type USB-NANO-485

USB-Nano-485 converts between USB and RS485 signals and is specifically designed for two-wire RS-485 buses. LEDs indicate the operating state (yellow), Rx (green) and Tx (red). Due to its compact dimensions, USB-Nano-485 is ideally suited for use with notebooks, however, stationary use is also possible.



Type	USB NANO 485
Part No.	910 486
Version	with LED indication

Labelling System BA1-BA15

2x 165 adhesive labels for labelling DRC MCM XT monitoring devices with the bus address.



Type	BS BA1 BA15 BXT
Part No.	920 398
Colour	transparent

Partition

Allows to position BXT devices for non-intrinsically safe circuits directly next to intrinsically safe circuits (thread measure ≥ 50 mm). For DRC MCM XT and DRC SCM XT; 1 set = 2 pieces.



Type	TW DRC MCM EX
Part No.	910 697
Colour	blue



DEHNrecord Alert

- Modbus TCP/RTU communication module
- Integration of Red/Line and Yellow/Line SPDs into a monitoring system
- Monitoring of up to 4 surge arresters with remote signalling contacts and up to 150 BLITZDUCTOR XT arresters (RS 485)
- Integration of the remote signalling contacts of further user-defined functional modules in the monitoring system



DEHNrecord Alert MODBUS

DEHNrecord Alert is a communication module which integrates Red/Line and Yellow/Line SPDs into a monitoring system. The systems can communicate via serial (Modbus RTU) as well as Ethernet based (Modbus TCP) interface. In case of the Red/Line SPDs the integrated floating remote signalling contacts are recorded. BLITZDUCTOR XT arrester modules are monitored via the DRC MCM AL XT, which transmits the collected information to the DRC AL via an RS 485 interface. In addition to the status of the SPDs also the part number of the complete device and the part numbers of the replacement modules of the Red/Line and Yellow/Line devices are relayed. Sending the relevant data to the customer's monitoring system maintenance of the system can be planned directly on workplace. This facilitates the efficient and cost-effective co-ordination of service and maintenance work, because on evaluation of the status reports the prod-

ucts to be replaced are shown. DEHNrecord Alert autonomously detects all integrated BLITZDUCTOR XT modules and their information. Integration of SPDs with remote signalling contact requires a start-up app. Intuitive to operate, this app relays device information of the connected SPDs per wireless communication to the DEHNrecord Alert. Optionally also the remote signalling contacts of any other function modules can be integrated. In this case only the status of the respective remote signalling contacts is relayed. The module is mounted on DIN rail in the switching cabinet. Versions with further bus protocols can be implemented upon request.

DEHNrecord DRC MCM AL XT

DRC MCM AL XT is a compact DIN rail mounted device for monitoring the status of up to 10 surge arresters of the BXT/BXTU series with integrated LifeCheck. In case of larger installations with more than 10 arresters, up to 15 DRC MCM AL XT can be interconnected by means of the integrated RS 485 interface. Thus, up to 150 protection modules can be monitored simultaneously and the device status can be transmitted to a recording system by a single DEHNrecord Alert.

DRC MCM AL XT is a special version of DRC MCM XT. In addition to the bus address of the BLITZDUCTOR XT the DRC MCM AL XT additionally can read and transmit its article number. Reading of the article number is only possible in connection with the DEHNrecord Alert. The protection modules are directly addressed with the monitoring module or the PC via the "Status Display and Service Console" software. Already installed DRC MCM XT can be adapted for the use of DEHNrecord Alert anytime by a software update.

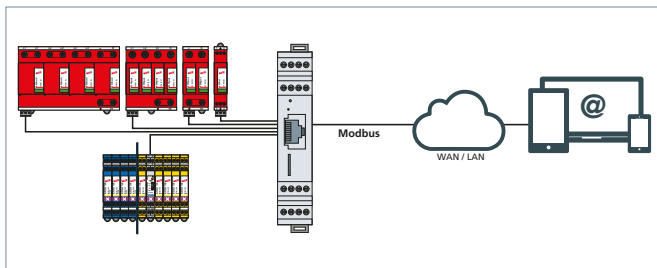

Configuration of the whole DEHNrecord Alert system with Red/Line and Yellow/Line surge arresters.

DRC AL MODBUS

Compact DIN rail mounted device for the transmission of SPD status information, e.g. functional status, part number of SPD and part numbers of the replacement modules via Modbus RTU/TCP.

Type DRC ...	AL MODBUS
Part No.	910 694 ^{NEW}
Input voltage range (d.c.) (U _{IN})	11-28 V
Power max.	600 mW
Inputs	4 universally usable FM contacts and up to 150 BLITZDUCTOR XT via DRC MCM AL XT (910 698)
Communication	Modbus RTU/TCP



DRC MCM AL XT

DIN rail mounted device with integrated LifeCheck sensor for condition monitoring of max. ten LifeCheck-equipped BLITZDUCTOR XT/XTU arresters. Transmission of the status of the bus address and BXT part numbers to the DEHNrecord Alert communication unit.

Type DRC ...	MCM AL XT
Part No.	910 698 ^{NEW}
Input voltage range (d.c.) (U _{IN})	18-48 V
Max. rated current consumption (I _{IN})	100 mA
RFID transmission frequency	125 kHz
Physical interface	RS 485
Delivery includes	base part, monitoring module, quick guide and labelling system

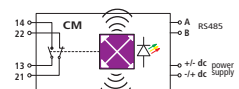



LifeCheck® SPD Test Devices



- SPD test device for preventive maintenance
 - The LifeCheck monitoring device detects thermal or electrical overload conditions of all components
 - To avoid imminent failure and thus system downtime, the protection module should be replaced as soon as possible
- Benefits of this type of SPD testing:
 - Extremely easy and within a matter of seconds
 - Detection of thermal or electrical pre-damage of all components

Maintenance tests and test intervals for lightning protection systems are specified in DIN EN 62305-3, supplement 3 (see table excerpt). However, these periods are only standard-based minimum requirements.

Class of SPD	Visual inspection	Complete inspection	Complete inspection of critical systems
I and II	1 year	2 years	1 year
III and IV	2 years	4 years	1 year

Visual inspections of arresters for information technology systems do not make sense since the status of the devices is not generally visible. For this purpose, another method has to be chosen as is the case with complete inspections. In the past, measurement equipment was used to test arresters. These measurements were very time consuming, required expertise and did not provide sufficient information.

Preventive maintenance:

With this maintenance strategy, arresters are tested and measured at regular intervals. They are assessed according to predetermined criteria and, if required, replaced.

In the past, this procedure was very time consuming, expensive and required disconnection of the system.

LifeCheck-equipped arresters have been available for some years now, allowing to determine the status of the arrester via RFID technology. A monitoring circuit with a transponder integrated the arrester permanently monitors the protective circuit for impermissible overload caused by overheating or impulse currents.

Information is read via a hand-held tester which houses the RFID reader. It contactlessly transmits electromagnetic energy to the transponder in the SPD, reads out its status and displays it. Information is simple: "SPD OK" or "Replace SPD!". A test can be conducted in a matter of seconds. When testing, the arrester must simply be pulled out of the base part by its mechanical length (approx. 50 mm). By using the BXT BAS, signal availability is also guaranteed while testing.

This type of monitoring reliably detects thermal and electrical overload of all components, typically before the arrester fails and the availability of the system to be protected is limited. In addition, no expertise is required for testing. The reader also facilitates documentation of the test results which is mandatory in compliance with the EN 62305-3 standard.

The test data (date, time, results) of all arresters are saved and can be transmitted to a PC via a USB interface for printing or storage. Consequently, a higher degree of protection and availability is achieved by means of LifeCheck-based preventive maintenance since overload of components is already detected before the protection of the system circuit fails.



Intuitive operation and fast arrester testing (M1+).



Hand-held snap-on sensor testing (M1+).



Interval testing with DRC LC M3+.

Test 01		
Status	Interval testing	Interval testing
OK	11:41:54	20.08.18
OK	11:41:54	20.08.18
OK	11:42:12	20.08.18
OK	11:42:30	20.08.18
OK	11:42:54	20.08.18
OK	11:43:10	20.08.18
OK	11:43:29	20.08.18
OK	11:43:50	20.08.18
OK	11:44:08	20.08.18

Database function of DRC LC M3+.

Measuring and Test Devices

DRC LC M3+

Portable device with LifeCheck sensor for flexible use. Fast and easy testing of LifeCheck-equipped arresters. Visual and acoustic indication. With additional USB connection and database software for PC-aided management of test samples and documentation of the test results. The DRC LC M3+ features a snap-on LifeCheck sensor. The hand-held device allows parameterisation of arresters for condition monitoring.

Type DRC LC ...	M3+
Part No.	910 653
Voltage supply (included in delivery)	lithium-ion battery
RFID transmission frequency	125 kHz
Measured value indication	beep and LCD
Delivery includes	hand-held device, BXT LifeCheck sensor, battery charger, USB cable, test module for reference, software CD, storage case
Dimensions of the storage case	340 x 275 x 83 mm



DRC LC M1+

Portable device with LifeCheck sensor for flexible use. Fast and easy testing of LifeCheck-equipped arresters. The result of the LifeCheck test, the operating state of the device and the battery status are indicated via LEDs. The DRC LC M1+ features a snap-on LifeCheck sensor.

Type DRC LC ...	M1+
Part No.	910 655
Voltage supply (included in delivery)	lithium-polymer battery
RFID transmission frequency	125 kHz
Measured value indication	LED
Delivery includes	hand-held device, BXT LifeCheck sensor, power supply unit with country-specific adapters, USB cable, test module for reference, storage case
Dimensions of the storage case	275 x 230 x 83 mm



Accessories for LifeCheck® SPD Test Devices

LifeCheck Sensor for DRC BXT

Snap-on LifeCheck sensor and test module for use as spare part / extension for portable LifeCheck test devices.

Type	LCS DRC BXT
Part No.	910 652
For testing	BLITZDUCTOR XT ML





SPD Test Device



- For routine tests of surge protective devices
- Compact dimensions
- Suitable for mains and battery operation
- Low battery indicator
- Test leads included in delivery
- Shock-proof test adapter available as accessory

For testing the sparkover voltage of surge arresters. The specimen is connected via the included test leads or special test adapters.

The PM 20 SPD test device with integrated sparkover detection is used to test Yellow/Line and Red/Line surge arresters with integrated varistor, Zener diode or gas discharge tube. Both the sparkover performance between the connections of the arresters as well as the continuity can be

tested. The results can be compared to the limit values specified in the instructions for use. In case of deviations, the arrester or protection module must be replaced. A test adapter with a corresponding support makes it easier to test arresters of the BLITZDUCTOR XT / XTU / SP product family.



Indication of the measured sparkover voltage.



The sparkover performance of gas discharge tubes, varistors and Zener diodes can be tested.



Insulated test leads are included in delivery.

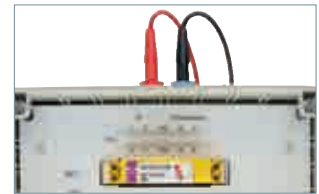

Test adapter for modular arresters.

PM 20

Combined device for testing the sparkover voltage of surge arresters (with gas discharge tubes / varistors / Zener diodes). Storage bag and measuring accessories included.



Type	PM 20
Part No.	910 511
Nominal voltage (d.c.) (U _N)	8-12 V d.c.
Test parameter: Test voltage	max. 1250 V d.c.
Measured value indication	alphanumeric, eight-digit LCD
Accessories included in delivery	2 test leads (each 1 m long), 2 safety tapping test clips, 1 plug-in power supply unit (230 V a.c.), 1 storage bag
Dimensions of the storage bag	300 x 110 x 110 mm

Accessories for SPD Test Device



PA BXT Test Adapter

To be connected to PM 10 / PM 20. For inserting and testing protection modules.

Type	PA BXT
Part No.	910 508
For protection modules	BLITZDUCTOR XT / SP / CT



Are you missing a Yellow/Line Surge Protection Product? Here you will find the relevant successor:

Outdated Part No.	Type	Current Product Part No.	Type
-------------------	------	--------------------------	------

DIN Rail mounted SPDs

918 400	BVT TTY 24	—	
918 407	BVT MTTY 25	—	
918 410	BVT ISDN	—	
920 394	ML BXT M4 T	—	
926 326	BSP M4 BE 60	920 326	BXT ML4 BE 60
926346	BSP M4 BD 60	920 346	BXT ML4 BD 60

SPDs for LSA Technology

907 440	DRL RD 5	907 441	DRL RD 12
---------	----------	---------	-----------

SPDs for Telecommunication and Data Networks

929 024	DLI ISDN I	—	
929 028	DLI TC 2 I	—	
929 034	EG NET PRO 19"	—	
929 035	NET PRO 4TP	929 121 (8x)	DPA M CLE RJ45B 48
929 036	NET PRO LSA 4TP	—	
929 037	NET Pro 4TP 30	929 121 (8x)	DPA M CLE RJ45B 48
929 071	NET PRO TC 2	—	
929 072	NET PRO TC 2 LSA	—	
929 110	DPA M CAT6 RJ45H 48	929 100	DPA M CAT6 RJ45S 48
929 230	NET PRO 10X TC1 RST	—	

Outdated Part No.	Type	Current Product Part No.	Type
-------------------	------	--------------------------	------

Accessories for SPDs for Telecommunication and Data Networks

929 234	EG NET PRO 10X 19"	—	
---------	--------------------	---	--

SPDs for Building Systems

922 200	DBX U2 KT BD S 0-180	922 210	DBX TC 180
929 024	DLI ISDN I	—	
929 028	DLI TC 2 I	—	
909 320	DPRO 230 ISDN	—	

SPDs for coaxial Connection

929 040	DGA F 1.6 5.6	—	
929 046	DGA LG 7 16	929 146	DGA LG 7 16 MFA
929 048	DGA L4 7 16 B	929 148	DGA L4 7 16 MFA
929 057	DGA AG U	—	
929 446	DGA LG 7 16 X	929 146	DGA LG 7 16 MFA

Shield Connection Systems

919 013	SH2 18X3 ST	919 012	SH1 18X3 ST
---------	-------------	---------	-------------



DEHN protects.®

LIGHTNING EQUIPOTENTIAL BONDING

Isolating Spark Gaps and Components





- For indirect connection / earthing of functionally isolated parts of installations under lightning conditions
- For lightning equipotential bonding according to IEC 62305
- With corrosion-resistant stainless steel connections
- For installation in buildings, outdoor locations and damp rooms as well as for underground installation
- Extremely heavy-duty devices

For lightning equipotential bonding according to IEC 62305 as well as for use in IT installations according to IEC 60364-5-54.

TFS: High-capacity isolating spark gap

KFSU: Isolating spark gap

TFS / KFSU

Isolating spark gaps with plastic sheath and two stainless steel connections (Rd 10 mm).



Type	TFS	KFSU
Part No.	923 023	923 021
Isolating spark gap according to EN 62561-3 / IEC 62561-3	yes	yes
Lightning impulse current (10/350 μ s) (I_{imp})	100 kA	—
Class (lightning current carrying capability)	H	—
Rated impulse sparkover voltage ($U_{r imp}$)	≤ 4 kV	≤ 4 kV
Degree of protection protection	IP 65	IP 65



EXFS L / EXFS KU

- For indirect connection / earthing of functionally isolated parts of installations under lightning conditions
- For lightning equipotential bonding according to IEC 62305 in hazardous areas (zone 2)
- Corrosion-resistant zinc die-cast enclosure with plastic cover and flexible cable connection
- For bridging insulating joints, insulating flanges etc. in cathodically protected pipe sections
- Extremely heavy-duty device
- Approval according to ATEX directive 94/9/EC and IECEx



ATEX and IECEx-certified isolating spark gap for lightning equipotential bonding according to IEC 62305 with flexible cable connection.

EXFS L ...: Isolating spark gap for use in hazardous areas with flexible connecting cable

EXFS KU: Isolating spark gap for use in hazardous areas with two 1.5 m long connecting cables for underground installation

Ex isolating spark gaps of the EXFS L / EXFS KU product line are used when electrically conductive parts of installations cannot be directly interconnected in hazardous areas, for example, in case of cathodically protected pipeline sections.

ATEX and IECEx-certified EXFS L and EXFS KU spark gaps provide approved safety in accordance with harmonised European standards.

The arc-resistant tungsten / copper electrodes ensure a long service life of the Ex spark gaps.

The approved EXFS L type with flexible cable connection quickly adapts to any application environment. The prewired spark gaps feature connecting cables of different lengths with cable lug, screw and M10 nut. The flat or angled connection brackets (IF), which are available as accessory, allow to easily connect the spark gap to pipeline flanges.

The EXFS KU type is enclosed by a water-proof PVC sheath and is thus ideally suited for underground installation on insulating couplings.

EXFS L

Ex isolating spark gap for aboveground installation.

Type EXFS ...	L100	L200	L300
Part No.	923 060	923 061	923 062
Isolating spark gap according to EN 62561-3 / IEC 62561-3	yes	yes	yes
Lightning impulse current (10/350 µs) (I_{imp})	50 kA	50 kA	50 kA
Class (lightning current carrying capability)	N	N	N
Rated impulse sparkover voltage ($U_{r imp}$)	≤ 2.5 kV	≤ 2.5 kV	≤ 2.5 kV
Degree of protection	IP 54	IP 54	IP 54
ATEX approvals	DEKRA 11ATEX0146 X	DEKRA 11ATEX0146 X	DEKRA 11ATEX0146 X
Ex marking according to EN 60079-0 and EN 60079-15: gas	II 3 G Ex nC IIC T4 Gc	II 3 G Ex nC IIC T4 Gc	II 3 G Ex nC IIC T4 Gc
IECEx approvals	IECEx DEK 11.0063X	IECEx DEK 11.0063X	IECEx DEK 11.0063X
Ex marking according to EN 60079-0	Ex nC IIC T4 Gc	Ex nC IIC T4 Gc	Ex nC IIC T4 Gc
Cable length	100 mm	200 mm	300 mm



EXFS KU

Ex isolating spark gap with connecting cables for aboveground and underground installation; with water-proof sheath; can be shortened for short cable lengths.

Type EXFS ...	KU
Part No.	923 019
Isolating spark gap according to EN 62561-3 / IEC 62561-3	yes
Lightning impulse current (10/350 µs) (I_{imp})	50 kA
Class (lightning current carrying capability)	N
Rated impulse sparkover voltage ($U_{r imp}$)	≤ 2.5 kV
Degree of protection	IP 67
ATEX approvals	DEKRA 11ATEX0146 X
Ex marking according to EN 60079-0 and EN 60079-15: gas	II 3 G Ex nC IIC T4 Gc
IECEx approvals	IECEx DEK 11.0063X
Ex marking according to EN 60079-0	Ex nC IIC T4 Gc
Cable length	2x approx. 1500 mm





EXFS 100 / EXFS 100 KU



ATEX and IECEx-certified isolating spark gap with a low sparkover voltage for lightning equipotential bonding according to IEC 62305.

- For indirect connection / earthing of functionally isolated parts of installations under lightning conditions
- Device for lightning equipotential bonding according to IEC 62305 in hazardous areas
- For bridging insulating joints, insulating flanges, etc. in cathodically protected pipe sections
- For safe installation in Ex zone 1 (gas) or 21 (dust)
- Extremely low sparkover voltage
- Extremely high alternating current withstand capability
- Approval according to ATEX directive 94/9/EC, IECEx, UL and Inmetro

- EXFS 100: Isolating spark gap for use in hazardous areas with plastic sheath and M10 threaded bushings
- EXFS 100 KU: Isolating spark gap for use in hazardous areas with two 2 m long connecting cables for underground installation

The Ex isolating spark gaps of the EXFS 100 / EXFS 100 KU product family are used when conductive installation parts situated in hazardous areas cannot be directly interconnected. The spark gaps with low sparkover voltage are especially efficient for isolated parts of installations with low insulation strength. No special requirements have to be observed for safe installation in zone 1 (gases) or zone 21 (dusts). With a maximum lightning impulse current of 100 kA (10/350 μ s), EXFS 100 and EXFS 100 KU meet class H requirements (highest lightning current carrying capability class).

The ATEX and IECEx-certified EXFS 100 and EXFS 100 KU spark gaps provide approved safety according to harmonised European standards. For connecting EXFS 100 spark gaps, prewired connecting cables of different lengths are available as accessory. Flat and angled connection brackets (IF) allow to easily connect the spark gaps to pipeline flanges. EXFS 100 KU types are enclosed by a water-proof plastic sheath and are therefore ideally suited for underground installation on insulating couplings.

EXFS 100

Isolating spark gap for use in hazardous areas with plastic sheath and M10 threaded screws.



Type EXFS ...	100
Part No.	923 100
Isolating spark gap according to EN 62561-3 / IEC 62561-3	yes
Lightning impulse current (10/350 μ s) (I_{imp})	100 kA
Class (lightning current carrying capability)	H
Rated impulse sparkover voltage ($U_{r,imp}$)	≤ 1.25 kV
Degree of protection	IP 67
Approvals	UL
ATEX approvals	DEKRA 11ATEX0178 X
Ex marking according to EN 60079-0 and EN 60079-1: gas	II 2 G Ex db IIC T6 Gb
Ex marking according to EN 60079-0 and EN 60079-31: dust	II 2 D Ex tb IIIC T80 °C Db IP 66/67
IECEx approvals	IECEx KEM 09.0051X
Ex marking according to EN 60079-0 and EN 60079-1: gas	Ex db IIC T6 Gb
Ex marking according to EN 60079-0 and EN 60079-31: dust	Ex tb IIIC T80 °C Db IP 66/67
Inmetro approvals	TÜV 17.0698 X
Ex marking according to EN 60079-0 and EN 60079-1: gas	Ex db IIC T6 Gb
Ex marking according to EN 60079-0 and EN 60079-31: dust	Ex tb IIIC T80 °C Db IP 66/67

Isolating Spark Gaps

EXFS 100 KU

Ex isolating spark gap with connecting cable for aboveground and underground installation; with water-proof sheath; can be shortened for short cable lengths.

Type EXFS ...	100 KU
Part No.	923 101
Isolating spark gap according to EN 62561-3 / IEC 62561-3	yes
Lightning impulse current (10/350 µs) (I_{imp})	100 kA
Class (lightning current carrying capability)	H
Rated impulse sparkover voltage ($U_{r imp}$)	≤ 1.25 kV
Degree of protection	IP 67
Approvals	UL
ATEX approvals	DEKRA 11ATEX0178 X
Ex marking according to EN 60079-0 and EN 60079-1: gas	II 2 G Ex d IIC T6 Gb
Ex marking according to EN 60079-0 and EN 60079-31: dust	II 2 D Ex tb IIIC T80 °C Db IP 66/67
IECEx approvals	IECEx KEM 09.0051X
Ex marking according to EN 60079-0 and EN 60079-1: gas	Ex d IIC T6 Gb
Ex marking according to EN 60079-0 and EN 60079-31: dust	Ex tb IIIC T80 °C Db IP 66/67
Inmetro approvals	TÜV 17.0698 X
Ex marking according to EN 60079-0 and EN 60079-1: gas	Ex db IIC T6 Gb
Ex marking according to EN 60079-0 and EN 60079-31: dust	Ex tb IIIC T80 °C Db IP 66/67
Cable length	2x approx. 2000 mm



Accessories for EXFS 100 / EXFS 100 KU

Angled Connection Brackets – IF 1 –

Angled connection bracket for EXFS ...; diameter corresponds to the bolt diameter of the flange joint; material: St/tZn.

Type	AB EXFS IF1 W 11	AB EXFS IF1 W 14	AB EXFS IF1 W 18	AB EXFS IF1 W 22
Part No.	923 311	923 314	923 318	923 322
Borehole diameter d1	11 mm	14 mm	18 mm	22 mm

Type	AB EXFS IF1 W 26	AB EXFS IF1 W 30	AB EXFS IF1 W 33
Part No.	923 326	923 330	923 333
Borehole diameter d1	26 mm	30 mm	33 mm

Type	AB EXFS IF1 W 36	AB EXFS IF1 W 39	AB EXFS IF1 W 42
Part No.	923 336	923 339	923 342
Borehole diameter d1	36 mm	39 mm	42 mm

Type	AB EXFS IF1 W 48	AB EXFS IF1 W 56	AB EXFS IF1 W 62
Part No.	923 348	923 356	923 362
Borehole diameter d1	48 mm	56 mm	62 mm



Flat Connection Brackets – IF 3 –

Flat connection bracket for EXFS ...; diameter corresponds to the bolt diameter of the flange joint; material: St/tZn.

Type	AB EXFS IF3 G 11	AB EXFS IF3 G 14	AB EXFS IF3 G 18	AB EXFS IF3 G 22
Part No.	923 211	923 214	923 218	923 222
Borehole diameter d1	11 mm	14 mm	18 mm	22 mm

Type	AB EXFS IF3 G 26	AB EXFS IF3 G 30	AB EXFS IF3 G 33
Part No.	923 226	923 230	923 233
Borehole diameter d1	26 mm	30 mm	33 mm

Type	AB EXFS IF3 G 36	AB EXFS IF3 G 39	AB EXFS IF3 G 42
Part No.	923 236	923 239	923 242
Borehole diameter d1	36 mm	39 mm	42 mm



EXFS 100: Connecting Cable, Cu, 25 mm²

Connecting cable for EXFS 100; two cable lugs (Ø10.5 mm) made of Cu/gal Sn, screw, nut and spring washer.

Type	AL EXFS L100 KS	AL EXFS L200 KS	AL EXFS L300 KS
Part No.	923 025	923 035	923 045
Cable length	100 mm	200 mm	300 mm





EXFS Coaxial Connection Box



Coaxial connection of the Ex isolating spark gap for protecting buried insulating joints

- Voltage drop across the connecting cable is up to three times lower than in case of a conventional connecting cable
- Version for lightning equipotential bonding according to IEC 62305 in hazardous areas
- For bridging insulating joints in cathodically protected pipe sections of pipelines
- Easy inspection and exchange of the spark gap without excavation work

NAK SN4631: Coaxial connection box with integrated Ex isolating spark gap EXFS 100

The coaxial connection box with integrated Ex isolating spark gap EXFS 100 protects buried insulating joints and flanges, e.g. when bridging insulating joints in cathodically protected pipe sections.

The insulating joint or flange is connected to the coaxial connection box via a coaxial connecting cable, thus achieving an up to three times better protective effect than in case of a conventional connecting cable of comparable length. Consequently, the coaxial connection box has the advantage that the insulation strength of the insulating joint is not exceeded even in case of long connecting cables. Moreover, this solution allows to easily inspect the Ex isolating spark gap EXFS 100, even if it is installed underground.

The coaxial connection box is supplied with all necessary fixing and assembly accessories, thus ensuring easy installation.

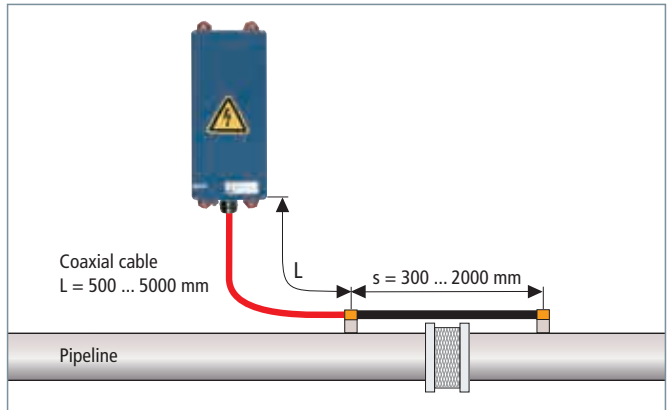

Application example NAK SN4631

Coaxial Connection Box with EXFS 100

Coaxial connection of isolating spark gaps with a low sparkover voltage for lightning equipotential bonding according to IEC 62305.



Type	NAK SN4631
Part No.	999 990
Isolating spark gap acc. to EN 62561-3 / IEC 62561-3	yes
Lightning impulse current (10/350 μ s) (I_{imp})	100 kA
Nominal discharge current (8/20 μ s) (I_n)	100 kA
Rated impulse sparkover voltage ($U_{r,imp}$)	≤ 1.25 kV
Degree of protection protection	IP 67 (UV-resistant)



Voltage-controlled smart decoupling device VCSD

- **VCSD: Voltage Controlled Smart Decoupling Device**
- Protection in case of transient, temporary and long-duration overvoltages
- Does not negatively affect cathodic protection equipment
- Adjustable response threshold for flexible use in a wide range of application and operating states



VCSD 40 IP65: Voltage-controlled smart decoupling device with adjustable response threshold

The smart decoupling device VCSD 40 IP65 is a short-circuiting switch which is controlled by overvoltage and limits long-duration, temporary and transient overvoltages. With the exception of direct currents, the VCSD is capable of discharging all interference voltages and limiting them to a preset value without negatively affecting the d.c. potential (cathodic protection potential). It limits the effects of dangerous high overvoltages in its immediate vicinity to a safe level.

Limiting behaviour of VCSD 40 IP65 in the time range

Transient overvoltages are limited to values < 1.25 kV (time range: up to 1 ms).

Temporary overvoltages are limited to values < 940 V depending on the duration (time range: 1 ms to 200 ms).

Long-duration overvoltages are limited to values between 3 and 50 V a.c. (adjustable) (time range: > 200 ms).

Functional description

Thanks to the coordinated and tested interaction of the functional units within the VCSD, the following overvoltage-related effects can be prevented:

- **Undefined, lightning-related puncture and flashover at insulating clearances**
Lightning-related overvoltage is limited and the associated lightning currents are discharged to local earth.
- **Dangerous touch voltages at accessible places**
Dangerous touch voltages are limited below the maximum permissible touch voltage for the duration of their occurrence.
- **Reduction of a.c. corrosion caused by a.c. interference**
Technical alternating currents between 16.7 Hz and 60 Hz can be permanently discharged to low-impedance earth electrodes without negatively affecting the cathodic protection potential on long-distance pipelines.

Monitoring / controlling

Due to the digital and analogue interfaces, the VCSD 40 IP65 can be externally controlled, device faults can be displayed and discharge currents can be signalled in the form of a 4 – 20 mA signal (scaled to 0 – 40 A).

Fields of application

The VCSD 40 IP65 is ideally suited for pipelines which are interfered by lightning strikes, electric railways or high-voltage lines. Typical fields of application are remote insulated pipeline sections, cathodically protected containers / storage tanks, open earthing of cable shields at accessible places or the corrosion-free interconnection of isolated earth-termination systems such as foundation earth electrodes of a building and an isolated signal ground or railway earth electrode.

Advantages of the VCSD 40 IP65 are the flexible and controllable use in different fields of application, the high discharge capacity as well as a tested, comprehensive, coordinated protection solution from the surge protection specialist DEHN.

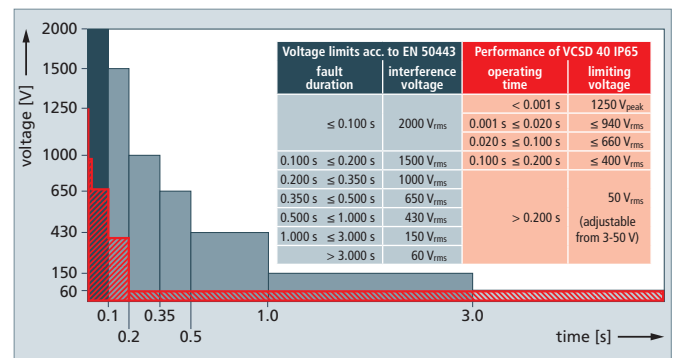

Limiting behaviour of the VCSD

Voltage-controlled smart decoupling device VCSD

VCSD 40 IP65

Voltage-controlled smart decoupling device with adjustable response threshold for flexible use in a wide range of systems.



Type	VCSD 40 IP65
Part No.	923 401
Transient discharge current (10/350 µs)	100 kA
Transient discharge current (8/20 µs)	100 kA
Temporary discharge current (16.7 Hz, 50 Hz, 60 Hz)	1.1 kA _{rms} (up to 200 ms) * ¹⁾
Temporary discharge current (16.7 Hz, 50 Hz, 60 Hz)	500 A _{rms} (up to 1 s)
Long-duration discharge current (16.7 Hz, 50 Hz, 60 Hz)	40 A _{rms} (permanently) * ²⁾
Long-duration limiting voltage (a.c. _{rms}) (> 200 ms)	max. 50 V (adjustable from 3 to 50 V)
Degree of protection	IP 65
Dimensions	400 x 300 x 150 mm

*¹⁾ Derating depends on the „biasing current“ (long-duration discharge current) and on the ambient temperature

*²⁾ Derating depends on the ambient temperature
See instructions for use and installation instructions

Accessories for Voltage-controlled smart decoupling device VCSD

DGP M – 100 kA N-PE Spark-Gap-Based Protection Module

N-PE spark-gap-based protection module for all devices of the modular DEHNgap M family.



Type	DGP M MOD 255
Part No.	961 010
Max. continuous operating voltage (a.c.) (U _c)	255 V



Pipe Clamps for Hazardous Areas Zone 1/21, 2/22

- For use in explosion-hazardous areas Ex zones 1 and 2 (gases, vapours, mists) as well as Ex zones 21 and 22 (dusts)
- Tested according to explosion group IIB
- Time-saving installation – no need to deactivate systems / areas for welding or drilling works

EX BRS 27: Clamping range from Ø6-27 mm (3/4")
 EX BRS 90: Clamping range from Ø27 (3/4") to 89 mm (3")
 EX BRS 300: Clamping range from Ø89 (3") to 300 mm
 EX BRS 500: Clamping range from Ø300 to 500 mm
 Separate clamping body: Clamping range from Ø27 (3/4") to 500 mm

So far equipotential bonding and lightning equipotential bonding of pipes in explosion-hazardous areas have been implemented by means of welded or threaded bushing connections. Clamps may only be used if evidence of no ignition sparking in case of lightning current loading is provided. The pipe clamp of DEHN + SÖHNE is in compliance with the requirement for devoid of ignition sparks at lightning current loading. The clamp has been tested according to EN 50164-1 title English: Lightning Protection Components (LPC) – Part 1: Requirements for connection components in a potentially explosive atmosphere (clamps and connectors), and provided proof of no occurrence of ignition sparks at a lightning current loading of up to 50 kA (10/350 µs). This novel, patented pipe clamp for hazardous areas not only ensures safe electrical contact by means of two contact clips, but also adequate mechanical fixing by an electrically insulated clamping body.



Installed at a StSt pipe.



Pipe clamp for electrical contacting of pipes in explosion-hazardous areas for implementing of lightning equipotential bonding according to IEC/EN 62305-3

The Ex pipe clamp provides the following connection possibilities:

- Round conductors made of Cu, St/tZn, Al, StSt with Ø8/10 mm or flexible / stranded copper conductors, cross section 16-35 mm², with E-Cu crimping cable lug (DIN 46235)
- Flat copper conductors, min. 20 x 2.5 mm, with bore Ø10.5 mm

Environmental requirements related to the corrosion resistance of the materials used for the Ex pipe clamps Ex BRS ... (e.g. Cu/galSn, brass/galSn, StSt, polyamide) have to be taken into account.



DEHN + SÖHNE

DECLARATION OF MANUFACTURER

Product: Pipe clamp for explosive zones

Product description: Part No. 540 821
 Part No. 540 801
 Part No. 540 803
 Part No. 540 805
 Part No. 540 810

Manufacturer: DEHN + SÖHNE GmbH + Co.KG.
 Hans-Dehn-Str. 1
 92318 Neumarkt i.d.OPf., Germany

Application:

The pipe clamp for explosive zones is used for connecting pipes of different materials and diameters to the lightning equipotential bonding structure in explosive atmospheres.

Lightning currents are discharged without formation of sparks as specified in the technical data sheet.

We herewith confirm that the pipe clamp for explosive zones is suitable for the use in explosive zones 1 and 2 (gas, vapour, mist) and explosive zones 21 and 22 (combustible dust) in connection with the installation instructions, Publication No. 1599, "Pipe Clamp for explosive zones" and is tested according to explosion group IIB.

Pipe clamps for explosive zones have no own potential source of ignition (mechanical device) and are thus not subject to the European directive 94/9/EG.

Therefore certification according to the European directive 94/9/EG is **not legally admissible** and **not necessary** with respect to explosion protection.

Neumarkt i.d.OPf., 12 Okt. 2009

Ralph Brocke

Dr.-Ing. Ralph Brocke
 Director R&D

Claduram - Fotodrucke - Fremdpublizierungshinweise - Handzettel - und die Ausführung klein und groß engl. doc
 Page 11

Type EX BRS 27

Clamping range of Ø6-27 mm (3/4")



Type	EX BRS 27
Part No.	540 821
Lightning impulse current (10/350 µs) Cu Ø6-12 mm (I _{imp})	10 kA
Lightning impulse current (10/350 µs) Cu Ø12-27 mm (3/4") (I _{imp})	20 kA
Lightning impulse current (10/350 µs) Cu Ø27 mm (3/4") (I _{imp})	25 kA
Lightning impulse current (10/350 µs) St/tZn Ø17-27 mm (3/4") (I _{imp})	25 kA
Lightning impulse current (10/350 µs) StSt Ø6-12 mm (I _{imp})	10 kA
Lightning impulse current (10/350 µs) StSt Ø12-27 mm (3/4") (I _{imp})	12 kA
Lightning impulse current (10/350 µs) StSt Ø27 mm (3/4") (I _{imp})	25 kA
Connection	M8
Clamping range pipe Ø	6-27 mm (3/4")
Material of clamping body	polyamide
Material of grip head / tensioning strap	StSt
Material of contact piece	brass/gal Sn
Standard	based on EN 62561-1

Type EX BRS 90 / 300 / 500

Type EX BRS 90 Part No. 540 801 clamping range Ø27 (3/4") to 89 mm (3").

Type EX BRS 300 Part No. 540 803 clamping range Ø89 (3") to 300 mm.

Type EX BRS 500 Part No. 540 805 clamping range Ø300 to 500 mm.



Type	EX BRS 90	EX BRS 300	EX BRS 500
Part No.	540 801	540 803	540 805
Lightning impulse current (10/350 µs) Cu (I _{imp})	50 kA	50 kA	—
Lightning impulse current (10/350 µs) St/tZn (I _{imp})	50 kA	50 kA	—
Lightning impulse current (10/350 µs) St/bare (I _{imp})	—	—	50 kA
Lightning impulse current (10/350 µs) StSt (I _{imp})	25 kA	50 kA	50 kA
Connection	M10	M10	M10
Clamping range pipe Ø	27-89 mm (3/4"-3")	89 (3")-300 mm	300-500 mm
Material of clamping body	polyamide	polyamide	polyamide
Material of grip head / tensioning strap	StSt	StSt	StSt
Material of contact piece	Cu/gal Sn	Cu/gal Sn	Cu/gal Sn
Standard	EN 62561-1	EN 62561-1	EN 62561-1

Separate clamping body

For use with endless tensioning strap (Part No. 540 901), clamping ranges Ø27 (3/4") to 500 mm.



Type	SCK EX BRS ASSM10 V2A
Part No.	540 810
Lightning impulse current (10/350 µs) Cu (I _{imp})	50 kA
Lightning impulse current (10/350 µs) St/tZn (I _{imp})	50 kA
Lightning impulse current (10/350 µs) StSt (I _{imp})	25 kA
Connection	M10
Clamping range pipe Ø	27 (3/4")-500 mm
Material of clamping body	polyamide
Material of grip head / tensioning strap	StSt
Material of contact piece	Cu/gal Sn
Standard	EN 62561-1

Accessories for Pipe Clamps for Hazardous Areas Zone 1/21, 2/22

Tensioning Strap



Type	SPB 25X0.3 L100M V2A
Part No.	540 901
Material	StSt
Strap dimension (w x d)	25 x 0.3 mm
Length	100 m

Voltage Limiting Devices

- Electrical isolation of insulated track sections and earthed parts of installations
- Safe equipotential bonding in case of a short-circuit or earth fault at the overhead contact line due to high-current-resistant welding of the electrodes
- Discharge of lightning surges without short-circuit formation due to lightning-resistant SDS ... voltage limiting device
- Short-circuit withstand capability up to 25 kA_{rms} / 100 ms; 36 kA_{rms} / 75 ms



EN 50122-1 describes the use of voltage limiting devices for d.c. and a.c. traction systems for so-called „open traction system earthing“ of conductive components of the overhead contact line and pantograph zone. Voltage limiting devices (SDS ...) are used to prevent the occurrence of hazardous surges between the insulated tracks or track sections of electric railways and earthed parts of the installation.

Their function is to permanently connect parts of the installation in the overhead contact line and pantograph zone to the return circuit as soon as the threshold voltage is exceeded.

In case of atmospheric overvoltages, the lightning-resistant SDS ... voltage limiting device is capable of returning to its initial state after discharging the impulse current. Only if the specified lightning current load is exceeded, a permanent short-circuit is initiated by high-current-resistant welding of the electrodes and the fuse link has to be replaced.

The SDS voltage limiting device consists of a spark gap unit and the respective connecting kit and can be directly connected to the rail or overhead contact line tower.

The spark gap unit of type SDS 1 (Part No. 923 110) developed by DEHN + SÖHNE has also been approved by the German Federal Railway Authority (EBA).

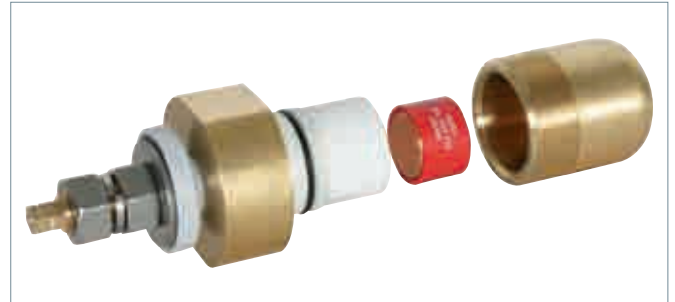

SDS 1Voltage limiting device for a power-frequency sparkover voltage ≤ 940 V.

Type SDS ...	1
Part No.	923 110
Power frequency sparkover voltage (U_{av})	≤ 940 V
d.c. sparkover voltage (U_{ag})	600 V +/- 20 %
Impulse sparkover voltage	≤ 1400 V (1kV/ μ s)
Self-extinguishing capability	300 A / 65 V
Lightning current discharge capacity (10/350 μ s) 0.1x / 0.5x / 1x	5 kA
Lightning current withstand capability (10/350 μ s)	25 kA
Safe short-circuit due to welding of the electrodes in case of alternating currents	≥ 2.5 kA / 1000 V / 30 ms, ≥ 1.5 kA / 1000 V / 100 ms
Safe short-circuit due to welding of the electrodes in case of direct currents	≥ 750 A / 250 ms
Short-circuit withstand capability	25 kA _{rms} / 100 ms; 36 kA _{rms} / 75 ms
Long-term current	1 kA _{rms} for $t \leq 120$ s
Leakage current (I_{lc})	< 1 μ A for 100 V d.c.
Operating temperature range (T_U)	-40 °C ... +80 °C
To be mounted with	mast adapter MA SDS M12 or SIEMENS No. 8WL6503-xx
Approvals	EBA
DB drawing No.	4 Ebs 15.13.20 Sheet 2

SDS 2

Voltage limiting device for a d.c. sparkover voltage of 350 V.



Type SDS ...	2
Part No.	923 117
d.c. sparkover voltage (U_{ag})	350 V +/- 20 %
Impulse sparkover voltage	≤ 900 V (1 kV/ μ s)
Lightning current discharge capacity (10/350 μ s) 0.1x / 0.5x / 1x	2 kA
Lightning current withstand capability (10/350 μ s)	25 kA
Safe short-circuit due to welding of the electrodes in case of direct currents	≥ 600 A / 250 ms
Short-circuit withstand capability	25 kA _{rms} / 100 ms; 36 kA _{rms} / 75 ms
Long-term current	1 kA _{rms} for $t \leq 120$ s
Leakage current (I_{lc})	< 1 μ A for 100 V d.c.
Operating temperature range (T_U)	-40 °C ... +80 °C
To be mounted with	mast adapter MA SDS M12 or SIEMENS No. 8WL6503-xx

SDS 3

Voltage limiting device for a d.c. sparkover voltage of 550 V.



Type SDS ...	3
Part No.	923 116
d.c. sparkover voltage (U_{ag})	550 V
Impulse sparkover voltage	≤ 1000 V (1 kV/ μ s)
Lightning current discharge capacity (10/350 μ s) 0.1x / 0.5x / 1x	2.5 kA
Lightning current withstand capability (10/350 μ s)	25 kA
Short-circuit withstand capability	25 kA _{rms} / 100 ms
Operating temperature range (T_U)	-40 °C ... +80 °C
To be mounted with	mast adapter MA SDS M12 or SIEMENS Nr. 8WL6503-xx

Voltage Limiters

SDS 4

Voltage limiting device for a d.c. sparkover voltage of 230 V.

Type SDS ...	4
Part No.	923 118
d.c. sparkover voltage (U_{ag})	230 V +/- 20%
Impulse sparkover voltage	≤ 650 V (1 kV/μs)
Lightning current discharge capacity (10/350 μs) 0.1x / 0.5x / 1x	2.5 kA
Lightning current withstand capability (10/350 μs)	25 kA
Impulse current discharge capacity (8/20 μs) 0.1x / 0.5x / 1x	20 kA
Safe short-circuit due to welding of the electrodes in case of direct currents	≥ 600 A / 250 ms
Short-circuit withstand capability	25 kA _{rms} / 100 ms; 36 kA _{rms} / 75 ms
Long-term current	1 kA _{rms} for t ≤ 120 s
Leakage current (I_{lc})	< 1 μA for 100 V d.c.
Operating temperature range (T_u)	-40 °C ... +80 °C
To be mounted with	mast adapter MA SDS M12 or SIEMENS No. 8WL6503-xx



SDS 5

Voltage limiting device for a d.c. sparkover voltage of 120 V.

Type SDS ...	5
Part No.	923 119
d.c. sparkover voltage (U_{ag})	120 V +/- 20 %
Impulse sparkover voltage	≤ 600 V (1 kV/μs)
Lightning current discharge capacity (10/350 μs) 0.1x / 0.5x / 1x	2 kA
Lightning current withstand capability (10/350 μs)	25 kA
Impulse current discharge capacity (8/20 μs) 0.1x / 0.5x / 1x	20 kA
Safe short-circuit due to welding of the electrodes in case of direct currents	≥ 600 A / 250 ms
Short-circuit withstand capability	25 kA _{rms} / 100 ms; 36 kA _{rms} / 75 ms
Long-term current	1 kA _{rms} for t ≤ 120 s
Leakage current (I_{lc})	< 1 μA for 100 V d.c.
Operating temperature range (T_u)	-40 °C ... +80 °C
To be mounted with	mast adapter MA SDS M12 or SIEMENS No. 8WL6503-xx



Accessories for Voltage Limiting Devices

Mast Adapter for SDS Voltage Limiting Devices

For installation on the mast profile of overhead contact line masts with Ø8-12 mm.

Type	MA SDS M12
Part No.	723 199
Lightning current carrying capability (10/350 μs)	25 kA
Short-circuit withstand capability	21 kA _{rms} / 30 ms
Long-term current	1 kA _{rms} at t ≤ 120 s
Leakage current (I_{lc})	< 1 μA at 100 V d.c.
Dimensions of the threaded pin	M12
Material	Brass
Degree of protection of the inner enclosure	IP 67



DEHN protects.®



Equipotential Busbars

Equipotential Busbars K12 with Snap-on Terminals

For protective and functional equipotential bonding according to IEC 60364-4-41/60364-5-54 and lightning equipotential bonding according to IEC 62305-3.

Standard type

Terminals for: 10 conductors 2.5-95 mm² (solid/stranded) or Rd Ø10 mm
1 conductor Fl up to 30 x 4 mm

Part No.	563 200
Contact bar	Cu/gal Sn
Cross-section	30 mm ²
Standard	EN 62561-1



UV stabilised type

Terminals for: 10 conductors 2.5-95 mm² (solid/stranded) or Rd Ø10 mm
1 conductor Fl up to 30 x 4 mm

Part No.	563 201
Contact bar	Cu/gal Sn
Cross-section	30 mm ²
Standard	EN 62561-1



Equipotential Busbar MS

For equipotential bonding.

Terminals for: 7 conductors Rd 2.5-25 mm² (solid/stranded)
1 conductor Rd Ø7-10 mm
1 conductor Fl up to 30 x 3.5 mm or Rd Ø8-10 mm

Part No.	563 050
Contact bar	Brass
Cross-section	35 mm ²



Equipotential Busbar with Terminal Block System Mini

For protective and functional equipotential bonding according to IEC 60364-4-41 / 60364-5-54 in small systems. Without cover.

Terminals for: 6 conductors 2.5-25 mm² (solid/stranded)

Part No.	563 105
Clamping bar	Brass/gal Sn
Cross-section	100 mm ²
Standard	EN 50164-1



Equipotential Busbars R15 with Terminal Block System / Kit

For protective and functional equipotential bonding according to IEC 60364-4-41 / 60364-5-54 and lightning equipotential bonding according to IEC 62305-3.

Type A

Terminals for: 7 conductors 2.5-25 mm² (solid/stranded)
2 conductors 16-95 mm² (solid/stranded) or Rd Ø8-10 mm
1 conductor Fl up to 30 x 4 mm



Part No.	563 010
Clamping bar	Brass/gal Sn
Cross-section	100 mm ²
Standard	EN 62561-1

Type B

Terminals for: 5 conductors 2.5-25 mm² (solid/stranded)
3 conductors 16-95 mm² (solid/stranded) or Rd Ø8-10 mm
1 conductor Fl up to 30 x 4 mm



Part No.	563 020
Clamping bar	Brass/gal Sn
Cross-section	100 mm ²
Standard	EN 62561-1

Type C

Terminals for: 13 conductors 2.5-25 mm² (solid/stranded)
1 conductor 16-95 mm² (solid/stranded) or Rd Ø8-10 mm



Part No.	563 030
Clamping bar	Brass/gal Sn
Cross-section	100 mm ²
Standard	EN 62561-1

Type D

Terminals for: 7 conductors 2,5-25 mm² (solid/stranded)
2 conductors 16-95 mm² (solid/stranded) or Rd Ø8-10 mm
1 conductor Fl up to 40 x 5 mm



Part No.	563 040
Clamping bar	Brass/gal Sn
Cross-section	100 mm ²
Standard	EN 62561-1

Terminal Block

Terminals for: 1 conductor 2.5-25 mm² (solid/stranded)

Part No.	563 011
Material	St/gal Zn
Modules	1



Terminal Block

Terminals for: 1 conductor 16-95 mm² (solid/stranded) oder Rd Ø8-10 mm

Part No.	563 013
Material	St/gal Zn
Modules	2



Terminal Block

Terminals for: 1 conductor Fl up to 30 x 4 mm

Part No.	563 012
Material	St/gal Zn
Modules	4



Terminal Block

Terminals for: 1 conductor Fl up to 40 x 5 mm

Part No.	563 019
Material	St/gal Zn
Modules	5



Clamping bar

Part No.	563 016	563 017	563 018
Material	Brass/gal Sn	Brass/gal Sn	Brass/gal Sn
Length	198 mm	398 mm	798 mm
Modules	15	30	60



Bar Frame

Part No.	563 014
Material	Plastic
Fixing bores	[2x] 6 x 12 mm
Modules	2



Cover

Snap-on / labelable cover.

Part No.	563 015
Material	Plastic
Modules	15



Equipotential Busbars Industry Design

For protective and functional equipotential bonding according to IEC 60364-4-41 / 60364-5-54 and lightning equipotential bonding according to IEC 62305-3, also for use in hazardous areas (screws are secured against self-loosening).

6 terminals

With insulators.



Part No.	472 207	472 209
Material	Cu	StSt
Dimension (l x w x d)	295 x 40 x 5 mm	295 x 40 x 6 mm
Cross-section	200 mm ²	240 mm ²
Standard	EN 62561-1	EN 62561-1

8 terminals

With insulators.



Part No.	472 227	472 229
Material	Cu	StSt
Dimension (l x w x d)	365 x 40 x 5 mm	365 x 40 x 6 mm
Cross-section	200 mm ²	240 mm ²
Standard	EN 62561-1	EN 62561-1

10 terminals

With insulators.



Part No.	472 217	472 219
Material	Cu	StSt
Dimension (l x w x d)	435 x 40 x 5 mm	435 x 40 x 6 mm
Cross-section	200 mm ²	240 mm ²
Standard	EN 62561-1	EN 62561-1

12 terminals

With insulators.



Part No.	472 237	472 239
Material	Cu	StSt
Dimension (l x w x d)	505 x 40 x 5 mm	505 x 40 x 6 mm
Cross-section	200 mm ²	240 mm ²
Standard	EN 62561-1	EN 62561-1

Accessories for Equipotential Busbars

Covers for EBB Industry Design

With insulators.



Part No.	472 279	472 269	472 289	472 299
Type of EBB	6 terminals	8 terminals	10 terminals	12 terminals
Dimension (l x w x d)	301 x 60 x 0.8 mm	371 x 60 x 0.8 mm	441 x 60 x 0.8 mm	551 x 60 x 0.8 mm
Material	StSt	StSt	StSt	StSt

Insulator for EBB Industry Design



Part No.	472 210
Material	UP (thermoset)
Connection thread	M10 (length 12 mm)
Dimension (d x h)	32 x 40 mm

Fixing Kit for EBB Industry Design



Part No.	472 201	472 202
Material of screw	St/tZn	StSt
Screw	45 mm $\frac{1}{4}$ M10 x 20 mm	45 mm $\frac{1}{4}$ M10 x 20 mm
Plastic dowel	Ø12 x 60 mm	Ø12 x 60 mm

Note: You will find our complete earthing / equipotential bonding and lightning protection portfolio in our Lightning Protection Main Catalogue.

Earthing Busbars, single-row

For screwing on steel constructions, borehole spacing of 35 mm.

1x 4 terminals

Part No.	472 309
Material	StSt
Cross-section	105 mm ²
Borehole	11 x 11 mm



1x 6 terminals

Part No.	472 319
Material	StSt
Cross-section	105 mm ²
Borehole	11 x 11 mm



1x 8 terminals

Part No.	472 329
Material	StSt
Cross-section	105 mm ²
Borehole	11 x 11 mm



1x 10 terminals

Part No.	472 339
Material	StSt
Cross-section	105 mm ²
Borehole	11 x 11 mm



1x 12 terminals

Part No.	472 349
Material	StSt
Cross-section	105 mm ²
Borehole	11 x 11 mm



Earthing Busbars, two-row

For screwing to steel constructions, borehole spacing of 50 mm.

2x 2 terminals

Part No.	472 023	472 109
Material	St/tZn	StSt
Cross-section	240 mm ²	300 mm ²
Borehole Ø	11 mm	11 mm



2x 3 terminals

Part No.	472 022	472 119
Material	St/tZn	StSt
Cross-section	240 mm ²	300 mm ²
Borehole Ø	11 mm	11 mm



2x 4 terminals

Part No.	472 024	472 129
Material	St/tZn	StSt
Cross-section	240 mm ²	300 mm ²
Borehole Ø	11 mm	11 mm



2x 6 terminals

Part No.	472 021	472 139
Material	St/tZn	StSt
Cross-section	240 mm ²	300 mm ²
Borehole Ø	11 mm	11 mm



Note: You will find our complete earthing / equipotential bonding and lightning protection portfolio in our Lightning Protection Main Catalogue.

Connecting Clamps

Connecting Clamps for Reinforcements

To connect the reinforcing steel mesh or reinforcement to round and flat conductors. Arrangement: (II) = parallel (+) = cross

For T, cross and parallel connections

Part No.	308 025
Material	St/tZn
Clamping range Rd / Rd	(+) 6-10 / 6-10 mm
Clamping range Rd / Fl	(+) 6-10 / 30 mm
Clamping range Fl / Fl	(II) 30 / 30 mm

For T, cross and parallel connections

Part No.	308 026
Material	St/tZn
Clamping range Rd / Rd	(+) 6-10 / 30 mm
Clamping range Fl / Fl	(+ / II) 30 / 30 mm

For T and cross connections

Part No.	308 030
Material	St/bare
Clamping range Rd / Fl	(+) 6-22 / 40 mm

For T, cross and parallel connections with clamping frame

For flexible connection of round conductors or for fixed earthing terminals and concurrent fixing in the formwork.



Part No.	308 035
Material	St/bare
Clamping range Rd / Rd	(+ / II) 6-22 / 6-10 mm
Clamping range Rd / Fl	(+) 6-22 / 40 mm

Pressure U-clamp

For T, cross and parallel connections.



Part No.	308 031
Material	St/bare
Clamping range Rd / Rd	(+ / II) 6-20 / 6-10 mm
Clamping range Rd / Fl	(+ / II) 6-20 / 30 x 3-4 mm
Clamping range Fl / Fl	(+ / II) 30 x 3-4 / 30 x 3-4 mm

Pressure U-clamp MAXI

For T, cross and parallel connections.



Part No.	308 036
Material	St/bare
Clamping range Rd / Rd	(+ / II) 20-32 / 6-10 mm
Clamping range Rd / Fl	(+ / II) 20-32 / 40 x 4-5 mm

U-bolt Clamp for Large Diameters

Part No.	308 045
Material	St/bare
Clamping range Rd / Rd	(II) 16-48 / 6-10 mm
Clamping range Rd / Fl	(II) 16-48 / 30-40 mm

U-bolt Clamp for Large Diameters, with two additional clamping frames

For cross connection of round conductors (6-10 mm) or for fixing and concurrent connection of fixed earthing terminals.



Part No.	308 046
Material	St/bare
Clamping range Rd / Rd	(+ / II) 16-48 / 6-10 mm
Clamping range Rd / Fl	(II) 16-48 / 30-40 mm

MAXI MV Clamps

For T, cross and parallel connections.



Part No.	308 041	308 040
Material	St/tZn	St/bare
Clamping range Rd / Rd	(+ / II) 8-16 / 15-25 mm	(+ / II) 8-16 / 15-25 mm

Note: You will find our complete earthing / equipotential bonding and lightning protection portfolio in our Lightning Protection Main Catalogue.

Components for Foundation Earth Electrodes

Connecting Clamps for Foundation Earth Electrodes

Clamps to connect round and flat conductors in the concrete foundation.
For T, cross and parallel connections, threading of conductors is not necessary.

Part No.	308 120	308 129
Material	St/tZn	StSt
Clamping range Rd / Fl	(+) 10 / 30 mm	(+) 10 / 30 mm
Clamping range Fl / Fl	(+ / II) 30 / 30 mm	(+ / II) 30 / 30 mm



Spacers angled and reinforced / straight

For installing earth conductors in the foundation slab. With safety lug to prevent loosening of the conductor.

Part No.	290 001	290 002
Type	angled and reinforced	straight
Material	St/tZn	St/tZn
Support Fl	40 mm	40 mm
Support Rd	8-10 mm	8-10 mm
Length	300 mm	280 mm



Expansion Strap for Foundation Earth Electrodes

For leading the foundation earth electrode through the expansion joints in case of large foundations (several sections), so that it is not necessary to lead the earth electrode out of the base plate.

Part No.	308 150
Material of strap	StSt
Dimension of strap (l x w x d)	approx. 700 x 30 x (4 x 1) mm
Material of block	polystyrene



Components for Ring Equipotential Bonding

Flat Strip / Round Conductor Holder with Thrust Piece

For wall mounting. Thrust piece with screw M8 for the installation of flat strip up to 11 mm and round conductor 6-10 mm.

Wall distance 11 mm

Part No.	277 230	277 237	277 239
Material of conductor holder	St/tZn	Cu	StSt
Fixing	Ø13 and 7 x 20 mm	Ø13 and 7 x 20 mm	Ø13 and 7 x 20 mm
Material of screw	StSt	StSt	StSt



Wall distance 15 mm

Part No.	277 240
Material of conductor holder	St/tZn
Fixing	7 x 15 mm
Material of screw	StSt



Connection Clamp

For universal connection to the ring equipotential bonding of St/tZn, copper or stainless steel (StSt).

Part No.	563 169
Conductor holder support Rd / Fl	Ø8-10 / 30 x 3 up to 11 mm
Material	StSt
Terminal cross sect	2.5-95 mm ²



Clamping Piece

Clamping piece for connection of flat material to construction elements or e.g. for connection clamps for steel girders (no bore in the flat strip).

Part No.	380 129
Clamping range Fl	up to 30 x 4 mm
Material	StSt
Fixing	square hole 11 x 11 mm



Note: You will find our complete earthing / equipotential bonding and lightning protection portfolio in our Lightning Protection Main Catalogue.



BLITZDUCTOR
BXT ML2 BE
S 24

No. 920 224
protected lines 1/2
 U_c 33 V
 I_{imp} 2,5/9 kA (10/350)
 U_N 24 V
 I_L 0,75 A/45 °C
DEKRA 11ATEX0089 X
IECEx DEK 11.0032X
Ex nA IIC T4 Gc
TYPE 1 P1

DEHNguard
DG MOD CI
275

DEHNguard
DG MOD CI
275

DEHN protects.®



Product documentation / construction and CAD drawings

Planning, design and implementation drawings of lightning and surge protection systems require a detailed product documentation. Computer Aided Engineering (CAE) is based on construction and CAD drawings.

DEHN provides you with the following documents and drawings for collective download:

- Installation instructions / instructions for use
- Test reports
- Certificates
- Data sheets
- Specifications
- CAD drawings (file formats: .stp, .igs, .jt, .dwg, .dxf)

Supported product ranges:

- **Surge Protection Red/Line®** and **Yellow/Line** (complete)
- **Lightning Protection/Earthing** (partly; other in preparation)
- **Safety Equipment** (partly; other in preparation)

Proceed as follows:

1. Registration under <https://www.dehn-international.com/user/register> or
2. Login under <https://www.dehn-international.com/user>
3. Selected products into the shopping cart
4. Collective download of all components in the shopping cart

Collective download of certificates and test reports

Collective download of certificates and test reports from the notepad of our website is immediately possible. Procedure is the same as with the collective downloads of data sheets etc.

Please note:

A certificate and/or test report is not available for all products.

More information under

www.dehn-international.com/en/lightning-protection

Data sheets, test reports, 3D data and more also on the internet:

<http://de.hn/enpd>

DEHNacademy – E-Learning



Easy-to-understand lightning and surge protection

What is the difference between a direct and an indirect lightning strike and how do they affect buildings? What are the causes for surges and how do they threaten electronic systems? What has to be observed when installing surge protective devices and how can installation errors be avoided? Are there special requirements for IT systems?

You will find the answers here. Become an expert "step-by-step" at your own pace. Start your learning program now. Directly on your computer – no download or installation required.

Brochures generally

- DS103E DEHN protects Wind Turbines
 DS104E DEHN protects Cell Sites
 DS109E DEHN protects Photovoltaic Systems
 DS113E DEHN tests and analyses – DEHN Test Centre
 DS144E DEHN protects Biogas Plants
 DS158E DEHNconcept – Planning of lightning protection systems
 DS180D/E DEHN protects Railway Systems
 DS197E DEHN protects Safety Systems
 DS214E DEHN protects Gas Industry Plants
 DS240E Operation and maintenance of PV power plants
 DS243E DEHN protects Smart Power Grids
 DS249E DEHN protects Pipelines
 DS275D/E DEHNdetect – Lightning current measuring system for detecting lightning events
 DS509E DEHN protects.
 DS614E DEHN stops Surges
 DS661E When Lightning Strikes – What to do during a Thunderstorm
 DS702E Lightning Protection Guide
 DS709E Planning of Lightning Protection Systems – DEHNsupport Toolbox

Brochures for Power Supply Systems

- DS125E DEHNmid and DEHNtrack protect Medium Voltage Systems
 DS187E DEHNsecure protects Direct Current Applications
 DS193E DEHNshield: Application-optimised Combined Arrester
 DS196E More Space in the Switchgear Cabinet – Arresters with integrated Backup Fuse
 DS199E DEHNshield: Universal solution for electromobility (pdf only)
 DS200D/E DEHNguard PCB ... (FM) (pdf only)
 DS218D/E DEHNcombo YPV SCI (pdf only)
 DS224D/E DEHNcube YPV SCI (pdf only)
 DS227D/E DEHNguard SE H LI (pdf only)
 DS228D/E DEHNcord (pdf only)
 DS237D/E DEHNguard SE DC (pdf only)
 DS247D/E DEHNbloc Maxi CI (pdf only)
 DS250E Selection Matrix – Lightning current and surge arresters (pdf only)
 DS253E Surge protection concept for LED street lights (pdf only)
 DS268D/E DEHNguard SE H 1000 VA – Type 2 arrester for voltages up to 1000 V (pdf only)
 DS276D/E DEHNcord R 3P – Type 2 arrester for electric shadings
 DS277D/E DEHNguard M YPV ... FM – Universal type 2 arrester with high protective effect (pdf only)
 DS281D/E DEHNshield Basic FM (pdf only)
 DS293D/E Smart Decoupling Device VCSD (pdf only)
 DS297E ACI Technology – Device safety redefined (pdf only)

Brochures for Information Technology Systems

- DS137D/E DEHNgate: Coaxial Arresters
 DS143E BLITZDUCTOR XT: Modular Lightning Current and Surge Arrester
 DS145E DEHNrapid LSA: Modular Lightning and Surge Protection
 DS150E Yellow/Line Selection Guide
 DS164E BLITZDUCTOR XTU (pdf only)
 DS188E DEHNpatch / UGKF / DEHNgate (pdf only)
 DS204D/E DEHNconnect SD2 (pdf only)
 DS235D/E DEHNbox TC 180 (pdf only)
 DS248D/E DEHNvario: Compact DIN rail mounted SPD (pdf only)
 DS260D/E DEHNvario: Surge arrester for analogue camera systems (pdf only)
 DS283D/E DEHNrecord Alert – Efficient servicing thanks to status reports of the SPDs (pdf only)

DEHN CD/DVD

- DS702 Lightning Protection Guide on CD
 DS708 Animations on DVD
 Surge Protection – Power Supply Systems
 - DEHNguard SE DC
 - DEHNguard SE H LI
 - DEHNcube protects Photovoltaic Systems
 - DEHN protects Photovoltaic Systems
 Surge Protection – Information Technology Systems
 - DEHN protects Cell Sites
 - Protection of Ex (i) circuits
 - Maintenance strategy with BLITZDUCTOR XT
 - DEHNvario: Lightning and Surge Protection for electroacoustic Systems
 Surge Protection – Lightning Equipotential Bonding
 - Pipelines exposed to lightning strikes and overvoltage
 DEHN Screensaver

Special Prints

- SD85E Testing of portable earthing and short-circuiting devices (pdf only)
 SD86E Surge protection concept for LED street lights (pdf only)

Contact

Information such as printed publications can be ordered from our
Customer Service Center: Phone: +49 9181 906 1547
 Fax: +49 9181 906 1444
 sales@dehn.de

DIN VDE standards, VDE-Verlag, Berlin**DIN VDE 0100-100:2009-06**

Low-voltage electrical installations Part 1:
Fundamental principles, assessment of general characteristics, definitions
(IEC 60364-1:2005, modified);
German implementation HD 60364-1:2008

DIN VDE 0100-410:2007-06

Low-voltage electrical installations – Part 4-41:
Protection for safety – Protection against electric shock
(IEC 60364-4-41:2005, modified);
German implementation HD 60364-4-41:2007

DIN VDE 0100-443:2016-10

Low-voltage electrical installations – Part 4-44:
Protection for safety – Protection against voltage disturbances and elec-
tromagnetic disturbances – Clause 443: Protection against overvoltages
of atmospheric origin or due to switching
(IEC 60364-4-44:2007 + A1:2015, modified);
German implementation HD 60364-4-443:2016

DIN VDE 0100-534:2016-10

Low-voltage electrical installations – Part 5-53:
Selection and erection of electrical equipment – Isolation, switching and
control – Clause 534: Devices for protection against overvoltages;
[IEC 60364-5-53:2001/A2:2015 (Clause 534), modified];
German implementation HD 60364-5-534:2016

DIN VDE 0100-540:2012-06

Low-voltage electrical installations – Part 5-54:
Selection and erection of electrical equipment – Earthing arrangements,
protective conductors and protective bonding conductors (IEC 60364-5-
54:2011);
German implementation HD 60364-5-54:2011

DIN VDE 0100-717:2010-10

Low-voltage electrical installations – Part 7-717:
Requirements for special installations or locations – Mobile or transport-
able units (IEC 60364-7-717:2009, modified);
German implementation HD 60364-7-717:2010

DIN VDE 0141:2000-01

Earthing system for special power installations with nominal voltages
above 1 kV

DIN VDE 0618-1:1989-08

Equipment for equipotential bonding; equipotential bonding bush for
main equipotential bonding

DIN V VDE V 0800-2:2011-06

Information technology; Equipotential bonding and earthing (additional
specifications)

DIN EN 41003

DIN VDE 0804-100:2009-04
Particular safety requirements for equipment to be connected to telecom-
munication networks;
German version EN 41003:2008

DIN EN 50178

DIN VDE 0160:1998-04
Electronic equipment for use in power installations;
German version EN 50178:1997

DIN EN 60060-1

DIN VDE 0432-1:2011-10
High voltage test techniques – Part 1:
General specifications and test requirements (IEC 60060-1:2010);
German version EN 60060-1:2010

DIN EN 60099-1

DIN VDE 0675-1:2000-08
Surge arresters – Part 1: Non-linear resistor type gapped surge arresters
for a.c. systems (IEC 60099-1:1991)
German version EN 60099-1:1994 + A1:1999

DIN EN 60664-1

DIN VDE 0110-1:2008-01
Insulation coordination for equipment within low-voltage systems –
Part 1: Principles, requirements and tests (IEC 60664-1:2007)
German version EN 60664-1:2007

DIN EN 60728-11

VDE 0855-1:2011-06
Cable networks for television signals, sound signals and interactive ser-
vices – Part 11: Safety (IEC 60728-11:2010);
German version EN 60728-11:2010

DIN EN 61643-11

VDE 0675-6-11:2013-04
Low-voltage surge protective devices – Part 11:
Surge protective devices connected to low-voltage power systems;
Requirements and tests (IEC 61643-11:2011, modified);
German version EN 61643-11:2012

DIN EN 62305-1

VDE 0185-305-1:2011-10
Protection against lightning – Part 1:
General principles (IEC 62305-1:2010, modified);
German version EN 62305-1:2011

DIN EN 62305-2

VDE 0185-305-2:2013-02
Protection against lightning – Part 2:
Risk management (IEC 62305-2:2010, modified);
German version EN 62305-2:2012

DIN EN 62305-3

VDE 0185-305-3:2011-10
Protection against lightning – Part 3:
Physical damage to structures and live hazard
(IEC 62305-3:2010, modified);
German version EN 62305-3:2011

DIN EN 62305-4

VDE 0185-305-4:2011-10
Protection against lightning – Part 4: Electrical and electronic systems
within structures (IEC 62305-4:2010, modified);
German version EN 62305-4:2011

DIN EN 62561-1

VDE 0185-561-1:2017-12
Lightning Protection System Components (LPSC) – Part 1:
Requirements for connection components (IEC 62561-1:2017, modified);
German version EN 62561-1:2017

DIN 18014:2014-03

Foundation earth electrode – Planning, execution and documentation

IEC 60664-1:2007-04

Insulation coordination for equipment within low-voltage systems; part 1: principles, requirements and tests

IEC 61643-11:2011-03

Low-voltage surge protective devices – Part 11: Surge protective devices connected to low-voltage power distribution systems – Requirements and testing methods

IEC 61643-21:2013-07

Low voltage surge protective devices – Part 21: Surge protective devices connected to telecommunications and signalling networks; Performance requirements and testing methods

IEC 62305-1:2010-12

Protection against lightning; Part 1: General principles

IEC 62305-2:2010-12

Protection against lightning; Part 2: Risk management

IEC 62305-3:2010-12

Protection against lightning – Part 3: Physical damage to structures and life hazard

IEC 62305-4:2010-12

Protection against lightning – Part 4: Electrical and electronic systems within structures

VG Normen, Beuth-Verlag GmbH

VG 95 372:2013-11

Electromagnetic Compatibility (EMC) including Electromagnetic Pulse (EMP) and Lightning Protection – Survey

VG 95 371-10:2011-09

Electromagnetic compatibility (EMC) including electromagnetic pulse (EMP) and lightning protection – Fundamentals – Part 10: Threat levels for NEMP and lightning
Supplement 1:2012-02, Supplement 2:2012-02

VG 96 907-1:2013-01

Nuclear Electromagnetic Pulse (NEMP) and lightning protection – Design guidelines and protective devices – Part 1: Fundamentals

Further standards

DVGW GW 309:2013-09

Elektrische Überbrückung bei Rohrtrennungen
[Electrical bridging of separate pipe sections]
ZfGW-Verlag GmbH, Frankfurt.

AfK-Empfehlung Nr. 5:2014-02

Kathodischer Korrosionsschutz in Verbindung mit explosionsgefährdeten Bereichen.

[AfK recommendation No. 5:2010-07, Cathodic corrosion protection in connection with potentially explosive atmospheres]
ZfGW-Verlag GmbH, Frankfurt.

KTA 2206/2009-11:

Auslegung von Kernkraftwerken gegen Blitzeinwirkung.
[Protection for nuclear power plants against lightning effects]

Books

Landers E.U., Zahlmann P.:

“EMV – Blitzschutz von elektrischen und elektronischen Systemen in baulichen Anlagen – Risiko-Management, Planen und Ausführen nach den neuen Normen der Reihe VDE 0185- 305-x (VDE 0185-305-x)”
3. vollständig überarbeitete Auflage 2013,

[EMC-based lightning protection for electrical and electronic systems in structures – Risk management, design and installation according to the new standard series IN VDE 0185-305-x (VDE 0185-305-x),
3rd completely revised edition of 2013],

VDE series volume No. 185, Berlin-Offenbach: VDE Verlag GmbH,
ISBN 978-3-8007-3399-6

DEHN + SÖHNE GmbH + Co. KG.

Lightning Protection Guide,
3rd updated edition 2015,
ISBN 978-3-9813770-1-9

Part No. / GTIN* / PG / Weight / PU / SU / Page

Part No.	GTIN*	PG	Weight	PU	SU	Page
106 310	096813	01 01 01 06	100 g	20	pc(s)	222
106 314	136304	04 02 08 50	100 g	1	pc(s)	222
106 329	107182	01 01 01 06	143 g	1	pc(s)	222
200 039	129283	01 04 01 04	40 g	10	pc(s)	205
277 230	110984	01 05 01 04	120 g	25	pc(s)	259
277 237	110991	01 05 01 04	126 g	25	pc(s)	259
277 239	111004	01 05 01 04	117 g	25	pc(s)	259
277 240	022577	01 05 01 04	167 g	25	pc(s)	259
290 001	027909	03 01 01 01	326 g	25	pc(s)	259
290 002	027893	03 01 01 01	89 g	50	pc(s)	259
308 025	035881	03 01 01 01	100 g	50	pc(s)	258
308 026	035874	03 01 01 01	107 g	25	pc(s)	258
308 030	030749	03 01 01 01	125 g	25	pc(s)	258
308 031	136571	03 01 01 01	230 g	25	pc(s)	258
308 035	123472	03 01 01 01	165 g	25	pc(s)	258
308 036	136588	03 01 01 01	266 g	25	pc(s)	258
308 040	055902	03 01 01 01	450 g	20	pc(s)	258
308 041	056411	03 01 01 01	471 g	20	pc(s)	258
308 045	124455	03 01 01 01	262 g	25	pc(s)	258
308 046	124462	03 01 01 01	288 g	25	pc(s)	258
308 120	099258	03 01 01 01	134 g	25	pc(s)	259
308 129	099265	03 01 01 01	131 g	25	pc(s)	259
308 150	106970	03 01 01 01	682 g	1	pc(s)	259
308 403	070509	04 02 10 01	26 g	10	pc(s)	227
308 404	070516	04 02 10 01	32 g	10	pc(s)	227
308 405	070523	04 02 10 01	37 g	10	pc(s)	227
308 406	070530	04 02 10 01	49 g	10	pc(s)	227
308 407	070547	04 02 10 01	60 g	10	pc(s)	227
308 408	070554	04 02 10 01	73 g	10	pc(s)	227
308 411	070578	04 02 10 01	56 g	5	pc(s)	227
308 421	070561	04 02 10 50	974 g	10	pc(s)	227
308 425	058798	04 02 10 01	19 g	10	pc(s)	227
380 129	150416	01 04 01 02	100 g	50	pc(s)	259
416 411	032545	03 07 01 01	266 g	1	pc(s)	222
472 021	027879	01 05 01 03	866 g	1	pc(s)	257
472 022	030305	01 05 01 03	588 g	1	pc(s)	257
472 023	030312	01 05 01 03	507 g	1	pc(s)	257
472 024	034495	01 05 01 03	677 g	1	pc(s)	257
472 109	074477	01 05 01 03	604 g	1	pc(s)	257
472 119	074484	01 05 01 03	740 g	1	pc(s)	257
472 129	074491	01 05 01 03	841 g	1	pc(s)	257
472 139	074507	01 05 01 03	1.1 kg	1	pc(s)	257
472 201	089631	01 06 01 01	66 g	1	pc(s)	256
472 202	147331	01 06 01 01	70 g	1	pc(s)	256
472 207	090927	01 05 01 03	964 g	1	pc(s)	256
472 209	090934	01 05 01 03	1.01 kg	1	pc(s)	256
472 210	096790	01 06 01 01	92 g	1	pc(s)	256
472 217	090941	01 05 01 03	1.35 kg	1	pc(s)	256
472 219	090958	01 05 01 03	1.41 kg	1	pc(s)	256
472 227	096424	01 05 01 03	1.14 kg	1	pc(s)	256
472 229	096431	01 05 01 03	1.18 kg	1	pc(s)	256
472 237	096448	01 05 01 03	1.53 kg	1	pc(s)	256
472 239	096455	01 05 01 03	1.59 kg	1	pc(s)	256
472 269	096462	01 05 01 03	322 g	1	pc(s)	256

Part No.	GTIN*	PG	Weight	PU	SU	Page
472 279	090972	01 05 01 03	285 g	1	pc(s)	256
472 289	090989	01 05 01 03	366 g	1	pc(s)	256
472 299	096479	01 05 01 03	403 g	1	pc(s)	256
472 309	157170	01 05 01 03	226 g	1	pc(s)	257
472 319	157187	01 05 01 03	267 g	1	pc(s)	257
472 329	157194	01 05 01 03	307 g	1	pc(s)	257
472 339	157200	01 05 01 03	348 g	1	pc(s)	257
472 349	157217	01 05 01 03	387 g	1	pc(s)	257
540 200	113039	01 05 01 02	136 g	10	pc(s)	205
540 801	115460	01 05 01 05	503 g	1	pc(s)	248
540 803	115477	01 05 01 05	566 g	1	pc(s)	248
540 805	128873	01 05 01 05	766 g	1	pc(s)	248
540 810	115484	01 05 01 05	550 g	1	pc(s)	248
540 821	123724	01 05 01 05	249 g	1	pc(s)	248
540 901	076525	01 05 01 02	6.28 kg	1	pc(s)	248
563 010	027800	01 05 01 03	469 g	1	pc(s)	254
563 011	027732	01 05 01 03	13 g	200	pc(s)	255
563 012	027749	01 05 01 03	63 g	25	pc(s)	255
563 013	027756	01 05 01 03	32 g	100	pc(s)	255
563 014	027787	01 05 01 03	11 g	50	pc(s)	255
563 015	027794	01 05 01 03	59 g	10	pc(s)	255
563 016	027763	01 05 01 03	166 g	10	pc(s)	255
563 017	027770	01 05 01 03	370 g	10	pc(s)	255
563 018	083585	01 05 01 03	672 g	10	pc(s)	253
563 019	096998	01 05 01 03	65 g	25	pc(s)	255
563 020	027817	01 05 01 03	476 g	1	pc(s)	254
563 030	027824	01 05 01 03	444 g	1	pc(s)	254
563 040	082861	01 05 01 03	460 g	1	pc(s)	254
563 050	054707	01 05 01 03	231 g	20	pc(s)	253
563 105	027831	01 05 01 03	210 g	10	pc(s)	253
563 169	104839	01 05 01 04	76 g	50	pc(s)	259
563 200	056558	01 05 01 03	410 g	1	pc(s)	253
563 201	101234	01 05 01 03	397 g	1	pc(s)	253
723 199	151703	05 03 01 01	750 g	1	pc(s)	251
900 050	107496	04 01 01 14	507 g	1	pc(s)	52
900 060	153707	04 01 01 05	374 g	1	pc(s)	33
900 061	153721	04 01 01 05	433 g	1	pc(s)	33
900 062	153745	04 01 01 05	524 g	1	pc(s)	33
900 065	153714	04 01 01 05	378 g	1	pc(s)	33
900 066	153738	04 01 01 05	437 g	1	pc(s)	33
900 067	153752	04 01 01 05	530 g	1	pc(s)	33
900 120	109377	04 01 01 13	873 g	1	pc(s)	49
900 220	106734	04 01 01 11	699 g	1	pc(s)	44
900 222	102521	04 01 01 13	331 g	1	pc(s)	49
900 230	153783	04 01 01 07	1.49 kg	1	pc(s)	35
900 255	125773	04 01 01 09	194 g	1	pc(s)	39
900 261	094352	04 01 02 16	158 g	1	pc(s)	102
900 262	072572	04 01 02 16	158 g	1	pc(s)	102
900 263	094369	04 01 02 16	194 g	1	pc(s)	102
900 264	073661	04 01 02 16	157 g	1	pc(s)	102
900 270	106703	04 01 02 16	223 g	1	pc(s)	102
900 271	106710	04 01 02 16	224 g	1	pc(s)	102
900 411	107205	04 01 01 50	54 g	1	pc(s)	125
900 417	120419	04 01 01 50	66 g	1	pc(s)	125
900 418	159884	04 01 02 50	49 g	1	pc(s)	125
900 419	156821	04 01 02 50	39 g	1	pc(s)	125
900 429	159891	04 01 02 50	59 g	1	pc(s)	125

Part No. / GTIN* / PG / Weight / PU / SU / Page

Part No.	GTIN*	PG	Weight	PU	SU	Page
928 430	261389	04 02 03 02	110 g	1	pc(s)	182
928 440	280809	04 02 03 02	135 g	1	pc(s)	182
929 010	039940	04 02 08 01	68 g	1	pc(s)	218
929 024	093355	04 02 07 04	113 g	1	pc(s)	215
929 034	072145	04 02 06 50	2.4 kg	1	pc(s)	207
929 035	072619	04 02 06 02	270 g	1	pc(s)	206
929 037	090637	04 02 06 02	270 g	1	pc(s)	206
929 039	135185	04 02 08 03	24 g	1	pc(s)	220
929 040	080294	04 02 08 01	21 g	1	pc(s)	220
929 042	091030	04 02 08 03	39 g	1	pc(s)	220
929 043	091047	04 02 08 03	90 g	1	pc(s)	220
929 044	091054	04 02 08 03	86 g	1	pc(s)	220
929 045	091061	04 02 08 03	266 g	1	pc(s)	220
929 047	091085	04 02 08 03	467 g	1	pc(s)	221
929 071	082823	04 02 06 02	240 g	1	pc(s)	207
929 072	083165	04 02 06 02	257 g	1	pc(s)	207
929 095	113398	04 02 08 50	90 g	1	pc(s)	222
929 096	107212	04 02 08 50	203 g	1	pc(s)	222
929 100	102170	04 02 06 01	244 g	1	pc(s)	204
929 121	118935	04 02 06 01	109 g	1	pc(s)	204
929 126	242258	04 02 06 01	96 g	1	pc(s)	204
929 146	157156	04 02 08 03	471 g	1	pc(s)	221
929 148	157163	04 02 08 03	448 g	1	pc(s)	221
929 199	103313	04 02 06 50	350 g	1	pc(s)	205
929 200	344082	04 02 06 50	7 g	1	pc(s)	205
929 221	342866	04 02 06 01	606 g	1	pc(s)	203
929 230	130852	04 02 06 02	89 g	1	pc(s)	207
929 234	130838	04 02 06 50	744 g	1	pc(s)	207
929 335	228672	04 02 06 50	1.38 kg	1	pc(s)	205
929 497	104143	04 02 08 50	2 g	1	pc(s)	222
929 498	104136	04 02 08 50	2 g	1	pc(s)	222
929 499	104129	04 02 08 50	2 g	1	pc(s)	222
929 921	098169	04 02 05 01	218 g	1	pc(s)	198
929 941	098152	04 02 05 01	173 g	1	pc(s)	198
929 950	137387	04 02 05 03	222 g	1	pc(s)	200
929 951	137394	04 02 05 03	222 g	1	pc(s)	200
929 960	098145	04 02 05 01	172 g	1	pc(s)	199
929 961	101784	04 02 05 02	169 g	1	pc(s)	199
929 962	101791	04 02 05 02	169 g	1	pc(s)	199
929 963	101807	04 02 05 02	172 g	1	pc(s)	199
929 964	101814	04 02 05 02	169 g	1	pc(s)	199
929 965	360778	04 02 05 01	171 g	1	pc(s)	199
929 969	127418	04 02 05 03	255 g	1	pc(s)	200
929 970	127425	04 02 05 03	248 g	1	pc(s)	200
929 971	120761	04 02 05 01	272 g	1	pc(s)	199
929 982	098695	04 02 05 50	36 g	1	pc(s)	200
929 984	098688	04 02 05 50	30 g	1	pc(s)	200
929 996	098244	04 02 05 50	13 g	1	pc(s)	200
941 110	137899	04 01 01 04	275 g	1	pc(s)	32
941 115	289208	04 01 01 04	285 g	1	pc(s)	32
941 116	373235	04 01 01 04	285 g	1	pc(s)	32
941 200	138209	04 01 01 04	250 g	1	pc(s)	31
941 205	289185	04 01 01 04	260 g	1	pc(s)	31
941 206	373839	04 01 01 04	260 g	1	pc(s)	31
941 300	133556	04 01 01 04	386 g	1	pc(s)	29
941 305	275317	04 01 01 04	361 g	1	pc(s)	29
941 306	328068	04 01 01 04	362 g	1	pc(s)	29
941 310	131798	04 01 01 04	480 g	1	pc(s)	30
941 315	275324	04 01 01 04	448 g	1	pc(s)	30

Part No.	GTIN*	PG	Weight	PU	SU	Page
941 316	328075	04 01 01 04	450 g	1	pc(s)	31
941 400	133563	04 01 01 04	525 g	1	pc(s)	29
941 405	275331	04 01 01 04	428 g	1	pc(s)	30
941 406	328082	04 01 01 04	429 g	1	pc(s)	30
950 102	105621	04 01 02 13	184 g	1	pc(s)	100
950 112	105638	04 01 02 13	196 g	1	pc(s)	100
950 530	152960	04 01 02 09	300 g	1	pc(s)	92
950 531	152953	04 01 02 09	275 g	1	pc(s)	92
950 535	154988	04 01 02 09	310 g	1	pc(s)	92
950 536	154995	04 01 02 09	285 g	1	pc(s)	92
951 001	108066	04 01 01 01	192 g	1	pc(s)	25
951 050	108073	04 01 01 01	171 g	1	pc(s)	25
951 100	108080	04 01 01 01	171 g	1	pc(s)	25
951 110	108110	04 01 01 01	659 g	1	pc(s)	24
951 115	108127	04 01 01 01	664 g	1	pc(s)	24
951 200	108097	04 01 01 01	724 g	1	pc(s)	24
951 205	108103	04 01 01 01	669 g	1	pc(s)	24
951 300	108134	04 01 01 01	970 g	1	pc(s)	23
951 305	108141	04 01 01 01	962 g	1	pc(s)	23
951 310	108172	04 01 01 01	1.27 kg	1	pc(s)	23
951 315	108189	04 01 01 01	1.28 kg	1	pc(s)	23
951 400	108158	04 01 01 01	1.35 kg	1	pc(s)	23
951 405	108165	04 01 01 01	1.36 kg	1	pc(s)	23
952 010	108356	04 01 02 01	43 g	1	pc(s)	98
952 011	109773	04 01 02 01	32 g	1	pc(s)	98
952 012	109780	04 01 02 01	35 g	1	pc(s)	98
952 013	109797	04 01 02 01	46 g	1	pc(s)	98
952 014	108363	04 01 02 01	50 g	1	pc(s)	98
952 015	109803	04 01 02 01	53 g	1	pc(s)	98
952 016	109810	04 01 02 01	64 g	1	pc(s)	98
952 017	113329	04 01 02 01	63 g	1	pc(s)	98
952 018	119482	04 01 02 01	37 g	1	pc(s)	98
952 020	127784	04 01 02 03	52 g	1	pc(s)	97
952 025	127357	04 01 02 04	34 g	1	pc(s)	98
952 027	127364	04 01 02 04	40 g	1	pc(s)	98
952 029	127371	04 01 02 04	44 g	1	pc(s)	98
952 030	108530	04 01 02 06	111 g	1	pc(s)	83
952 035	108547	04 01 02 06	114 g	1	pc(s)	83
952 041	141841	04 01 02 07	53 g	1	pc(s)	99
952 043	141834	04 01 02 07	42 g	1	pc(s)	99
952 044	141858	04 01 02 07	62 g	1	pc(s)	99
952 045	141827	04 01 02 07	33 g	1	pc(s)	99
952 048	327733	04 01 02 22	51 g	1	pc(s)	98
952 049	327740	04 01 02 22	60 g	1	pc(s)	98
952 050	108370	04 01 02 01	38 g	1	pc(s)	98
952 051	126442	04 01 02 07	49 g	1	pc(s)	99
952 053	127647	04 01 02 07	42 g	1	pc(s)	99
952 054	127975	04 01 02 07	52 g	1	pc(s)	99
952 055	136700	04 01 02 07	36 g	1	pc(s)	99
952 056	149106	04 01 02 08	71 g	1	pc(s)	99
952 060	108387	04 01 02 06	37 g	1	pc(s)	98
952 070	108493	04 01 02 02	130 g	1	pc(s)	68
952 071	109834	04 01 02 02	107 g	1	pc(s)	68
952 072	109858	04 01 02 02	109 g	1	pc(s)	68
952 073	109872	04 01 02 02	119 g	1	pc(s)	68
952 074	108516	04 01 02 02	123 g	1	pc(s)	68
952 075	109896	04 01 02 02	142 g	1	pc(s)	68
952 076	109919	04 01 02 02	136 g	1	pc(s)	68

Part No. / GTIN* / PG / Weight / PU / SU / Page

Part No.	GTIN*	PG	Weight	PU	SU	Page
952 923	322639	04 01 02 23	167 g	1	pc(s)	60
952 926	322646	04 01 02 23	72 g	1	pc(s)	97
952 927	322653	04 01 02 23	78 g	1	pc(s)	97
952 930	158559	04 01 02 14	171 g	1	pc(s)	72
952 937	158603	04 01 02 14	207 g	1	pc(s)	72
952 938	264014	04 01 02 14	207 g	1	pc(s)	72
952 940	308329	04 01 02 14	207 g	1	pc(s)	72
952 941	228177	04 01 02 12	18 g	72	pc(s)	96
952 948	323919	04 01 02 12	18 g	1	pc(s)	96
952 949	323926	04 01 02 12	18 g	1	pc(s)	96
952 951	228184	04 01 02 12	18 g	72	pc(s)	96
953 010	108295	04 01 03 01	28 g	1	pc(s)	107
953 011	109636	04 01 03 01	27 g	1	pc(s)	107
953 012	109643	04 01 03 01	27 g	1	pc(s)	107
953 013	109650	04 01 03 01	25 g	1	pc(s)	107
953 014	109667	04 01 03 01	26 g	1	pc(s)	107
953 020	117440	04 01 03 01	59 g	1	pc(s)	107
953 021	353077	04 01 03 01	49 g	1	pc(s)	107
953 200	108301	04 01 03 01	81 g	1	pc(s)	104
953 201	109674	04 01 03 01	80 g	1	pc(s)	104
953 202	109681	04 01 03 01	81 g	1	pc(s)	104
953 203	109698	04 01 03 01	79 g	1	pc(s)	104
953 204	109704	04 01 03 01	79 g	1	pc(s)	104
953 205	108318	04 01 03 01	84 g	1	pc(s)	105
953 206	109711	04 01 03 01	84 g	1	pc(s)	105
953 207	109728	04 01 03 01	85 g	1	pc(s)	105
953 208	109735	04 01 03 01	83 g	1	pc(s)	105
953 209	109742	04 01 03 01	82 g	1	pc(s)	105
953 228	158986	04 01 03 01	79 g	1	pc(s)	105
953 229	158993	04 01 03 01	83 g	1	pc(s)	105
953 400	115767	04 01 03 01	147 g	1	pc(s)	106
953 405	115774	04 01 03 01	151 g	1	pc(s)	106
953 406	353060	04 01 03 01	151 g	1	pc(s)	106
961 001	118584	04 01 01 08	173 g	1	pc(s)	37
961 002	118591	04 01 01 08	195 g	1	pc(s)	37
961 003	118607	04 01 01 08	180 g	1	pc(s)	37
961 010	118744	04 01 01 14	170 g	1	pc(s)	53
961 020	118706	04 01 01 14	139 g	1	pc(s)	53
961 022	118669	04 01 01 08	195 g	1	pc(s)	48
961 101	118676	04 01 01 14	315 g	1	pc(s)	52
961 102	118690	04 01 01 14	284 g	1	pc(s)	52
961 105	118683	04 01 01 14	320 g	1	pc(s)	52
961 110	118560	04 01 01 08	317 g	1	pc(s)	36
961 115	118577	04 01 01 08	321 g	1	pc(s)	37
961 120	118614	04 01 01 08	340 g	1	pc(s)	36
961 122	118652	04 01 01 08	358 g	1	pc(s)	48

Part No.	GTIN*	PG	Weight	PU	SU	Page
961 125	118621	04 01 01 08	343 g	1	pc(s)	37
961 130	118638	04 01 01 08	325 g	1	pc(s)	36
961 135	118645	04 01 01 08	330 g	1	pc(s)	37
961 140	116269	04 01 01 09	546 g	1	pc(s)	43
961 145	116276	04 01 01 09	520 g	1	pc(s)	43
961 146	250062	04 01 01 10	946 g	1	pc(s)	41
961 160	116290	04 01 01 14	369 g	1	pc(s)	52
961 165	116306	04 01 01 14	372 g	1	pc(s)	52
961 175	116283	04 01 01 09	507 g	1	pc(s)	43
961 176	250123	04 01 01 10	908 g	1	pc(s)	41
961 180	157323	04 01 01 14	370 g	1	pc(s)	52
961 185	157330	04 01 01 14	370 g	1	pc(s)	52
961 200	145108	04 01 01 03	432 g	1	pc(s)	27
961 205	145115	04 01 01 03	435 g	1	pc(s)	27
971 001	138605	04 01 01 12	139 g	1	pc(s)	47
971 002	133655	04 01 01 12	106 g	1	pc(s)	47
971 003	144491	04 01 01 12	109 g	1	pc(s)	47
971 010	138636	04 01 01 12	171 g	1	pc(s)	47
971 120	133631	04 01 01 12	252 g	1	pc(s)	46
971 121	138582	04 01 01 12	284 g	1	pc(s)	46
971 122	144477	04 01 01 12	258 g	1	pc(s)	46
971 125	133648	04 01 01 12	226 g	1	pc(s)	47
971 126	138599	04 01 01 12	288 g	1	pc(s)	47
971 127	144484	04 01 01 12	254 g	1	pc(s)	47
971 221	138612	04 01 01 12	608 g	1	pc(s)	47
971 226	138629	04 01 01 12	614 g	1	pc(s)	47
972 010	158672	04 01 02 15	48 g	1	pc(s)	99
972 020	158702	04 01 02 15	57 g	1	pc(s)	99
972 030	158719	04 01 02 15	71 g	1	pc(s)	99
972 040	158764	04 01 02 15	77 g	1	pc(s)	99
972 110	158504	04 01 02 15	138 g	1	pc(s)	85
972 115	158511	04 01 02 15	142 g	1	pc(s)	85
972 120	158528	04 01 02 15	148 g	1	pc(s)	85
972 125	158610	04 01 02 15	152 g	1	pc(s)	85
972 130	158627	04 01 02 15	162 g	1	pc(s)	85
972 135	158634	04 01 02 15	167 g	1	pc(s)	85
972 140	158641	04 01 02 15	168 g	1	pc(s)	85
972 145	158658	04 01 02 15	172 g	1	pc(s)	85
989 408	120396	04 02 11 01	1 kg	1	pc(s)	172
999 799	328723	04 01 02 07	509 g	1	pc(s)	89
999 906	310926	04 01 02 05	54 g	1	pc(s)	82
999 937	303195	04 01 02 05	56 g	1	pc(s)	81
999 990	153776	04 01 06 01	5 kg	1	pc(s)	244

Type	Page No.	Page	Type	Page No.	Page	Type	Page No.	Page	Type	Page No.	Page
DRL RD 60	907 444	190	EB 1 2 5	900 419	125	MB2 10 LSA	907 995	194	SAK 6.5 SN MS	919 010	228
DRL RE 12	907 421	189	EB 1 3 1.5	900 418	125	MF DR 3RU 19"	929 335	205	SAK BXT LR	920 395	173
DRL RE 180	907 425	189	EB 1 3 10	900 461	126	MS DPA	929 199	205	SDS 1	923 110	250
DRL RE 24	907 422	189	EB 1 4 1.5	900 429	125	MS EB DPA DGA	929 200	205	SDS 2	923 117	250
DRL RE 48	907 423	189	EB 1 4 13	900 462	126	MVS 1 2	900 617	123	SDS 3	923 116	250
DRL RE 5	907 420	189	EB 1 4 9	900 417	125	MVS 1 3	900 615	123	SDS 4	923 118	251
DRL RE 60	907 424	189	EB 4 F	929 095	222	MVS 1 4	900 610	123	SDS 5	923 119	251
DSA 230 LA	924 370	111	EB DG 1000 1 3	900 411	125	MVS 1 57	900 612	124	SFL PRO 6X	909 250	118
DSE M 1 220	971 120	46	EF 10 DRL	907 498	191	MVS 1 6	900 815	123	SFL PRO 6X 19"	909 251	118
DSE M 1 220 FM	971 125	47	EG NET PRO 10X 19"	929 234	207	MVS 1 7	900 848	123	SH 18X3 K	919 014	228
DSE M 1 242	971 122	46	EG NET PRO 19"	929 034	207	MVS 1 8	900 611	124	SH1 18X3 ST	919 012	228
DSE M 1 242 FM	971 127	47	EL 16 B17	929 096	222	MVS 3 6 6	900 595	124	SH2 18X3 ST	919 013	228
DSE M 1 60	971 121	46	EL2 38EA LSA	907 993	195	MVS 3 6 8	900 813	124	SKB 19 9M SW	919 030	229
DSE M 1 60 FM	971 126	47	EM 2 DRL	907 496	191	MVS 3 6 9	900 839	124	SLK 16	910 099	230
DSE M 2P 60	971 221	47	ER DPI M20	929 996	200	MVS 4 56	900 614	124	SN 18X3 CU 1000	919 016	228
DSE M 2P 60 FM	971 226	47	EX BRS 27	540 821	248	MVS 4 8 11	900 814	124	SPB 25X0.3 L100M V2A	540 901	248
DSE MOD 220	971 002	47	EX BRS 300	540 803	248	NAK SN4631	999 990	244	SPD+POP 2 255 C25	900 780	79
DSE MOD 242	971 003	47	EX BRS 500	540 805	248	NET PRO 10X TC1 RST	929 230	207	SPD+POP 2 255 C32	900 781	79
DSE MOD 60	971 001	47	EX BRS 90	540 801	248	NET PRO 4TP	929 035	206	SPD+POP 2 255 C40	900 782	79
DSE MOD PE 60	971 010	47	EXFS 100	923 100	242	NET PRO 4TP 30	929 037	206	SPD+POP 4 255 C25	900 785	79
DSH B TN 255 FM	941 206	31	EXFS 100 KU	923 101	243	NET PRO TC 2	929 071	207	SPD+POP 4 255 C32	900 786	79
DSH B TNC 255 FM	941 306	29	EXFS KU	923 019	241	NET PRO TC 2 LSA	929 072	207	SPD+POP 4 255 C40	900 787	79
DSH B TNS 255 FM	941 406	30	EXFS L100	923 060	241	NF 10	912 254	108	SPD+POP 4 255 C63	900 788	79
DSH B TT 255 FM	941 316	31	EXFS L200	923 061	241	NSM PRO TW	924 335	112	SPS PRO	912 253	109
DSH B TT 2P 255 FM	941 116	32	EXFS L300	923 062	241	P 3	910 512	126	SR DRL	907 497	191
DSH TN 255	941 200	31	FS 9E PB 6	924 017	223	PA BXT	910 508	234	ST AS SAK K	308 425	227
DSH TN 255 FM	941 205	31	GDT 230 B3	907 218	191	PLOV IGA 12 24	902 317	122	STAK 25	952 589	120
DSH TNC 255	941 300	29	GDT 230 B3 FSD	907 219	191	PM 20	910 511	127	STAK 2X16	900 589	120
DSH TNC 255 FM	941 305	29	GDT 230 G3	907 208	192	PM 20	910 511	234	STAK 3X16	900 588	120
DSH TNS 255	941 400	29	GDT 230 G3 FSD	907 217	192	POP 2 255 C25	900 760	79	STC 230	924 350	113
DSH TNS 255 FM	941 405	30	GDT DGA 230	929 498	222	POP 2 255 C32	900 761	79	TFS	923 023	240
DSH TT 255	941 310	30	GDT DGA 470	929 499	222	POP 2 255 C40	900 762	79	TL2 10DA CC	907 991	195
DSH TT 255 FM	941 315	30	GDT DGA 90	929 497	222	POP 4 255 C25	900 765	79	TL2 10DA LSA	907 996	195
DSH TT 2P 255	941 110	32	IGA 10 V2 IP54	902 315	121	POP 4 255 C32	900 766	79	TW DRC MCM EX	910 697	172
DSH TT 2P 255 FM	941 115	32	IGA 12 IP54	902 471	122	POP 4 255 C40	900 767	79	TW DRC MCM EX	910 697	232
DSI E 3	910 631	45	IGA 12 IP65	902 316	122	POP 4 255 C63	900 768	79	UGKF BNC	929 010	218
DSO 1 255	900 230	35	IGA 24 IP54	902 472	122	PSU DC24 30W	910 499	174	USB NANO 485	910 486	174
DV M TN 255	951 200	24	IGA 6 IP54	902 485	121	PSU DC24 30W	910 499	232	USB NANO 485	910 486	232
DV M TN 255 FM	951 205	24	IGA 7 IP54	902 314	121	SA KRF 10 V2A	919 031	229	V NH00 280	900 261	102
DV M TNC 255	951 300	23	ITAK EXI BXT 24	989 408	172	SA KRF 15 V2A	919 032	229	V NH00 280 FM	900 263	102
DV M TNC 255 FM	951 305	23	KB 10 DCO RK	919 880	180	SA KRF 22 V2A	919 033	229	V NH1 280	900 270	102
DV M TNS 255	951 400	23	KFSU	923 021	240	SA KRF 29 V2A	919 034	229	VA NH00 280	900 262	102
DV M TNS 255 FM	951 405	23	KV M20 MS 10.5	929 984	200	SA KRF 37 V2A	919 035	229	VA NH00 280 FM	900 264	102
DV M TT 255	951 310	23	KV S M20 MS 9.5	929 982	200	SA KRF 50 V2A	919 036	229	VA NH1 280	900 271	102
DV M TT 255 FM	951 315	23	LCS DRC BXT	910 652	174	SA KRF 70 V2A	919 037	229	VC 280 2	900 471	116
DV M TT 2P 255	951 110	24	LCS DRC BXT	910 652	235	SA KRF 94 V2A	919 038	229	VCSD 40 IP65	923 401	246
DV M TT 2P 255 FM	951 115	24	LS 1 50 H DCO	917 977	180	SAK 10 AS V4A	308 403	227	ZAP STW	924 329	111
DV MOD 255	951 001	25	LWL DSI 18M	910 642	45	SAK 11 SN MS	919 011	228			
DV MOD NPE 100	951 100	25	LWL ST DSI	910 641	45	SAK 14 AS V4A	308 404	227			
DV MOD NPE 50	951 050	25	MA SDS M12	723 199	251	SAK 18 AS V4A	308 405	227			
DVCI 1 255	961 200	27				SAK 21 AS V4A	308 406	227			
DVCI 1 255 FM	961 205	27				SAK 26 AS V4A	308 407	227			
DVR 2 BY S 150 FM	928 430	182				SAK 33 AS V4A	308 408	227			
DVR BNC RS485 230	928 440	182									
EB 1 2 1.5	900 460	125									

All information provided in this catalogue about the possible use of our products should be regarded as product information and for advisory purposes only. This information is based on experience and is specified to the best of our knowledge. We do not accept any liability in this respect. This particularly applies to the different conditions of use which are beyond our control. We recommend to check whether the respective DEHN product is suitable for the intended application. Application, use and processing of our products are beyond our control. Therefore, the product is completely subject to the user's responsibility.

Illustrations are not binding.

We accept no liability for misprints, modifications and errors.

* GTIN (EAN-Code)

In this catalogue, you will find the GTIN (EAN code) next to the Part No. For reasons of clarity, only the individual GTIN part is specified. The country and DEHN + SÖHNE code (40 13364) must be put in front of this number.

Abbreviations

PG	Product Group
PU	Packing Unit
SU	Sales Unit (Piece, Meter, Set or Pair)
pc(s)	Piece
m	Meter
Sa	Set
Pa	Pair

Weight Weight per sales unit

Key Words

Product	Page	Product	Page	Product	Page
Accessories for BLITZDUCTOR® XT/XTU/SP/XT Ex (i)	173	DEHNgap C S	83	EXFS Coaxial Connection Box	244
Accessories for DEHNconnect SD2	180	DEHNgate	219	EXFS L / EXFS KU	241
Accessories for DEHNrapid® LSA	191	DEHNguard® 5 kA (NL)	67	FS	223
Accessories for LSA Technology	194	DEHNguard® 1000	100	Impulse Counter	126
Accessories for DEHNpipe	200	DEHNguard® modular	61	Insulating Enclosures	121
BLITZDUCTOR® – Base Parts	158	DEHNguard® modular E (Y)PV SCI 1500	90	Isolating Spark Gaps	240
BLITZDUCTOR® SP	167	DEHNguard® modular for North America	73	ITAK Ex (i)	172
BLITZDUCTOR® VT	183	DEHNguard® modular with integrated Backup Fuse	56	LifeCheck® SPD Test Devices	234
BLITZDUCTOR® VT KKS	185	DEHNguard® modular YPV ... FM	86	Mains Filter	108
BLITZDUCTOR® XT	159	DEHNguard® modular (Y)PV SCI ...	87	NET Protector	206
BLITZDUCTOR® XT Ex (i)	170	DEHNguard® PCB	94	NSM Protector	112
BLITZDUCTOR® XT Ex (i) – Base Part	170	DEHNguard® S	68	Pipe Clamps for Hazardous Areas	247
BLITZDUCTOR® XT – Protection Module	164	DEHNguard® SE CI with integrated Backup Fuse	59	Selection Chart – Industrial Buildings	15
BLITZDUCTOR® XTU	165	DEHNguard® SE DC ... (FM)	84	Selection Chart – Residential Buildings	16-1
Busbars / Modular Wiring System	123	DEHNguard® SE H ... FM	71	Selection Chart – Office and Administration Buildings	16
BUSTector	212	DEHNguard® S ... VA	70	SFL Protector	118
Components for Foundation Earth Electrodes	259	DEHNguard® YPV SCI ... – compact	92	Shield Connection for Cables	229
Components for Ring Equipotential Bonding	259	DEHNpanel	119	Shield Connection on Anchor Bars	226
Condition Monitoring System with LifeCheck® Sensor	231	DEHNpatch	203	Shield Connection on DIN Rails	228
Connecting Clamps	258	DEHNpipe	198	SPD+POP+MCB / POP+MCB	78
DEHNbloc®	48	DEHNprotector	117/210	SPD Test Device	234
DEHNbloc® Maxi	39	DEHNrail modular	104	SPS Protector	109
DEHNbloc® Maxi 1 CI 440/760 FM	40	DEHNrail modular, multipole	106	STC Module	113
DEHNbloc® Maxi 440/760	42	DEHNrapid® LSA – Lightning Current / Surge Arrester	188	UGKF	218
DEHNbloc® Maxi S	44	DEHNrecord Alert	233	VC 280 2	116
DEHNbloc® modular	36	DEHNsafe	110	V NH / VA NH	101
DEHNbloc® modular for North America	38	DEHNsecure modular	46	Voltage-controlled smart decoupling device VCSD	245
DEHNbox	213	DEHNshield®	28	Voltage Limiting Devices	249
DEHNcombo	33	DEHNsignal	45	Wiring Accessories DK / STAK	120
DEHNconnect SD2	177	DEHNsolid	35		
DEHNconnect SD2 Ex (i)	179	DEHNvario	181		
DEHNcord	80	DEHNvenCI	26		
DEHNcube	93	DEHNventil® modular	22		
DEHN Enclosure for Equipotential Bonding	193	DPL 10 G3	192		
DEHNflex	114	Earthing Busbars, single-row / two-row	257		
DEHNgap	51	Enclosure and Protective Conductor Terminal	230		
		Equipotential Busbars	253		
		EXFS 100 / EXFS 100 KU	242		



Surge Protection
Lightning Protection
Safety Equipment
DEHN protects.®

DEHN + SÖHNE
GmbH + Co.KG.

Hans-Dehn-Str. 1
Postfach 1640
92306 Neumarkt
Germany

Phone +49 9181 906 0
Fax +49 9181 906 1100
sales@dehn.de
www.dehn-international.com



For information on our registered trademarks, please visit short link: de.hn/tm.
We accept no liability for technical modifications, misprints and errors. Illustrations are not binding.