

Appendix B – Manufacturer’s CLS Product Information

This form is available in a Microsoft Word version from the ENA’s website.

G100/2 - Form B - Compliance Verification Report for Customer Export or Import Limitation Schemes

This form shall be used by the **Manufacturer** to demonstrate and declare compliance with the requirements of EREC G100. The form can be used in a variety of ways as detailed below:

1. For Fully Type Tested status

The **Manufacturer** can use this form to obtain **Fully Type Tested** status for a **CLS** by registering this completed form with the Energy Networks Association (ENA) Type Test Register.

2. To obtain Type Tested status for a product

The **Manufacturer** can use this form to obtain **Type Tested** status for one or more **Components** which are used in a **CLS** by registering this form with the relevant parts completed with the Energy Networks Association (ENA) Type Test Register.

3. One-off Installation

The **Installer** can use this form to confirm that the **CLS** has been tested to satisfy the requirements of this EREC G100. This form shall be submitted to the **DNO** before commissioning.

A combination of (2) and (3) can be used as required, together with Form C where compliance of the **CLS** is to be demonstrated on site.

Note:

If the **CLS** is **Fully Type Tested** and registered with the Energy Networks Association (ENA) Type Test Register, Form C shall include the **Manufacturer’s** reference number (the Type Test Register system reference), and this form does not need to be submitted.

Where the **CLS** is not registered with the ENA Type Test Register or is not **Fully Type Tested** this form (all or in parts as applicable) shall be completed and provided to the **DNO**, to confirm that the **CLS** has been tested to satisfy all or part of the requirements of this EREC G100.

CLS Designation			
Manufacturer name		SolarEdge Technologies Ltd.	
Address		1 HaMada Street, Herzeliya 4673335, Israel	
Tel	+972-9-9576620	Web site	https://www.solaredge.com/en
Email	Jason.Kirrage@solaredge.com		
Installer’s name			
Address			
Tel		Web site	
Email			

Export/Import capabilities			
Export	Y / N	Import	Y / N
Description of Operation			
EREC G100 section Error! Reference source not found. requires a description of the CLS , and schematic diagram, to be provided to the Customer . Please provide that description and the diagram here.			

The SolarEdge end to end smart energy management solution is based on a centralised concept (Leader Follower) where the G100-2 CLS logic is implemented on the leader INV. The Leader INV is responsible for communication with both generation and SolarEdge smart load devices and as well the meter at the connection point.

SolarEdge CLS Controls & Settings

SolarEdge systems meet EREC G100 version 2 policy requirements through the following high-level control & settings:

1. **SolarEdge Energy Meter (monitoring PoC with the grid):** The SolarEdge meter will ensure that the current is monitored in real-time at the main PoC, ensuring that all potential import / export current flows are captured by the SolarEdge CLS. For multiple incomers, these values are aggregated according to DNO requirements to ensure the requisite import / export limits are managed correctly.
2. **SolarEdge Control Response Times:** The SolarEdge CLS response time are compliant to the G100 2nd amendment time harmonization requirement fixes and will tether the applicable import / export elements to ensure no excursion into State 2 is greater than 15 seconds.
3. **SolarEdge State 1, 2 & 3:** SolarEdge's solution meets the requirements (timing and allowable number of excursions) for state 1, 2 and 3 requirements, as detailed in the G100 2nd amendment policy.
4. **SolarEdge Interrogation & Data:** SolarEdge's solution captures all control, power and current data which is presented in real-time via an HMI (Human Machine Interface) both on site and off site which enables multi-tier extensive data interrogation (by either installer or manufacturer).



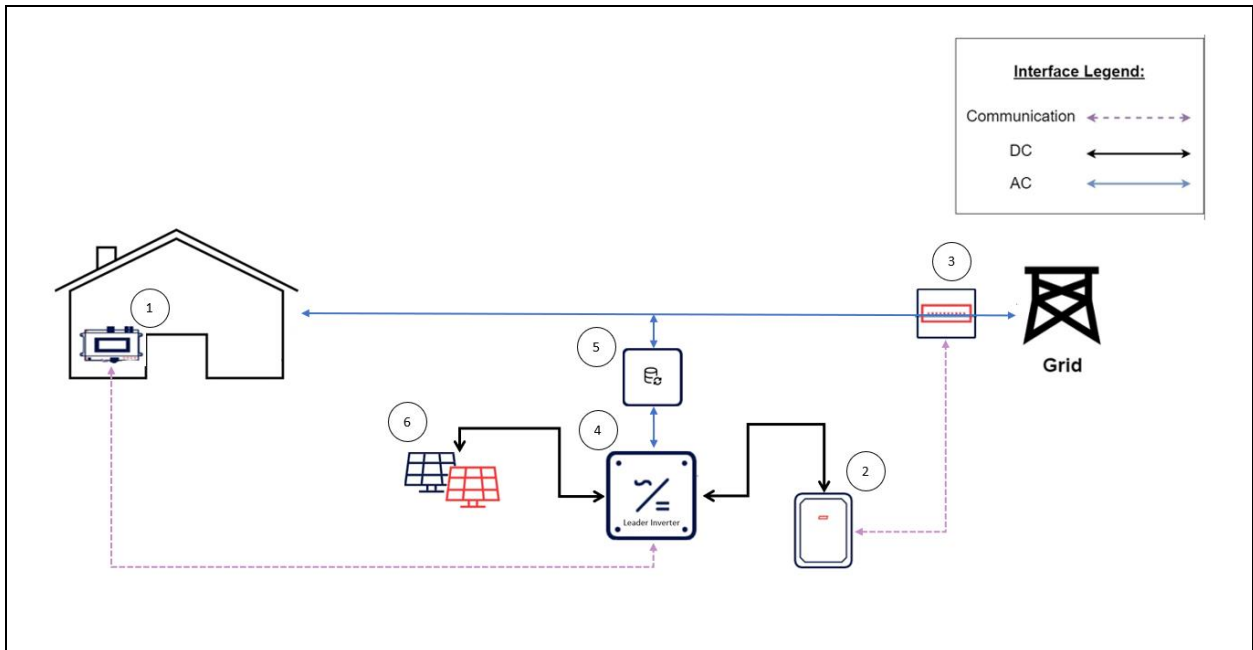

Customer connection scheme

Single inverter

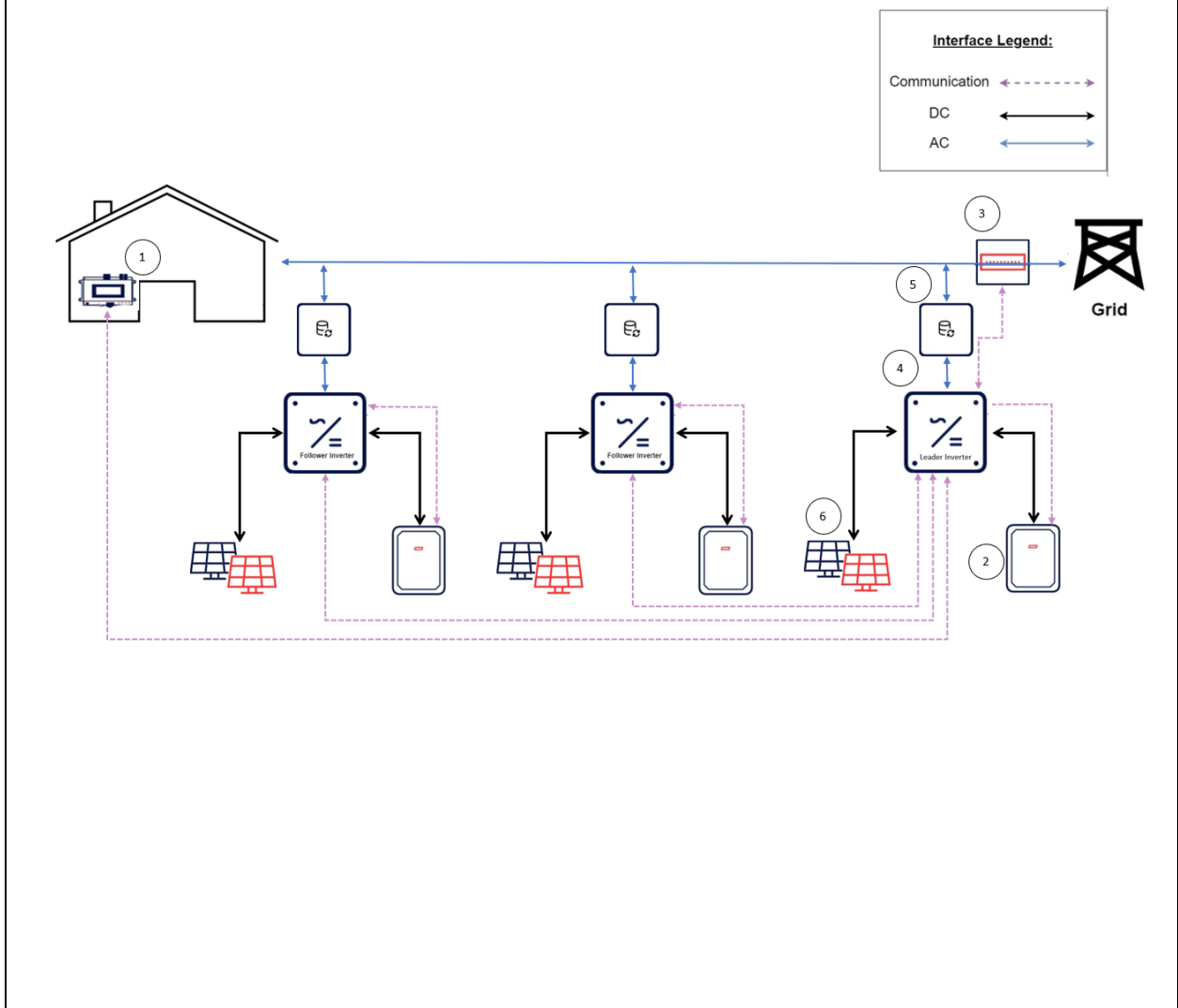

Multi Inverter

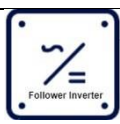

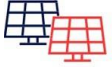
No	Product type	Icon	Product number
1	Smart devices		SMRT-HOT-WTR-30-S1 SMRT-HOT-WTR-50-S1 DCS Plug-in/socket Switch SE-EVK74C00-01
2	Battery		BAT-10K1P
3	Meter		SE-WND-3Y400-MB-K2 SE-MTR-3Y-400V-A
4	Inverter		SE2200H SE3000H SE3500H SE3680H SE4000H SE5000H SE6000H SE8000H SE10000H
5	Backup Interface		BI-EU1P
6	PV		-

Communications Media

Document the provisions made for the use of various communication media, and both the inherent characteristics and the design steps made to ensure security and reliability.

The communication mediums of the CLS can be Wired or Wireless and are registered by the CLS. At the commissioning process the device is registered as a generation/non generation device. The G100-2 logics are also implemented in each of the CLS devices.

1. SolarEdge's solution CLS Internal Communications: All the component parts within the Solution:

CLS system use a combination of:

- a. Hard-wired serial Modbus RTU
 - b. Hard-wired wired communication (LAN)
 - c. Hard-wired serial dedicated protocol (over RS485)
 - d. Dedicated wireless communication (Sub-Giga)
 - e. Standardized wireless communication (Wi-Fi/LTE/Bluetooth)
2. SolarEdge's solution 'Local Network' Communications: All units that constitute the full SolarEdge's solution CLS system are inter-connected by 'hard-wired' and dedicated communications cables. No 3rd party equipment is connected to this network, ensuring that we create a ring-fenced solution.
 3. Remote communications: SolarEdge's solution CLS systems can either communicate remotely via homeowner local LAN or via LTE mobile router installed within the Inverters.

Cyber Security

Confirm that the **Manufacturer** or **Installer** of the **CLS** has provided a statement describing how the **CLS** has been designed to comply with cyber security requirements, as detailed in section.

We SolarEdge Technologies Ltd declare that G100 certified products,

And the variant models to be included in the certification,

Are in compliance with Cyber security requirements in accordance with the standards:

- *ENA Engineering Recommendation G99 Issue 1 Amendment 8 2021*
- ETSI EN 303 645;
- PAS 1879 "Energy smart appliances – Demand side response operation – Code of practice";

Please also refer to the documents provided (SolarEdge declaration_G99_Cyber and Information Security Management - Partner Information Pack).

Power Quality Requirements

Where the **CLS** includes the power electronics that controls generation or loads (as opposed to the power electronics being included in **Devices** that are subject to their own power quality compliance requirements) please submit the harmonic and disturbance information here as required by EREC G5 and EREC P28.

Not applicable to our system as it is not a stand-alone device, and it works as a system.

Fail Safe

CLS internal failure: please submit here the description of the internal **Fail-Safe** design and operation. Please also document how it has been demonstrated, including the non-volatile recording of times and numbers of state 2 operations, and confirm the overall response of the **CLS** to this internal failure.

Fail safe design and operation

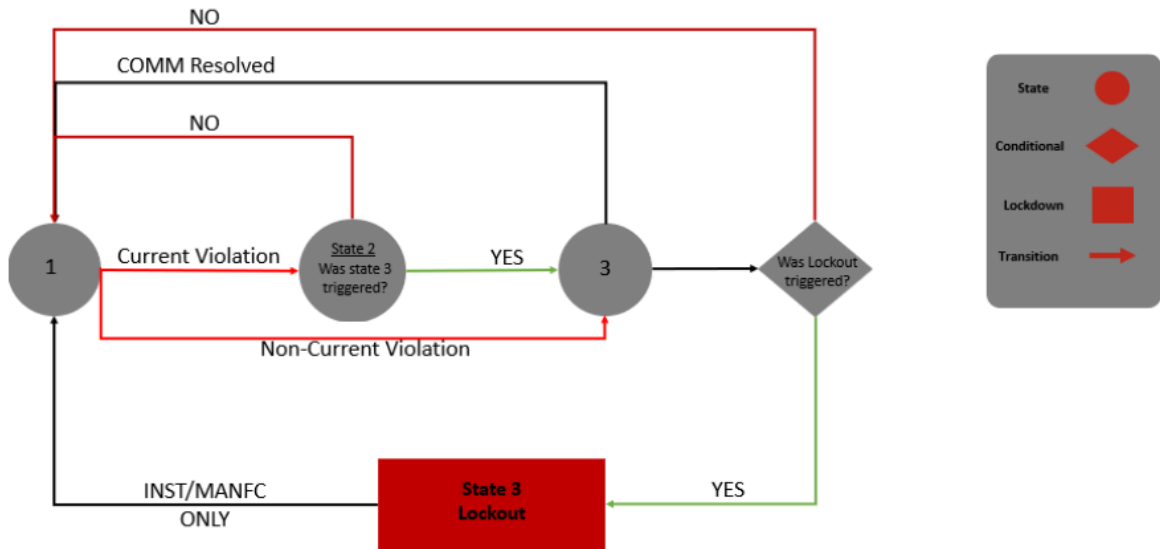

SolarEdge G100 Fail Safe Compliance

SolarEdge G100 CLS was designed with a fail-safe mechanism according to G100 section 4.5. Therefore, the SolarEdge system design ensures that it will limit the imported/exported current at the site to the DNO's agreed limit(s).

All the components in the SolarEdge system are either wired or wireless and are registered by the CLS. At the commissioning process the device is registered as a generation/non generation device.

In the event of a detected failure the system will operate the Fail-safe mechanism by reducing the component generation to zero immediately according to the table above.

State 2 documentation

```

2023-04-03 07:54:36] info cls[1436]: publishing CLS status
2023-04-03 07:54:36] info cls[1436]: cls state = occasional excursion - state 2
2023-04-03 07:54:36] info cls[1436]: importFallback = false
2023-04-03 07:54:36] info cls[1436]: exportFallback = false
2023-04-03 07:54:36] info cls[1436]: multiBrach = false
2023-04-03 07:54:36] info cls[1436]: meterCommError = false
2023-04-03 07:54:36] info cls[1436]: inverterCommError = false
2023-04-03 07:54:36] info cls[1436]: resets performed = 0
2023-04-03 07:54:36] info cls[1436]: -phase 1 state cls_CLSState_OCCASIONAL_EXCURSION - state 2
2023-04-03 07:54:36] info cls[1436]: -phase 1 type 1
2023-04-03 07:54:36] info cls[1436]: -phase 1 current 14.510421
2023-04-03 07:54:36] info cls[1436]: -phase 1 start time 1680508461
2023-04-03 07:54:36] info cls[1436]: -phase 1 duration 15
2023-04-03 07:54:36] info cls[1436]: -----
2023-04-03 07:55:08] info cls[1436]: publishing CLS status
2023-04-03 07:55:08] info cls[1436]: cls state = steady - state 1
2023-04-03 07:55:08] info cls[1436]: importFallback = false
2023-04-03 07:55:08] info cls[1436]: exportFallback = false
2023-04-03 07:55:08] info cls[1436]: multiBrach = false
2023-04-03 07:55:08] info cls[1436]: meterCommError = false
2023-04-03 07:55:08] info cls[1436]: inverterCommError = false
2023-04-03 07:55:08] info cls[1436]: resets performed = 0
2023-04-03 07:55:08] info cls[1436]: -phase 1 state cls_CLSState_STEADY - state 1
2023-04-03 07:55:08] info cls[1436]: -phase 1 type 1
2023-04-03 07:55:08] info cls[1436]: -phase 1 current 14.510421
2023-04-03 07:55:08] info cls[1436]: -phase 1 start time 1680508461
2023-04-03 07:55:08] info cls[1436]: -phase 1 duration 47
2023-04-03 07:55:08] info cls[1436]: -----

```

Communication and power supply failures between **Components** and **Devices**. Please document here compliance with EREC G100 section **Error! Reference source not found.**.

Component/Device number/description	Communication failure test	Power supply failure test
Meter SE-WND-3Y400-MB-K2 SE-MTR-3Y-400V-A	PASS	PASS
Inverter SE2200H, SE3000H, SE3500H, SE3680H, SE4000H, SE5000H, SE6000H, SE8000H, SE10000.	PASS	PASS
Heater Controller SMRT-HOT-WTR-30-S1 SMRT-HOT-WTR-50-S1	PASS	PASS
Smart load controller DCS	PASS	PASS
Battery BAT-10K1P	PASS	PASS

Operational Tests						
In accordance with EREC G100 section Error! Reference source not found. undertake the tests A to D to confirm correct operation in state 1 and state 2, that transition into state 3 occurs as required, and that behaviour in state 3 is also as required.						
Test A						
Nominal Export Limit (for type tests this will be at maximum, minimum and one intermediate setting) in Amp:						10A
Nominal Import Limit (for type tests this will be at maximum, minimum and one intermediate setting) in Amp:						10A
No	Starting level	Step value	CLS register s change in level?	CLS and/or Component and/or Device initiates correct response of $\geq 5\%$?	Duration of step in test	Correct state 1/ state 2 operation
1	Below export limit (EL)	105% of EL	Yes	Yes	58s	1 > 2 > 1
2	Below export limit (EL)	110% of EL	Yes	Yes	58s	1 > 2 > 1
3	Below export limit (EL)	120% of EL	Yes	Yes	58s	1 > 2 > 1
4	Below Import limit (IL)	105% of IL	Yes	Yes	58s	1 > 2 > 1
5	Below Import limit (IL)	105% of IL	Yes	Yes	58s	1 > 2 > 1
6	Below Import limit (IL)	105% of IL	Yes	Yes	58s	1 > 2 > 1

Test B						
Nominal Export Limit:						8A
Nominal Import Limit						8A
No	Starting level	Step value	CLS register change in level?	CLS and/or Component and/or Device initiates correct response of $\geq 5\%$?	Duration of step in test	Correct state 3 operation
7	Below export limit (EL)	105% of EL	Yes	Yes	62s	1>2>3
8	Below export limit (EL)	105% of EL	Yes	Yes	62s	1>2>3

State 3 Reset
<p>These tests are to demonstrate compliance with section EREC G100 Error! Reference source not found..</p> <p>Please document how the reset from state 3 to state 1 has been demonstrated. Please include how the reset is achieved.</p> <p>Please confirm that for CLSs to be installed in Domestic installations three (3) resets causes lockout or that for non-domestic installations lockout can only be reset after four hours. Please explain how lockout is reset.</p>
<ol style="list-style-type: none"> 1. System state is "State 3 - Lock-Out". 2. Expert investigation has ended successfully. 3. CLS changes system state to "State 1 - Normal Operation" and sends commands to Load & Generation devices. 4. CLS Clears all G.100 related events from its memory due to investigations. 5. Devices receive the command and enter their Normal Operational Mode. 6. CLS logs the state change. 7. CLS sends generated event to "Cloud". 8. CLS sends and alert to a User Interface that the system is in "State 1 - Normal Operation".