

OBM-LoRa-223



Owen Brothers
Metering UK LTD

www.owen-brothers.com

RS485 - LoRa Long Range Wireless Transceiver



Supported Protocols
LoRa-PMAC LoRa-Radio LoRa-WAN

PRODUCT OVERVIEW



General Description

The Owen Brothers OBM-LoRa-223 Long Range Wireless Transceiver allows you to connect RS485 Modbus RTU devices over distances where it is impractical or impossible to run cables. The transceiver modules can connect to multiple devices and multiple transceiver modules.

Ideal for Electric, Gas & Water Meters, Inverters, Temperature Sensors, Fuel Sensors, Environment Sensors and much more.

Supported Serial Port Settings:	Baud Rates	1200, 2400, 4800, 9600 bps.
	Parity	Even, Odd or None.
	Stop Bits	1 or 2

Specification

Operating Voltage	AC85~420Vac
Static Power	0.5W@220Vac
Working Frequency	50Hz±10Hz
Wired Communication Port	RS-485/Modbus-RTU
Wireless Standard	LoRa WAN, LoRa Radio, LoRa PMAC
Frequency Range	428~438MHz
Transmit Power	+19dBm Max
Receive Sensitivity	SF10: ≤ -132dBm
Operating Temperature	-25°C : +70°C
Storage Temperature	-40°C : +85°C
Mechanical Dimensions	90.5 x 35.6 x 60.7 mm (LxWxH)

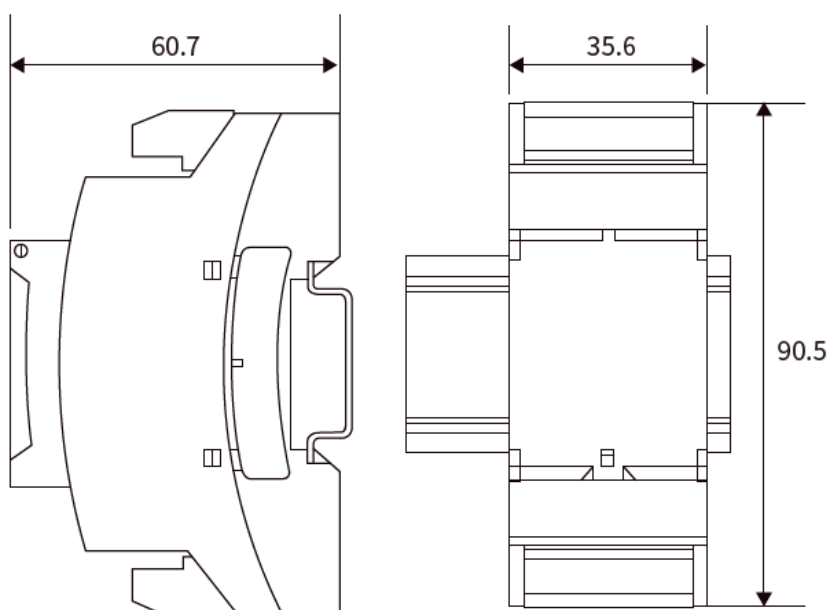

Connection Terminals

L	AC Live
N	AC Neutral
YO	Not Used
N.C	Not Used
RF	Antenna
A	RS-485 (A)
B	RS-485 (B)

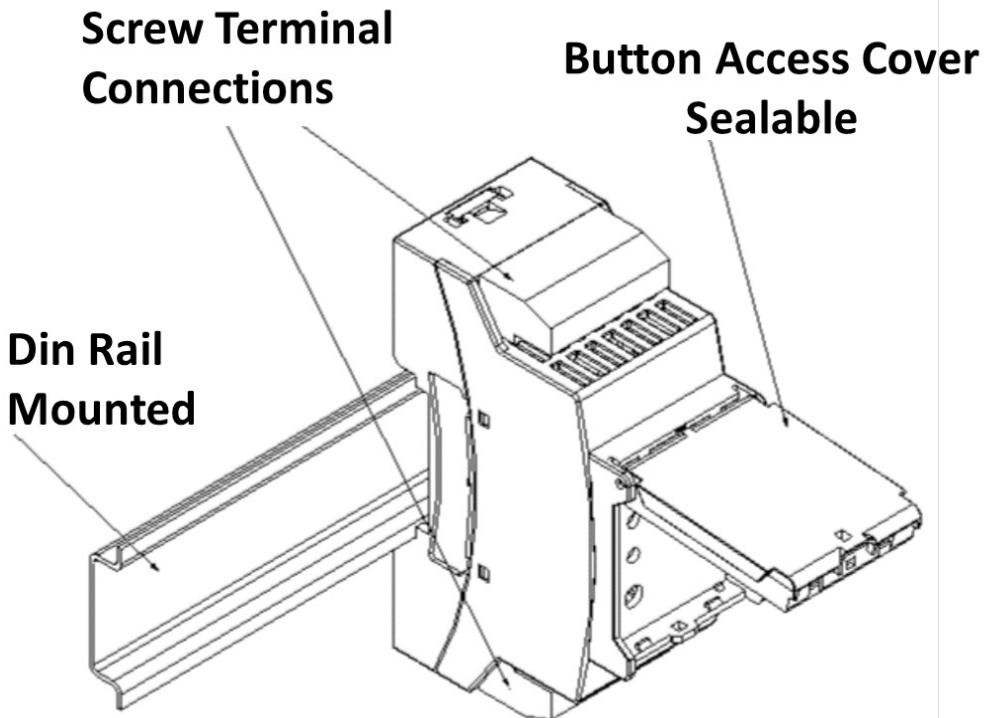

Quick Setup Guide

LoRa Radio Mode

The simplest mode to use out of the box with no configuration required by pc.

Main Display in LoRa Radio Mode.

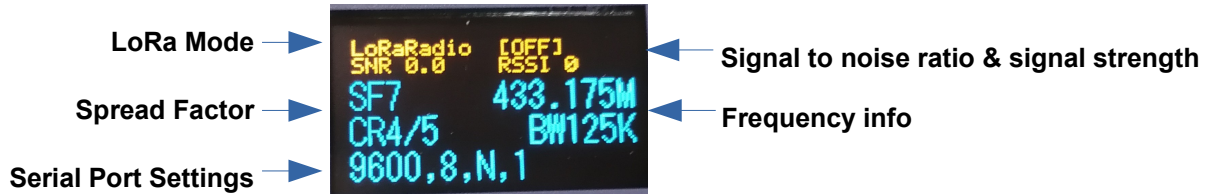

To Select LoRa Radio Mode

- Press and hold the FUNC button to display the Main Menu.
- Press the FUNC button repeatedly to scroll to System.
- Press ENTER button to select System Setting menu.
- Press ENTER button repeatedly until shows LoRa Radio.
- Press the FUNC button to return to Main Menu.
- Press FUNC button to scroll to Reboot
- Press ENTER button to reboot device to update settings.

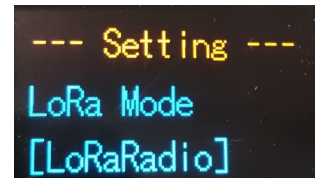
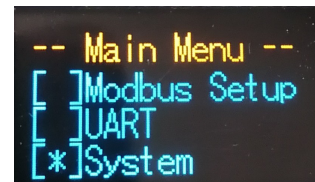

Change LoRa Radio Frequency

- Press and hold the FUNC button to display the Main Menu.
- Press the FUNC button repeatedly to scroll to Frequency.
- Press ENTER button to select Frequency Setting menu.
- Press Func button to select digit to change.
- Press the ENTER button to increase digit.
- Press FUNC button to scroll to end and return to Main Menu.
- Press FUNC button to scroll to Reboot
- Press ENTER button to reboot device to update settings.
- Modules must be on same frequency to communicate with each other.

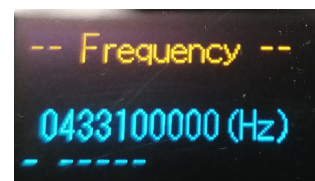
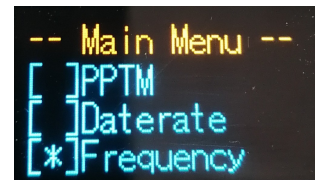

Change Serial Port Settings

- Press and hold the FUNC button to display the Main Menu.
- Press the FUNC button repeatedly to scroll to UART.
- Press ENTER button to select UART Setting menu.
- Press the ENTER button repeatedly to scroll to desired Baud Rate.
- Press FUNC button for Parity.sub menu.
- Press the ENTER button repeatedly to scroll to desired Parity.
- Press FUNC button to return to Main Menu.
- Press FUNC button to scroll to Reboot
- Press ENTER button to reboot device to update settings.

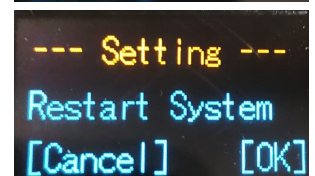
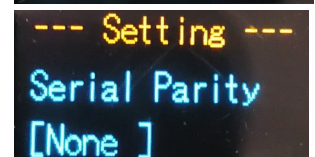
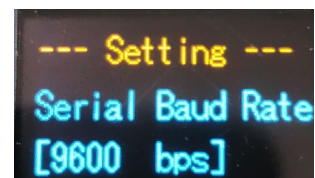

LoRa PMAC Mode

PMAC Mode is a private radio-based MAC protocol

Features Software CRC check and CSMA (Conflict Avoidance)

LoRa PMAC Communication Modes

- Unicast addressing (one-to-one)
- Multicast addressing (one-to-many)
- Broadcast (one pair all)

To Select LoRa PMAC Mode

- Press and hold the FUNC button to display the Main Menu.
- Press the FUNC button repeatedly to scroll to System.
- Press ENTER button to select System Setting menu.
- Press ENTER button repeatedly until shows LoRa PMAC.
- Press the FUNC button to return to Main Menu.
- Press FUNC button to scroll to Reboot
- Press ENTER button to reboot device to update settings.

Change LoRa PMAC Channel

- Press and hold the FUNC button to display the Main Menu.
- Press the FUNC button repeatedly to scroll to Channel.
- Press ENTER button to select Channel Setting menu.
- Press the ENTER button to increase channel number.
- Press FUNC button to return to Main Menu.
- Press FUNC button to scroll to Reboot
- Press ENTER button to reboot device to update settings.
- Modules must be on same channel to communicate with each other..

View LoRa PMAC Settings

- Press and hold the FUNC button to display the Main Menu.
- Press the FUNC button repeatedly to scroll to LoRaPMAC.
- Press ENTER button to view LoRa PMAC ID's.
- Press FUNC button to view LoRaPMAC Mode.
- Press FUNC button to return to Main Menu.
- Modules must be on same Channel and Network ID

OBM-LoRa-223 Configuration Software

To change LoRa PMAC settings and more please use OBM-LoRa-223 Configuration software.

Main Display in LoRa PMAC Mode.

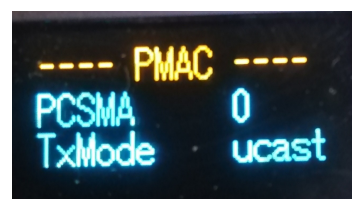
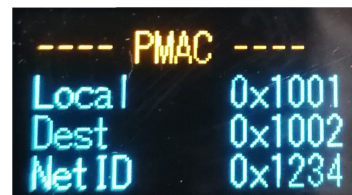
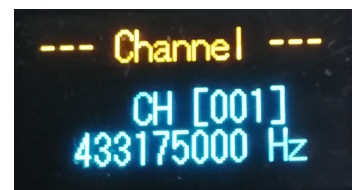
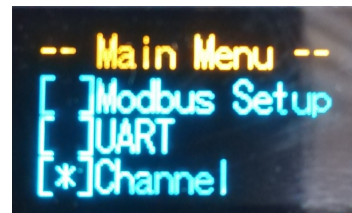
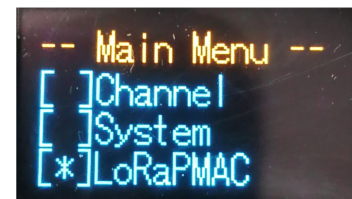
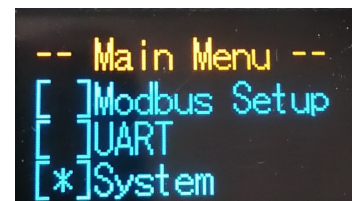
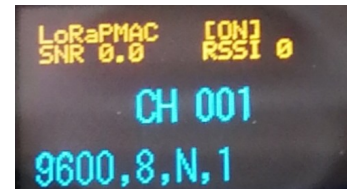

LoRa WAN Mode

- LoRaWAN can be configured with the OBM-LoRa-223 Configuration Software.
- Owen Brothers Metering recommends using LoRa Radio or PMAC modes and does not provide technical support support for LoRa WAN mode.

Part Name	Harmful Substance					
	Lead	HG	Cadmium	Hexavalent Chromium	Polybrominated Biphenyls	Polybrominated Diphenyl Ethers
	(Pb)	(Hg)	(Cd)	(Cr6)	(PBB)	(PBDE)
Circuit board	0	0	0	0	0	0
Shell	0	0	0	0	0	0
Metal Parts	0	0	0	0	0	0
Internal Wire	0	0	0	0	0	0
Other accessories	0	0	0	0	0	0

This form is prepared according to the provisions of SJ/T 11364

O: Indicates that the content of the hazardous substance in all homogeneous materials of the part is specified in GB/T 26572

X: Indicates that the content of the harmful substance in at least one homogeneous material of the part exceeds GB/T 26572 limit requirements.



Owen Brothers
Metering UK LTD

www.owen-brothers.com

Contact us:

Owen Brothers Metering UK LTD
Unit 6 Glen Trading Estate
Wellyhole Street
Oldham
OL4 3BF

Sales@owen-brothers.com
Support@owen-brothers.com

(+44) 0161 624 6211

www.owen-brothers.com