

# GSE IN-ROOF SYSTEM™

BIPV system for photovoltaic panels

## Installation guide

V 2.0

### 1 Calculation of PV array dimensions

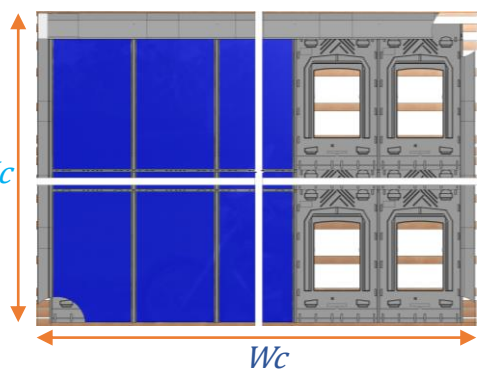

$$Hc \text{ (mm)} = (\text{Height Ref.} + \text{graduation}) \times \text{nb. rows} + 310$$

$$Wc \text{ (mm)} = (\text{Width Ref.} + 36.5) \times \text{nb. columns} + 310$$

*Height Ref.* / *Width Ref.* : depends on selected frame (see table below)

*Graduation* : depends on the length of the module (Height of the module – Height Ref of the GSE frame)

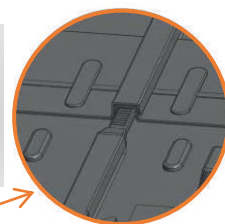

GSE frames - PORTRAIT

Height Ref	1580	1575	1575	1575	1640	1640	1686	1710	1710	1710	1710	1710	1710	1710	1710	1710	1710	1710	1710	1710
Width Ref	808	1046	1053	1082	992	1001	1016	995	1000	1005	1010	1020	1025	1030	1040	1045	1050	1055		

GSE frames - LANDSCAPE

Height Ref	1082	1082	808	992	992	992	992	992	992	992*	992*	1020	1020	1020	1020	1020	1020	1020	1020	1020	1020
Width Ref	1559	1575	1580	1640	1650	1660	1670	1675	1680	1686	1700	1665	1675	1680	1685	1690	1695	1700	1705	1720	1740

### 2 Support battens of the mounting system

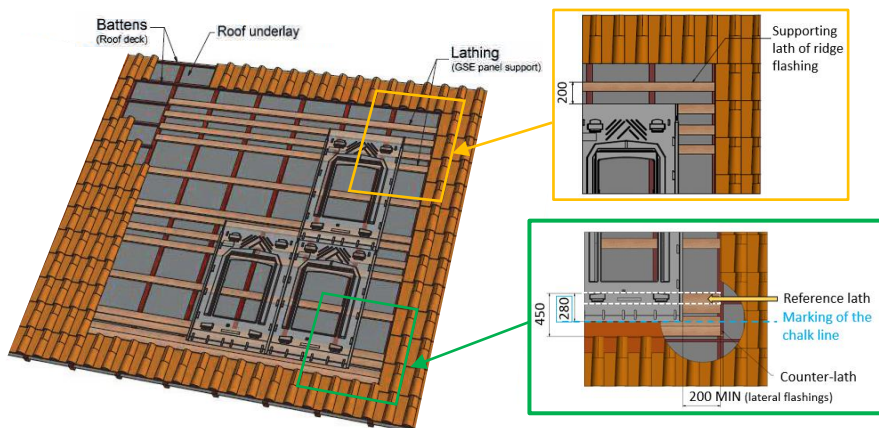
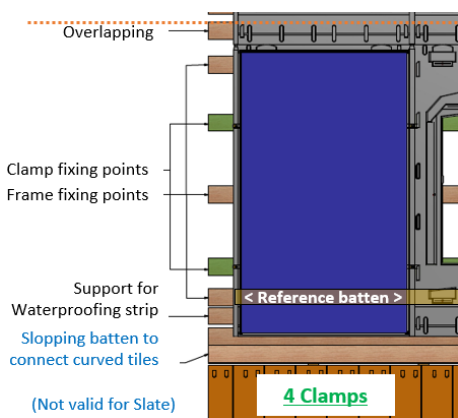

The sections of the support battens are determined according to climatic loads. Use roof battens only if the section is suitable to support climatic loads and if they are positioned according to the GSE battening plan (refer to the online documents)

**Recommended batten section** :27x100 (use minimum 25x50)

For other dimensions of sections, refer to the paragraphs 2.3.2 and 2.4.2 of the installation manual.

### 3 Junction to the lower roofing elements

#### A Junction in the middle of the roof

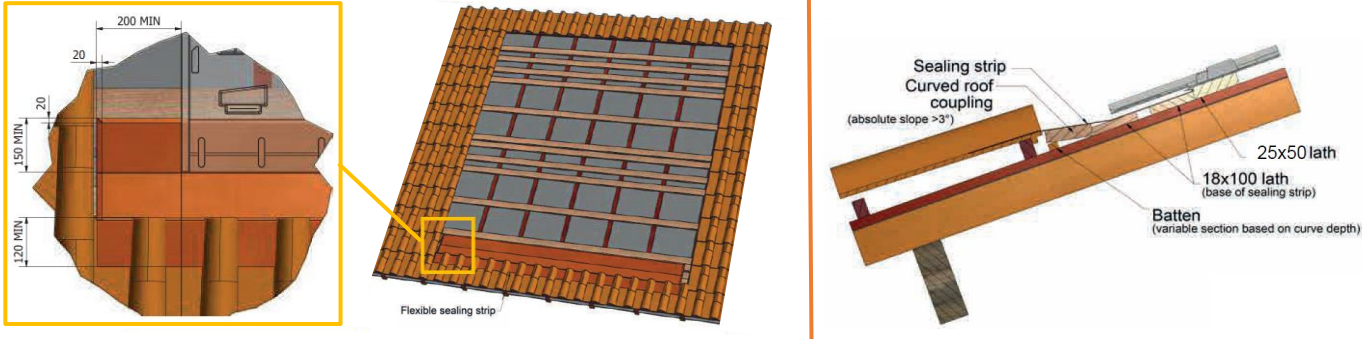

Laying of the waterproofing strip on:



**TOP:** the butyl strip of 2cm is laid under the frames

**BOTTOM:** the butyl strip of 10cm is laid on the tiles



Slate:

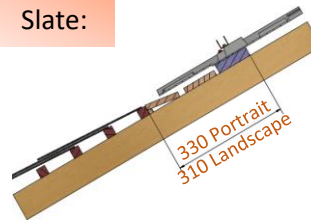

Other tiles:

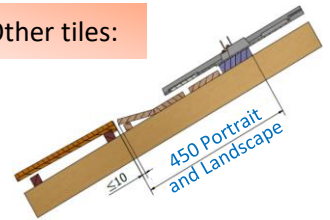

#### B Junction to the gutter

When installing all the way to the eaves, the PV field can be connected directly to the gutter with a waterproofing strip or a drip flashing.

*N.B.: the drip flashing isn't included in the GSE kit*

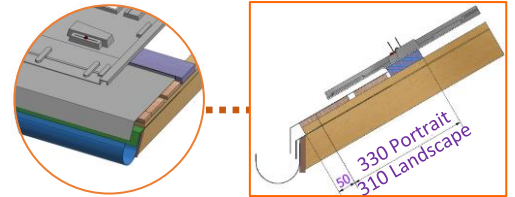

### 4 GSE frames grid

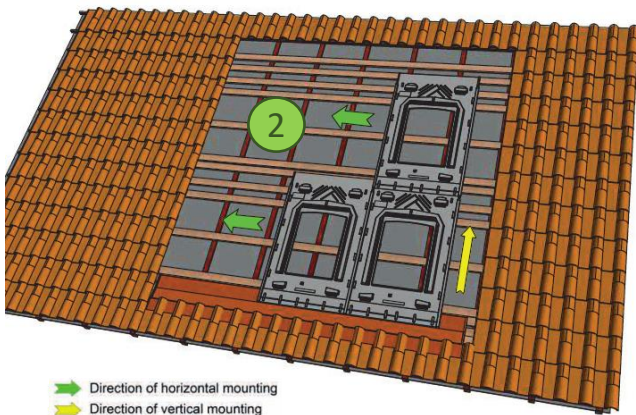

- 1 Fix the 1st frame through the 2 central fixing points
- 2 Assemble and fix the other frames
- 3 Pre-drill & fix the 4 other fixing points

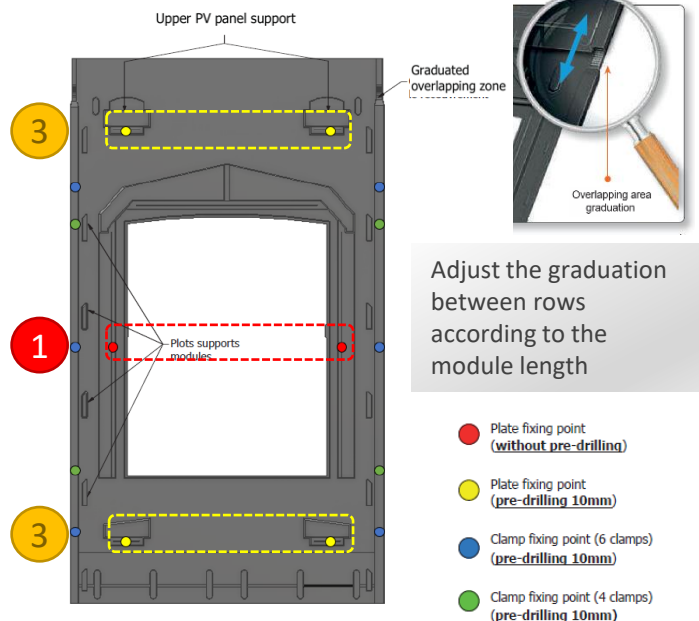

Adjust the graduation between rows according to the module length



**Warning: Do not screw too deep into the frame**

5 Lateral flashings

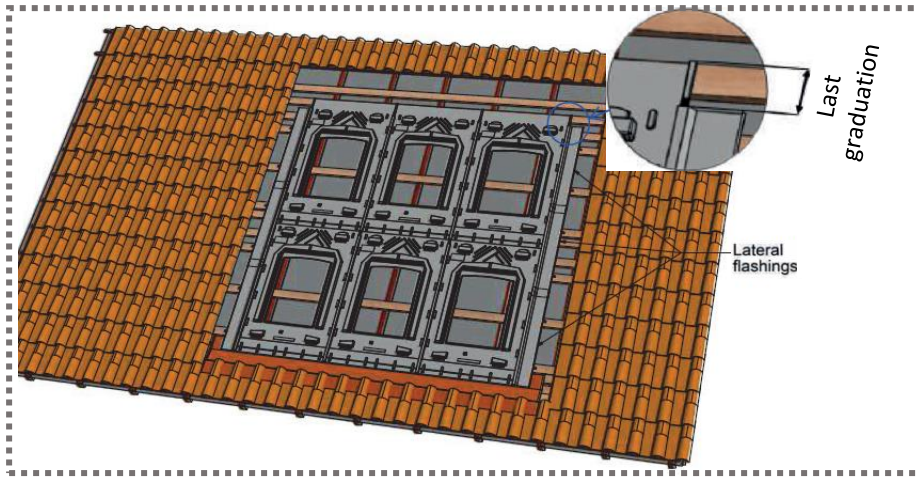

- 1 Place the wedges beneath the ridges of the frames
- 2 Flashings are placed on each other (150mm overlapping)
- 3 Straight to the clamps position, pre-drill through the flashing, plastic frame and wedge.

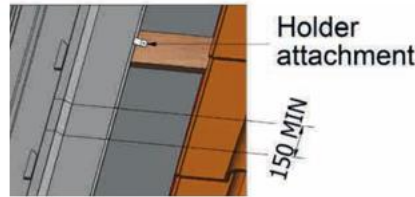
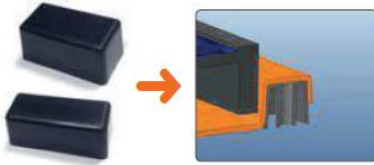

6 Solar panels

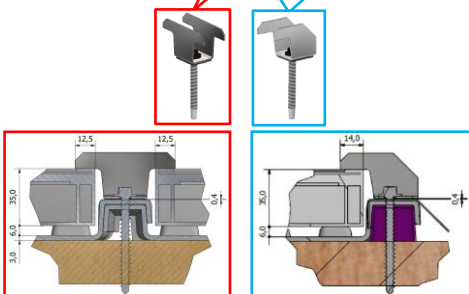
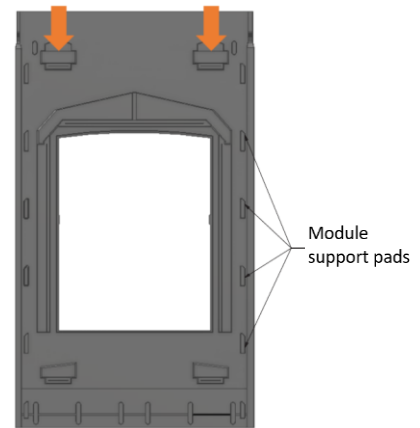
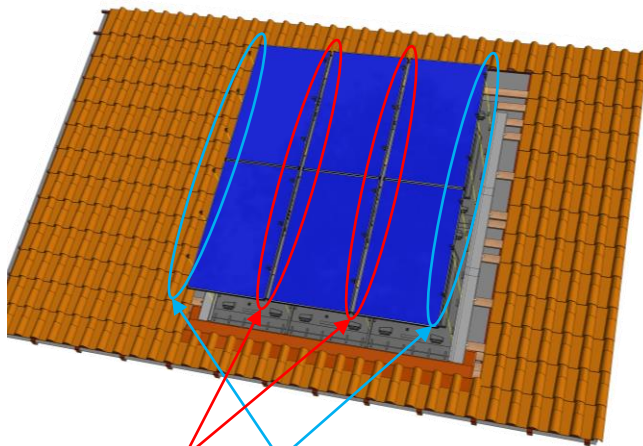

The module is maintained with the upper protrusions and must rest on the pads

Put EPDM foam beneath the clamps and pre-drill it with the screw

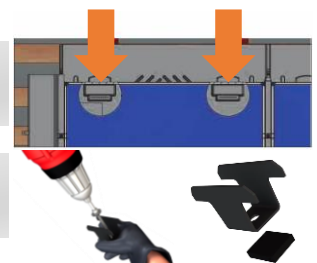

## 7 Top/corner flashings

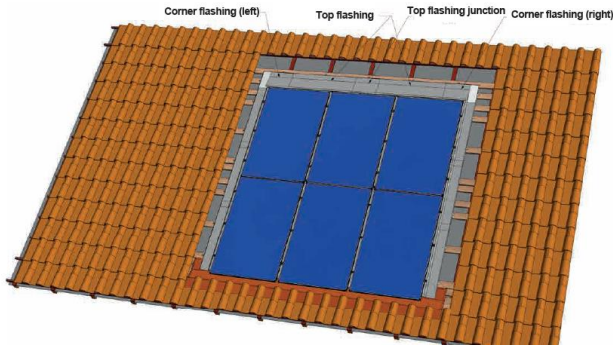

Position the attach angles and the top flashings so that it fits the module thickness. Make cuts on the attach angle at the position of the GSE panel corrugations.

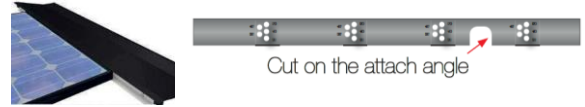

Assemble the top flashing with the junction and the corner pieces.

Apply a seal joint at each junction between 2 pieces

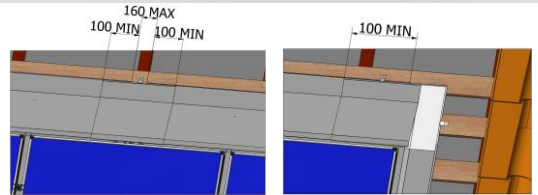
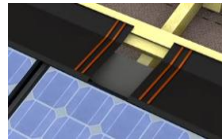

If needed, you will have to cut the corner flashings according to the GSE frame selected and the thickness of the module as defined in the following table:

Module thickness	30-34 mm	35-39 mm	40 et +
Frames 2012	Incompatible*	Needed cut	No cut needed
Frames 2020	Needed cut	No cut needed	Incompatible*

\* Laying of a waterproofing strip on top of the PV field

Follow the 3 steps below to cut the corner flashings:

1

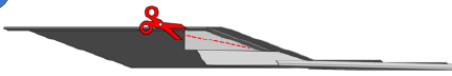

Cut the corner flashing in two distinct pieces

2

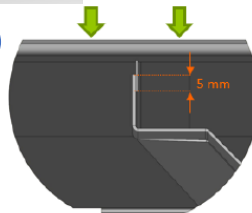

Adjust the height of the corner flashing by overlapping the two pieces

3

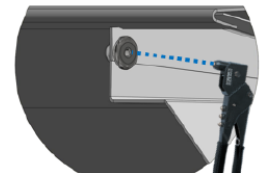

Once the height adjusted, drill the overlapped pieces with a 4,5mm drill bit and fix it with a rivet

## 8 Connection with roofing tiles

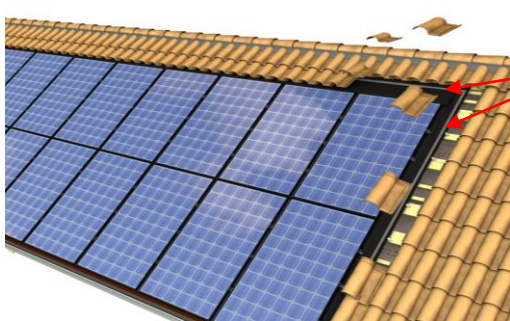

Place the pre-compressed foam on the top and lateral flashings

Cut the tiles if necessary. Double tiles can be used on lateral sides.

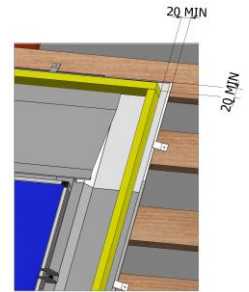

### Top of the PV field

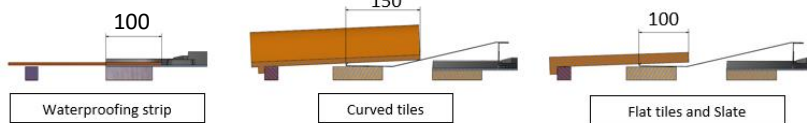

### Lateral PV field

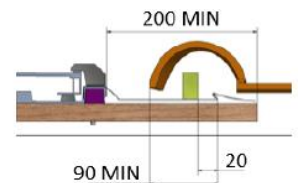

Technical support available :  
Mon – Fri : 09:30 – 18:00

Whatsapp: +33 7.64.49.97.86  
E-Mail: [technical.support@gseintegration.com](mailto:technical.support@gseintegration.com)



Installation video Installation manual