

GSE IN-ROOF SYSTEM™

Battening plans for
Landscape and Portrait frames

V 2.1



MADE IN FRANCE

Battening Plan – Table of contents

TABLE OF CONTENTS

<u>POSITION OF THE REFERENCE BATTEN.....</u>	<u>2</u>
<u>BATTENING PLANS FOR LANDSCAPE FRAMES</u>	<u>3</u>
<u>H808 – 4 Clamps.....</u>	<u>4</u>
<u>H808 – 6 Clamps.....</u>	<u>5</u>
<u>H992 – H1016 – 4 Clamps</u>	<u>6</u>
<u>H992 – H1016 – 6 Clamps</u>	<u>7</u>
<u>H1020 – 4 Clamps.....</u>	<u>8</u>
<u>H1020 – 6 Clamps.....</u>	<u>9</u>
<u>H1082 – 4 Clamps.....</u>	<u>10</u>
<u>H1082 – 6 Clamps.....</u>	<u>11</u>
<u>BATTENING PLANS FOR PORTRAIT FRAMES.....</u>	<u>12</u>
<u>H1575 – 4 Clamps.....</u>	<u>13</u>
<u>H1575 – 6 Clamps.....</u>	<u>14</u>
<u>H1580 – 4 Clamps.....</u>	<u>15</u>
<u>H1580 – 6 Clamps.....</u>	<u>16</u>
<u>H1640 – 4 Clamps.....</u>	<u>17</u>
<u>H1640 – 6 Clamps.....</u>	<u>18</u>
<u>H1686 – 4 Clamps.....</u>	<u>19</u>
<u>H1686 – 6 Clamps.....</u>	<u>20</u>
<u>H1710 – 4 Clamps.....</u>	<u>21</u>
<u>H1710 – 6 Clamps.....</u>	<u>22</u>
<u>H1650 – 4 Clamps.....</u>	<u>23</u>
<u>H1840 – 4 Clamps.....</u>	<u>24</u>

Battening Plan – Position of the reference batten

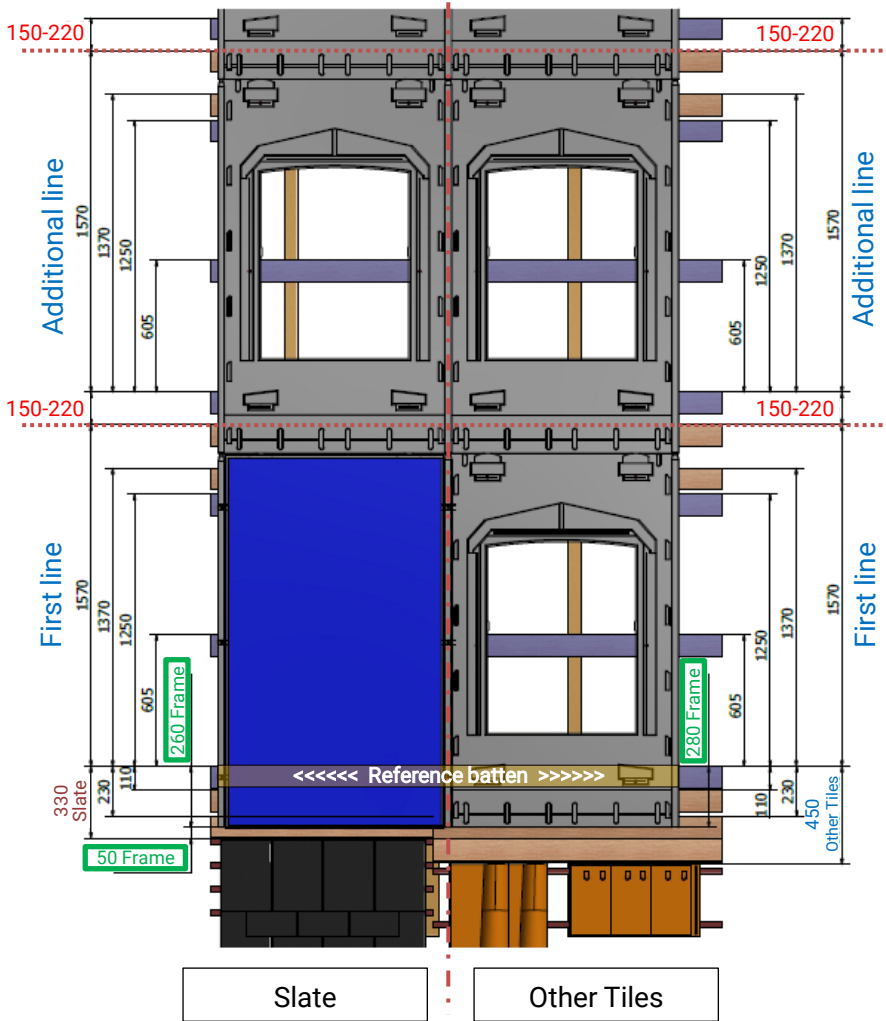

- The reference batten is positioned first, with specific distance from the tiles at the bottom of the photovoltaic field.
- For slates, do not add the batten at the bottom of the field.
- For the other tiles, add the additional sloping batten in order to perform coupling with the curved tiles.
- For the gutter, add an additional batten of 50 mm at the bottom to move up the PV field.
- Position the first frame with the with help of the dimensions highlighted in green.

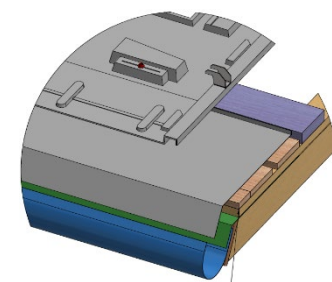
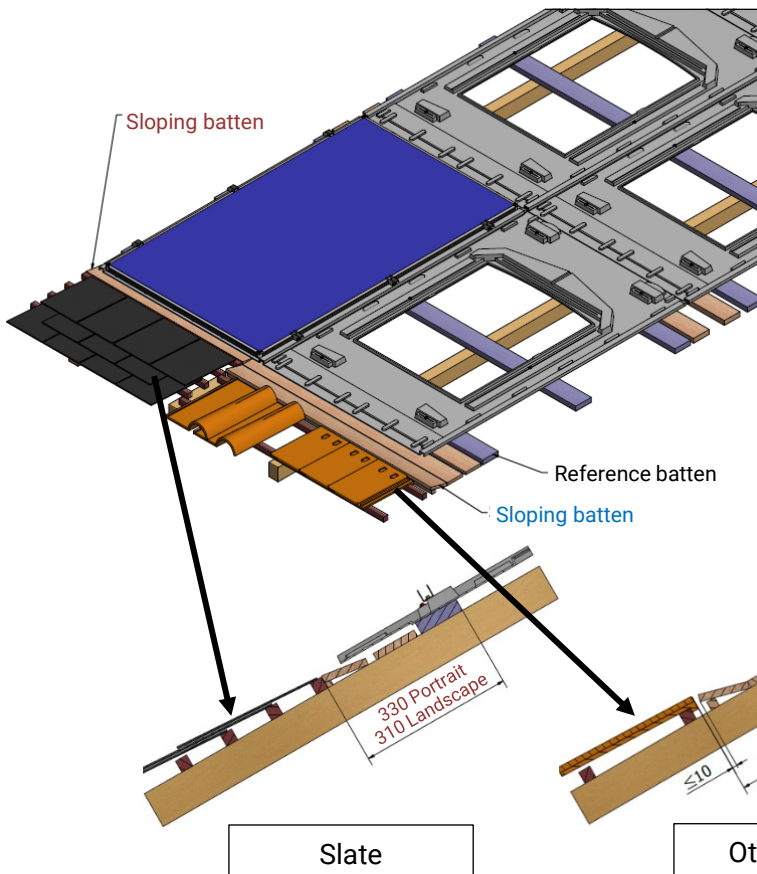

Additional batten of mm at the gutter

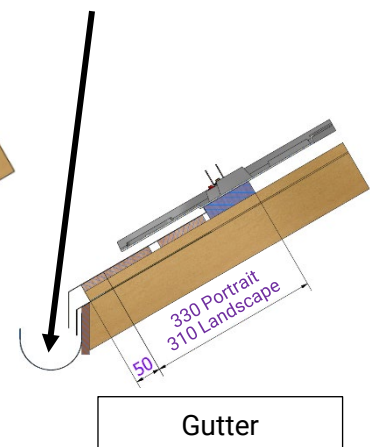



Battening plans
for Landscape frames

Battening Plan – Landscape Frame H808

H808 – 4 Clamps GSE frame references: 1580/808

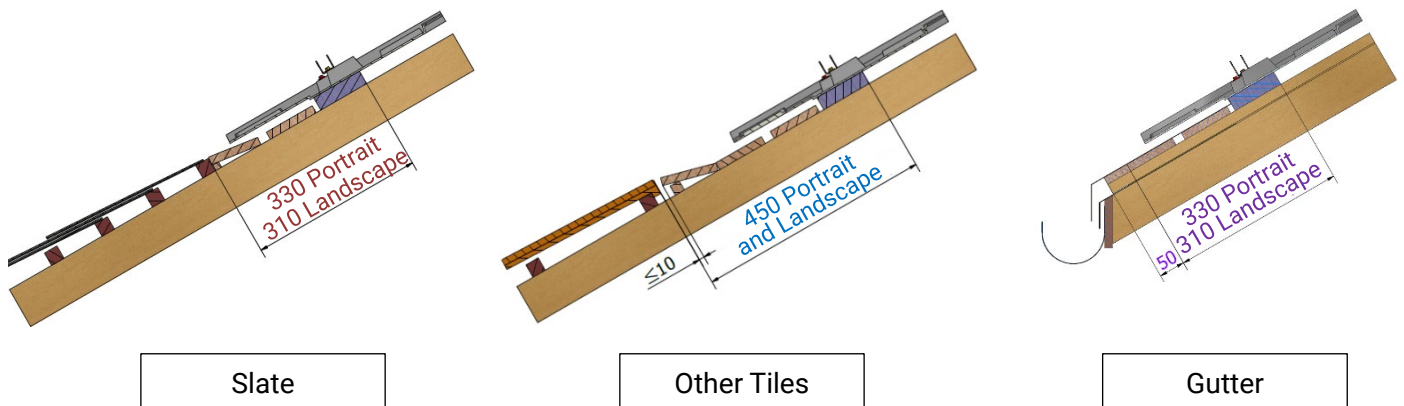
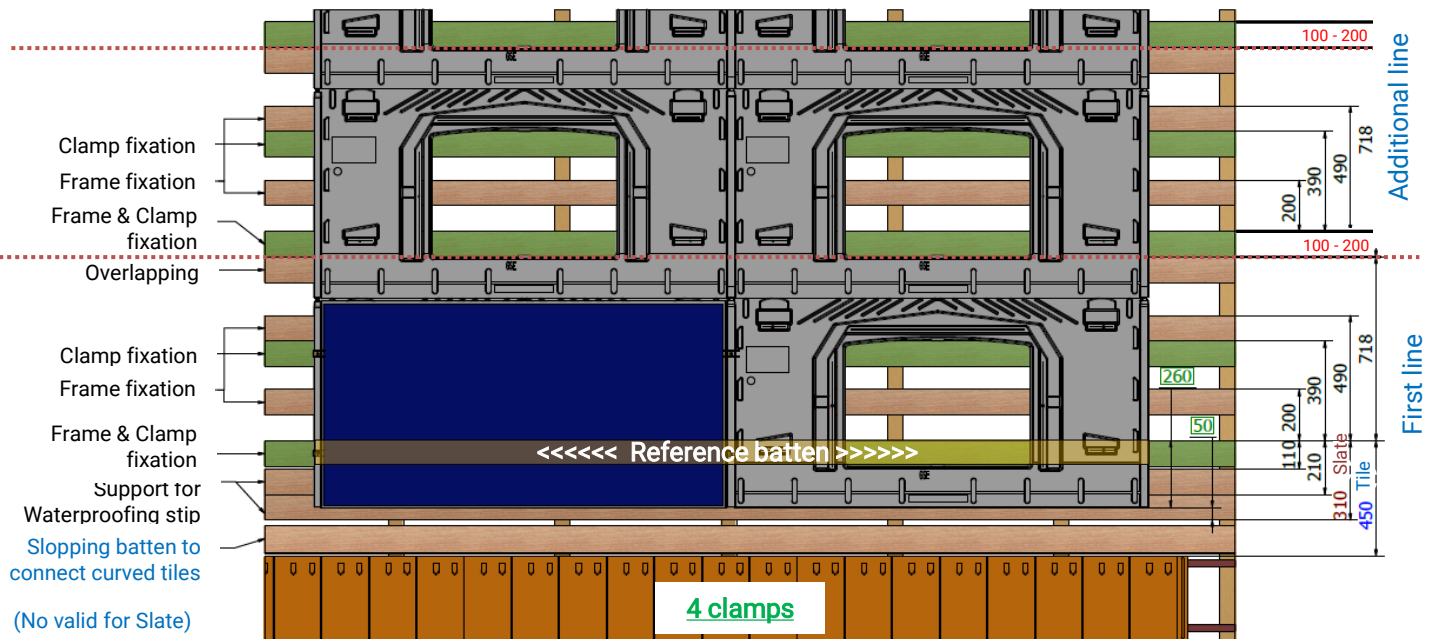

➤ **Batten width**¹ = 100mm

N.B.: the red dimension has to be adjusted according to the panel length (mm)

Panel length	First line	Additional line	Adjustment
≤808	450 (or 310) + 718	100 + 718	0
818	450 (or 310) + 718	110 + 718	10
828	450 (or 310) + 718	120 + 718	20
838	450 (or 310) + 718	130 + 718	30
848	450 (or 310) + 718	140 + 718	40
858	450 (or 310) + 718	150 + 718	50
868	450 (or 310) + 718	160 + 718	60
878	450 (or 310) + 718	170 + 718	70
888	450 (or 310) + 718	180 + 718	80
898	450 (or 310) + 718	190 + 718	90
908	450 (or 310) + 718	200 + 718	100

(1) The dimension of the batten must comply with the Eurocode specifications according to the wind and snow zones of the Country. Recommendations are given in the installation manual of the GSE In-Roof System. For any questions, please, contact the technical support of GSE Integration.

Battening Plan – Landscape Frame H808

H808 – 6 Clamps GSE frame references: 1580/808

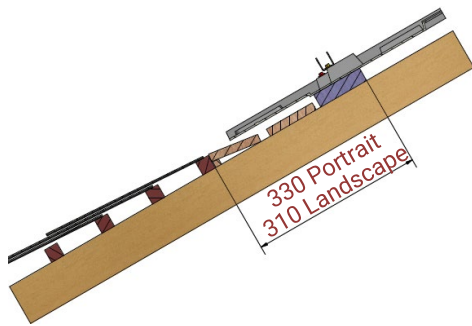
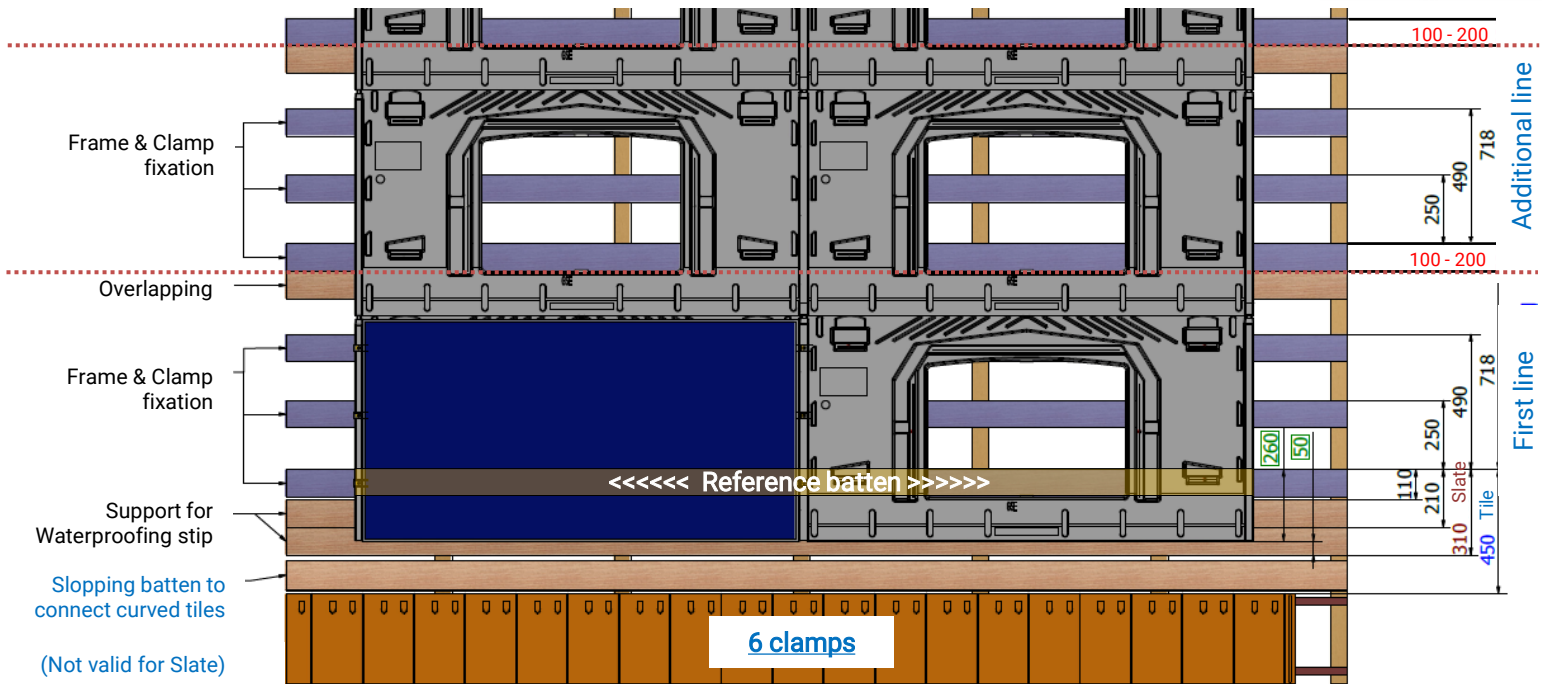

Slate

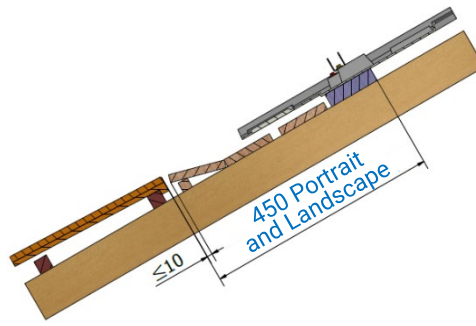

Other Tiles

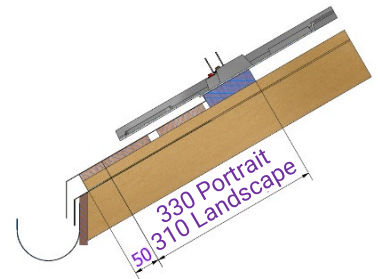

Gutter

➤ **Batten width**¹ = 100mm

N.B.: the red dimension has to be adjusted according to the panel length (mm)

Panel length	First line	Additional line	Adjustment
≤808	450 (or 310) + 718	100 + 718	0
818	450 (or 310) + 718	110 + 718	10
828	450 (or 310) + 718	120 + 718	20
838	450 (or 310) + 718	130 + 718	30
848	450 (or 310) + 718	140 + 718	40
858	450 (or 310) + 718	150 + 718	50
868	450 (or 310) + 718	160 + 718	60
878	450 (or 310) + 718	170 + 718	70
888	450 (or 310) + 718	180 + 718	80
898	450 (or 310) + 718	190 + 718	90
908	450 (or 310) + 718	200 + 718	100

(1) The dimension of the batten must comply with the Eurocode specifications according to the wind and snow zones of the Country. Recommendations are given in the installation manual of the GSE In-Roof System. For any questions, please, contact the technical support of GSE Integration.

Battening Plan – Landscape Frame H992 - H1016

H992 – H1016 – 4 Clamps GSE frame references:

1640/992 - 1650/992 - 1660/992 – 1670/992 - 1675/992 - 1680/992 - 1686/1016 - 1700/1016

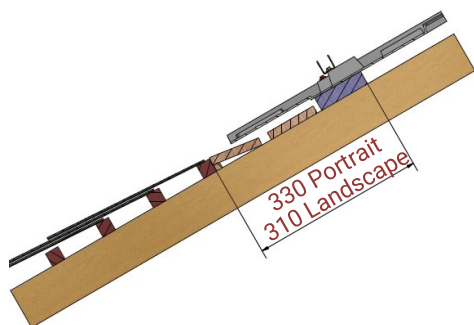
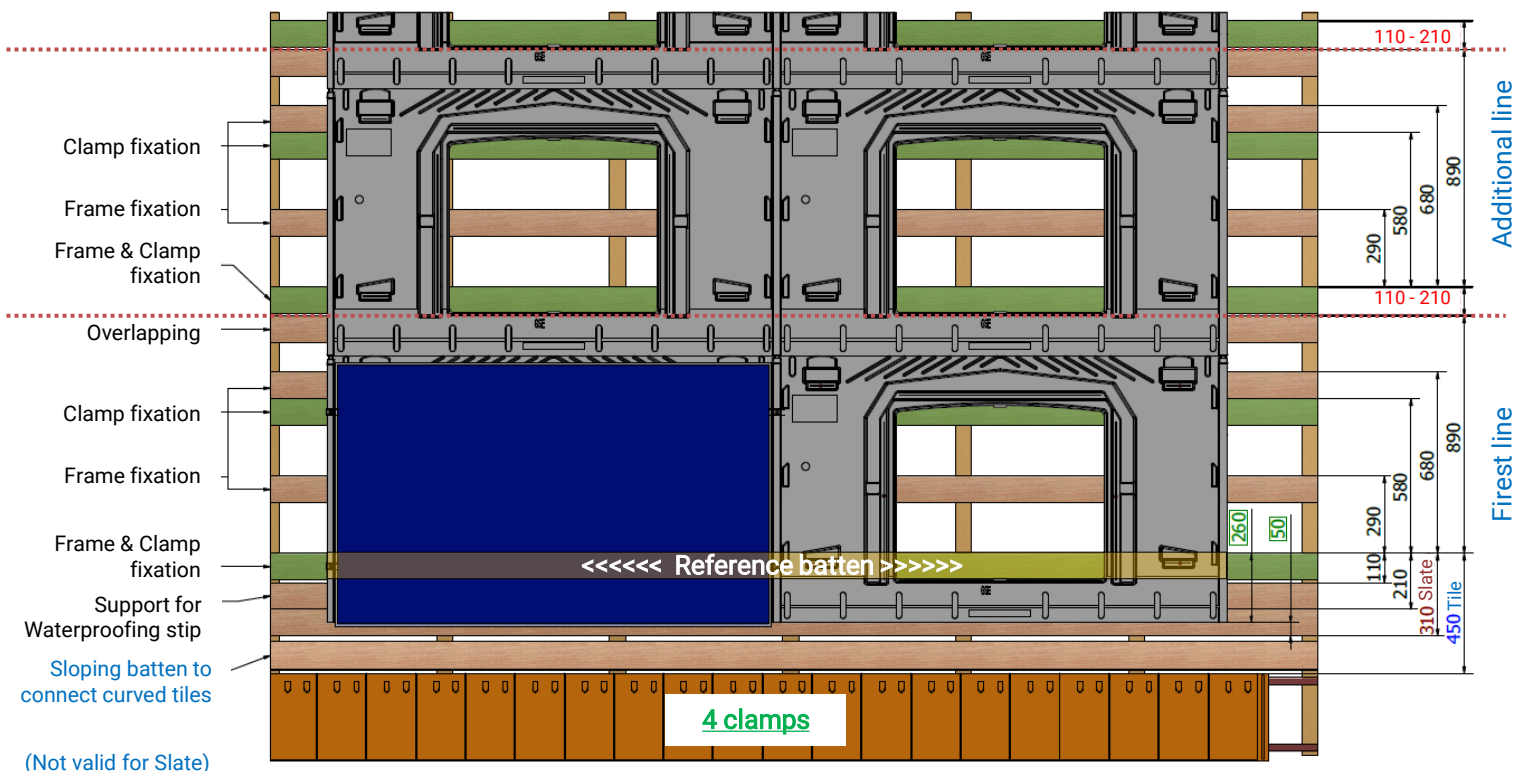

Slate

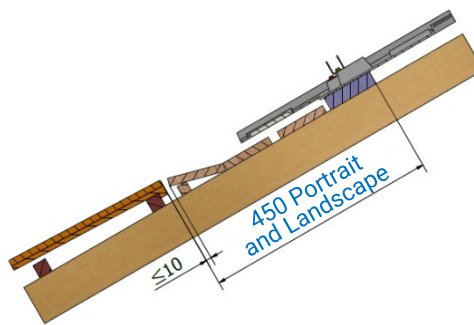

Other Tiles

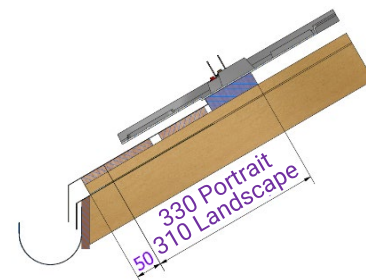

Gutter

➤ **Batten width¹ = 100mm**

N.B.: the red dimension has to be adjusted according to the panel length (mm)

Panel length	First line	Additional line	Adjustment
≤992	450 (or 310) + 890	110 + 890	0
1002	450 (or 310) + 890	120 + 890	10
1012	450 (or 310) + 890	130 + 890	20
1022	450 (or 310) + 890	140 + 890	30
1032	450 (or 310) + 890	150 + 890	40
1042	450 (or 310) + 890	160 + 890	50
1052	450 (or 310) + 890	170 + 890	60
1062	450 (or 310) + 890	180 + 890	70
1072	450 (or 310) + 890	190 + 890	80
1082	450 (or 310) + 890	200 + 890	90
1092	450 (or 310) + 890	210 + 890	100

(1) The dimension of the batten must comply with the Eurocode specifications according to the wind and snow zones of the Country. Recommendations are given in the installation manual of the GSE In-Roof System. For any questions, please, contact the technical support of GSE Integration.

Battening Plan – Landscape Frame H992 - H1016

H992 – H1016 – 6 Clamps GSE frame references:

1640/992 - 1650/992 - 1660/992 – 1670/992 - 1675/992 - 1680/992 - 1686/1016 - 1700/1016

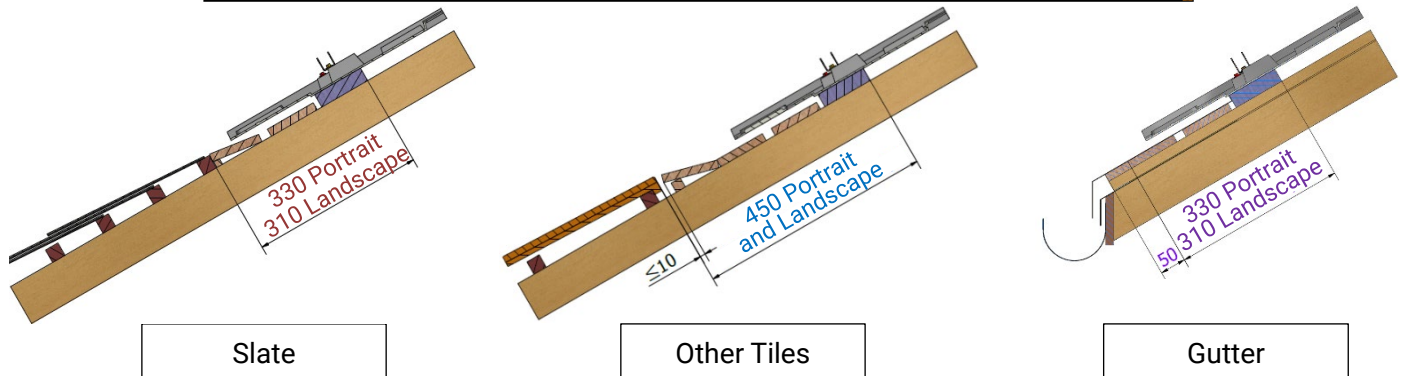
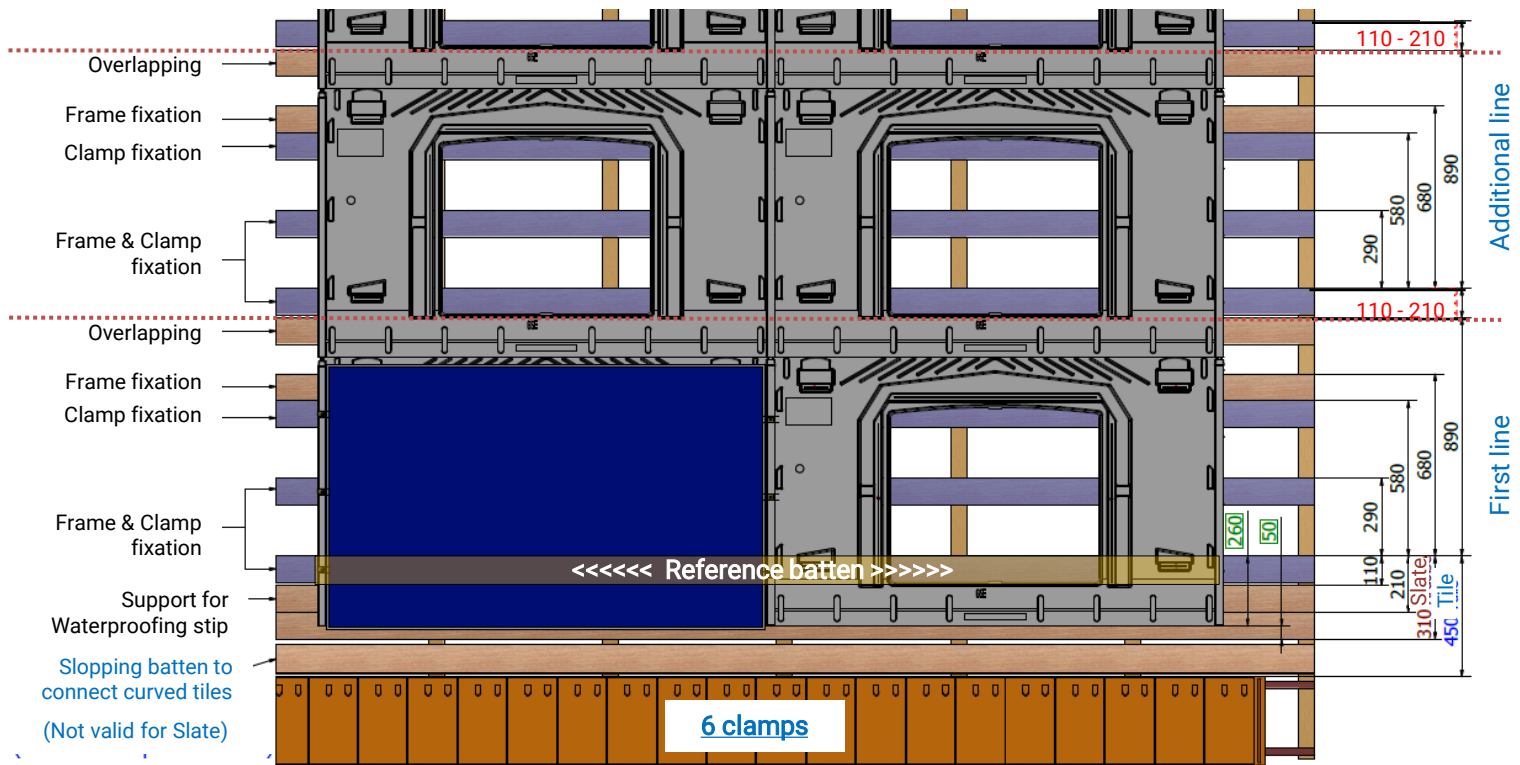

➤ **Batten width**¹ = 100mm

N.B.: the red dimension has to be adjusted according to the panel length (mm)

Panel length	First line	Additional line	Adjustment
≤992	450 (or 310) + 890	110 + 890	0
1002	450 (or 310) + 890	120 + 890	10
1012	450 (or 310) + 890	130 + 890	20
1022	450 (or 310) + 890	140 + 890	30
1032	450 (or 310) + 890	150 + 890	40
1042	450 (or 310) + 890	160 + 890	50
1052	450 (or 310) + 890	170 + 890	60
1062	450 (or 310) + 890	180 + 890	70
1072	450 (or 310) + 890	190 + 890	80
1082	450 (or 310) + 890	200 + 890	90
1092	450 (or 310) + 890	210 + 890	100

(1) The dimension of the batten must comply with the Eurocode specifications according to the wind and snow zones of the Country. Recommendations are given in the installation manual of the GSE In-Roof System. For any questions, please, contact the technical support of GSE Integration.

Battening Plan – Landscape Frame H1020

H1020 – 4 Clamps GSE frame references:

1665/1020 - 1675/1020 - 1680/1020 - 1685/1020 - 1690/1020 - 1695/1020 - 1700/1020 - 1705/1020 - 1720/1020 - 1740/1020

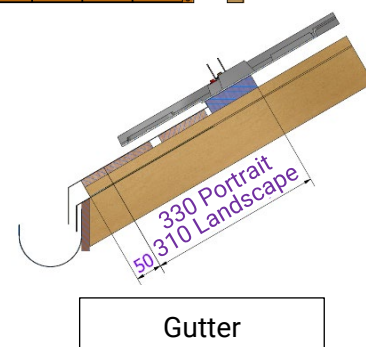
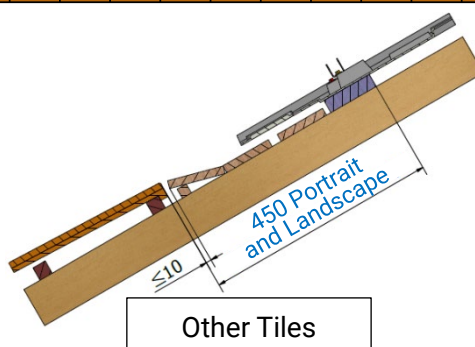
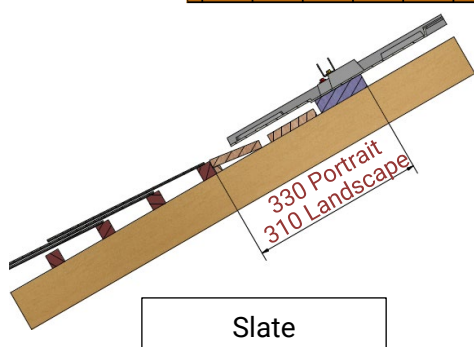
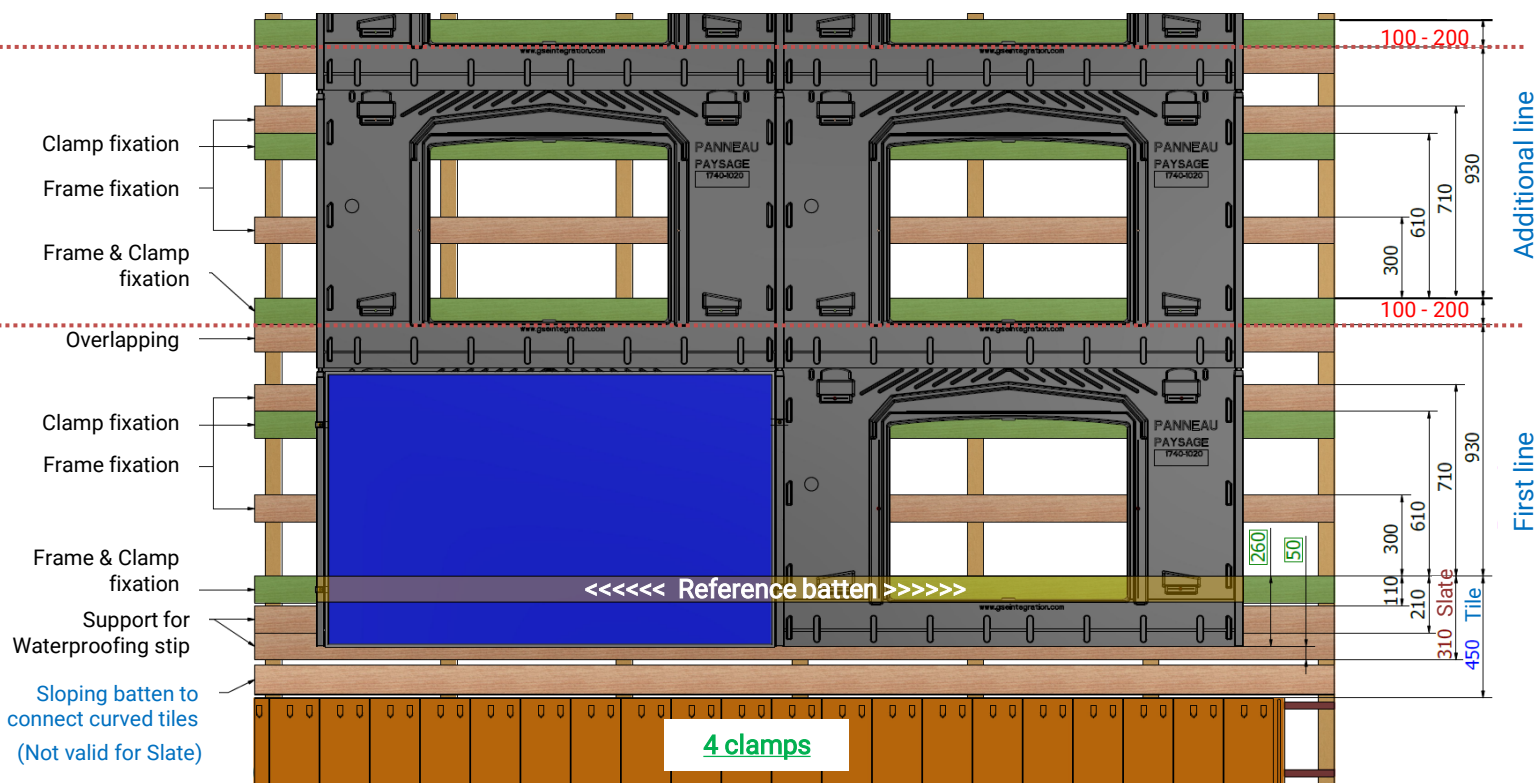

➤ **Batten width**¹ = 100mm

N.B.: the red dimension has to be adjusted according to the panel length (mm)

Panel length	First line	Additional line	Adjustment
≤1020	450 (or 310) + 930	100 + 930	0
1030	450 (or 310) + 930	110 + 930	10
1040	450 (or 310) + 930	120 + 930	20
1050	450 (or 310) + 930	130 + 930	30
1060	450 (or 310) + 930	140 + 930	40
1070	450 (or 310) + 930	150 + 930	50
1080	450 (or 310) + 930	160 + 930	60
1090	450 (or 310) + 930	170 + 930	70
1100	450 (or 310) + 930	180 + 930	80
1110	450 (or 310) + 930	190 + 930	90
1120	450 (or 310) + 930	200 + 930	100

(1) The dimension of the batten must comply with the Eurocode specifications according to the wind and snow zones of the Country. Recommendations are given in the installation manual of the GSE In-Roof System. For any questions, please, contact the technical support of GSE Integration.

Battening Plan – Landscape Frame H1020

H1020 – 6 Clamps GSE frame references:

1665/1020 - 1675/1020 - 1680/1020 - 1685/1020 - 1690/1020 - 1695/1020 - 1700/1020 - 1705/1020 - 1720/1020 - 1740/1020

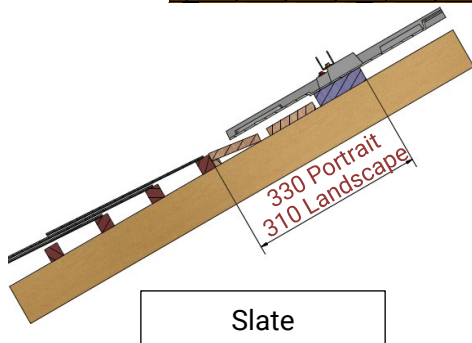

Slate

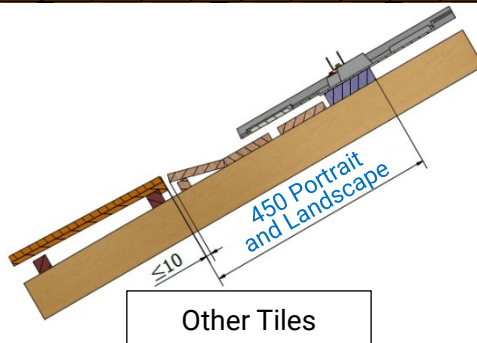

Other Tiles

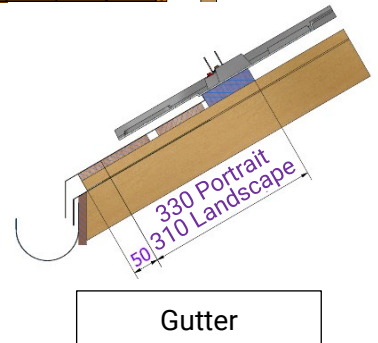

Gutter

➤ **Batten width**¹ = 100mm

N.B.: the red dimension has to be adjusted according to the panel length (mm)

Panel length	First line	Additional line	Adjustment
≤1020	450 (or 310) + 930	100 + 930	0
1030	450 (or 310) + 930	110 + 930	10
1040	450 (or 310) + 930	120 + 930	20
1050	450 (or 310) + 930	130 + 930	30
1060	450 (or 310) + 930	140 + 930	40
1070	450 (or 310) + 930	150 + 930	50
1080	450 (or 310) + 930	160 + 930	60
1090	450 (or 310) + 930	170 + 930	70
1100	450 (or 310) + 930	180 + 930	80
1110	450 (or 310) + 930	190 + 930	90
1120	450 (or 310) + 930	200 + 930	100

(1) The dimension of the batten must comply with the Eurocode specifications according to the wind and snow zones of the Country. Recommendations are given in the installation manual of the GSE In-Roof System. For any questions, please, contact the technical support of GSE Integration.

Battening Plan – Landscape Frame H1082

H1082 – 4 Clamps GSE frame references: 1559/1046 - 1575/1082

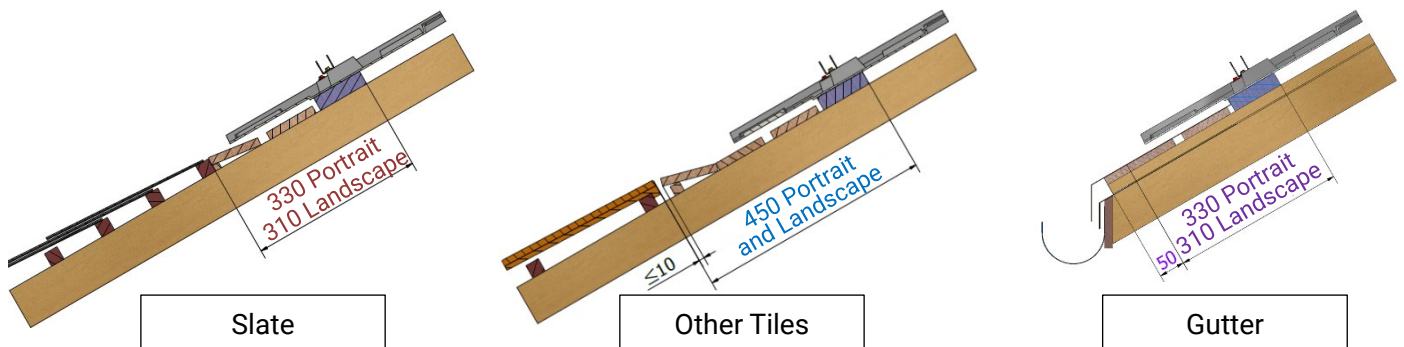
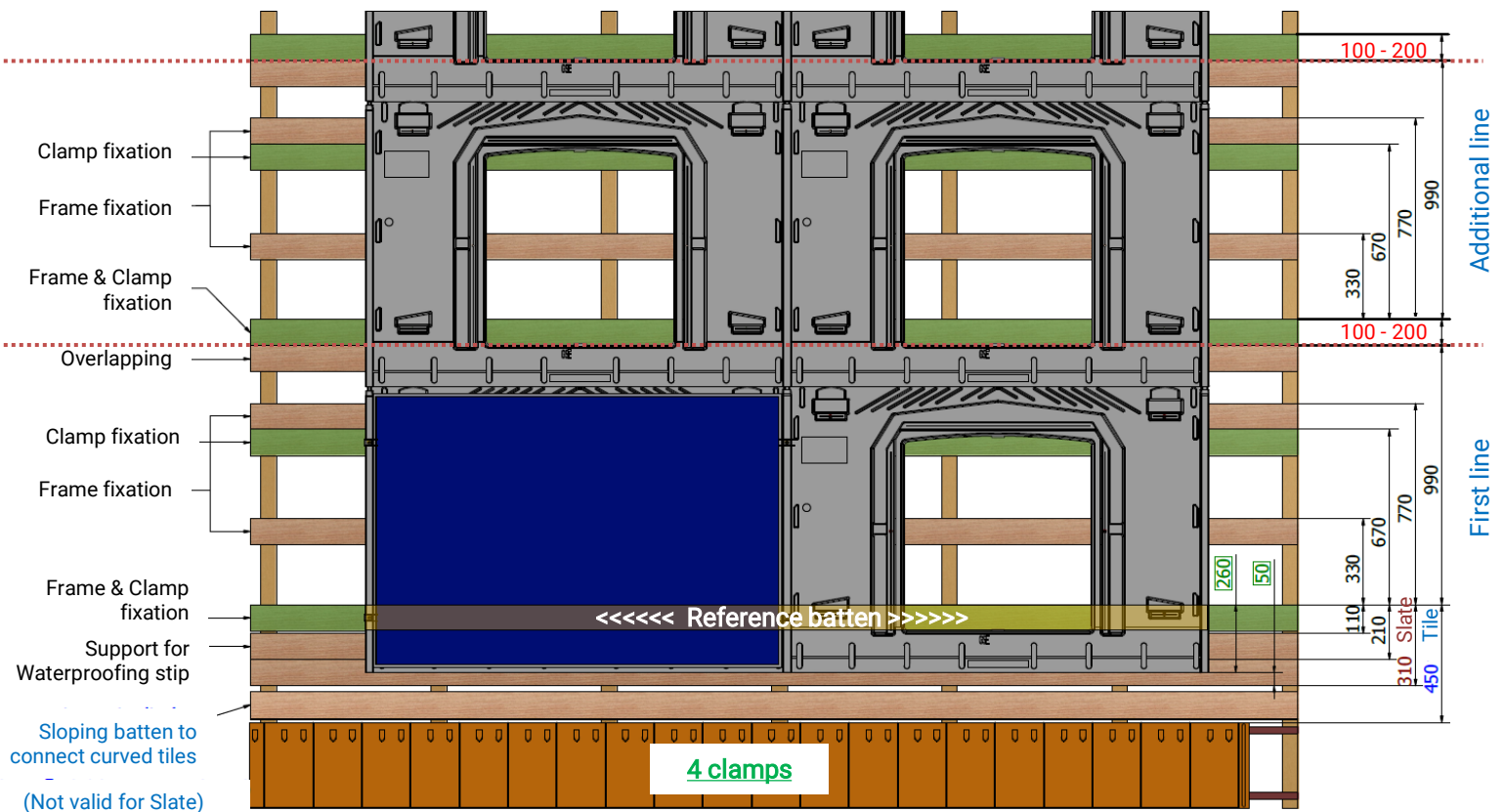

➤ **Batten width**¹ = 100mm

N.B.: the red dimension has to be adjusted according to the panel length (mm)

Panel length	First line	Additional line	Adjustment
≤1082	450 (or 310) + 990	100 + 990	0
1090	450 (or 310) + 990	110 + 990	10
1100	450 (or 310) + 990	120 + 990	20
1110	450 (or 310) + 990	130 + 990	30
1120	450 (or 310) + 990	140 + 990	40
1130	450 (or 310) + 990	150 + 990	50
1140	450 (or 310) + 990	160 + 990	60
1150	450 (or 310) + 990	170 + 990	70
1160	450 (or 310) + 990	180 + 990	80
1170	450 (or 310) + 990	190 + 990	90
1170	450 (or 310) + 990	200 + 990	100

(1) The dimension of the batten must comply with the Eurocode specifications according to the wind and snow zones of the Country. Recommendations are given in the installation manual of the GSE In-Roof System. For any questions, please, contact the technical support of GSE Integration.

Battening Plan – Landscape Frame H1082

H1082 – 6 Clamps GSE frame references: 1559/1046 - 1575/1082

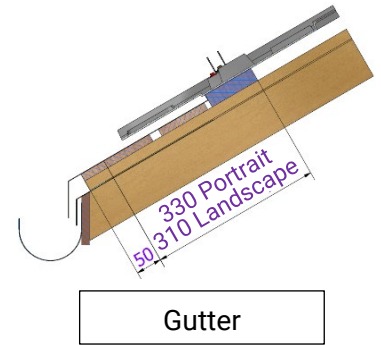
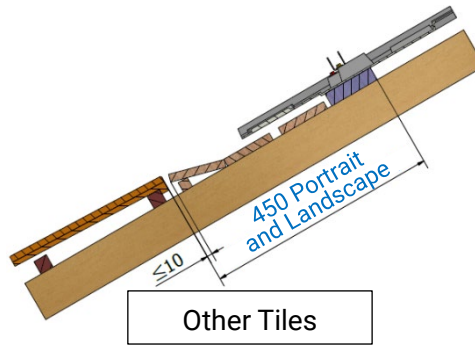
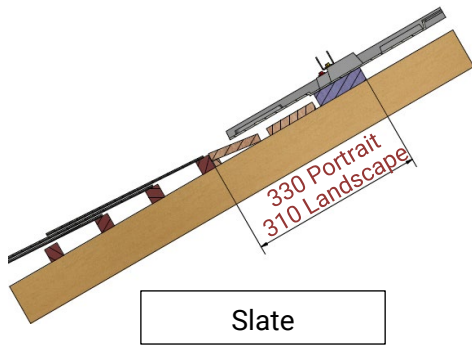
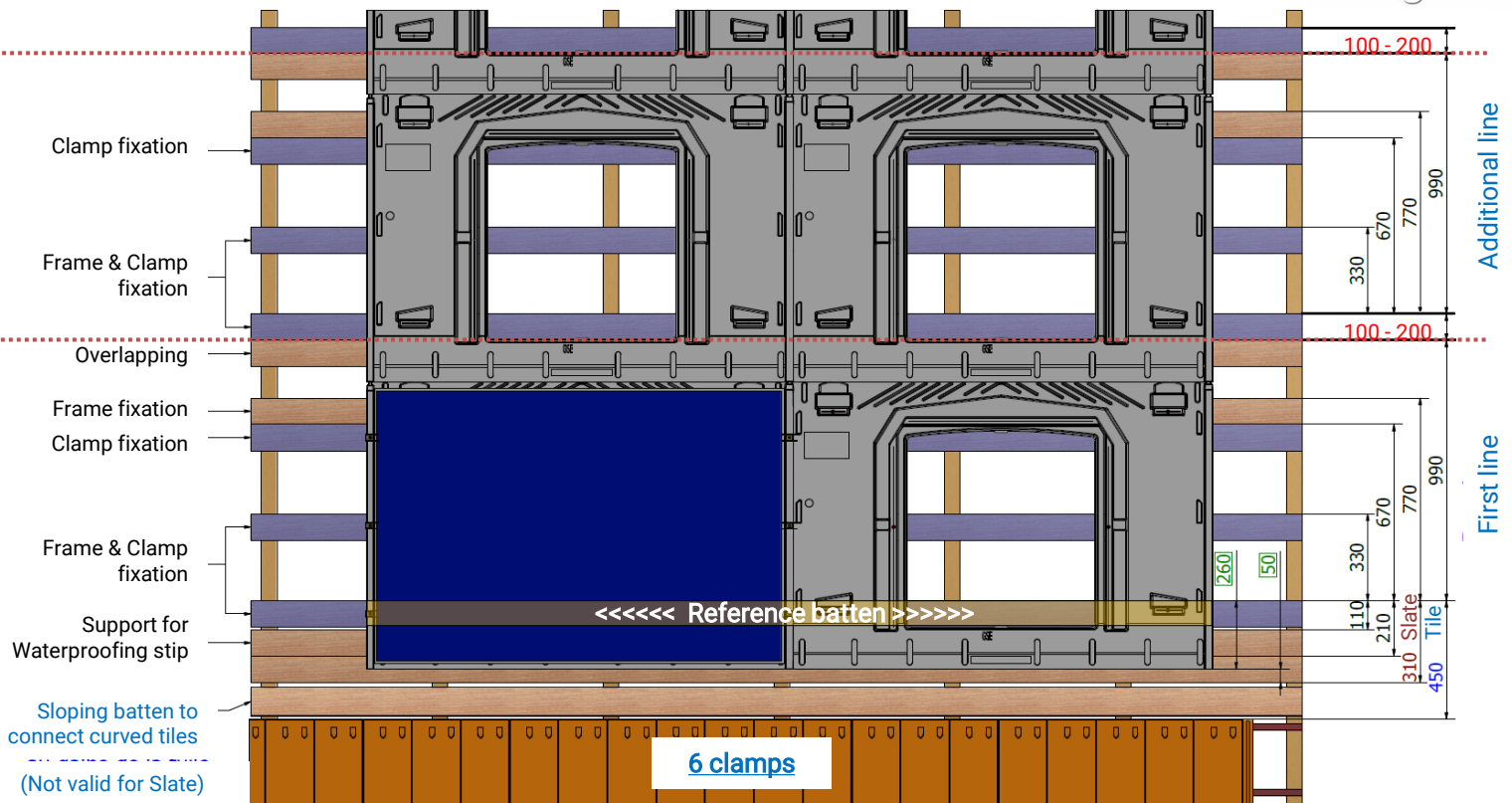

➤ **Batten width**¹ = 100mm

N.B.: the red dimension has to be adjusted according to the panel length (mm)

Panel length	First line	Additional line	Adjustment
≤1082	450 (or 310) + 990	100 + 990	0
1090	450 (or 310) + 990	110 + 990	10
1100	450 (or 310) + 990	120 + 990	20
1110	450 (or 310) + 990	130 + 990	30
1120	450 (or 310) + 990	140 + 990	40
1130	450 (or 310) + 990	150 + 990	50
1140	450 (or 310) + 990	160 + 990	60
1150	450 (or 310) + 990	170 + 990	70
1160	450 (or 310) + 990	180 + 990	80
1170	450 (or 310) + 990	190 + 990	90
1120	450 (or 310) + 930	200 + 990	100

(1) The dimension of the batten must comply with the Eurocode specifications according to the wind and snow zones of the Country. Recommendations are given in the installation manual of the GSE In-Roof System. For any questions, please, contact the technical support of GSE Integration.



Plans de lattage des plaques
format portrait

Battening Plan – Portrait Frame H1575

H1575 – 4 Clamps GSE frame references : 1559/1046 – 1575/1053 – 1575/1082

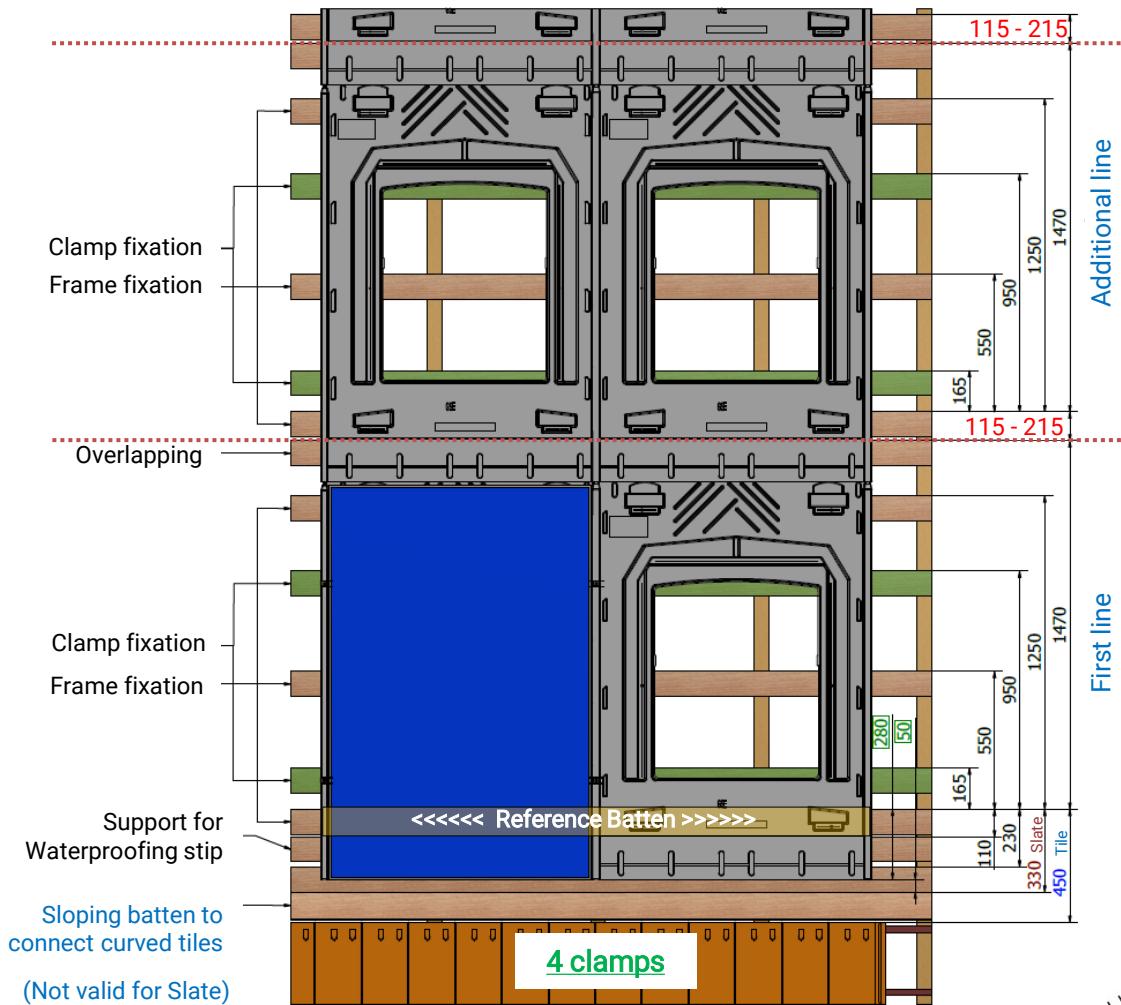

Panel length	First line	Additional line	Adjustment
≤1575	450 (or 330) + 1470	115 + 1470	0
1585	450 (or 330) + 1470	125 + 1470	10
1595	450 (or 330) + 1470	135 + 1470	20
1605	450 (or 330) + 1470	145 + 1470	30
1615	450 (or 330) + 1470	155 + 1470	40
1625	450 (or 330) + 1470	165 + 1470	50
1635	450 (or 330) + 1470	175 + 1470	60
1645	450 (or 330) + 1470	185 + 1470	70
1655	450 (or 330) + 1470	195 + 1470	80
1665	450 (or 330) + 1470	205 + 1470	90
1675	450 (or 330) + 1470	215 + 1470	100

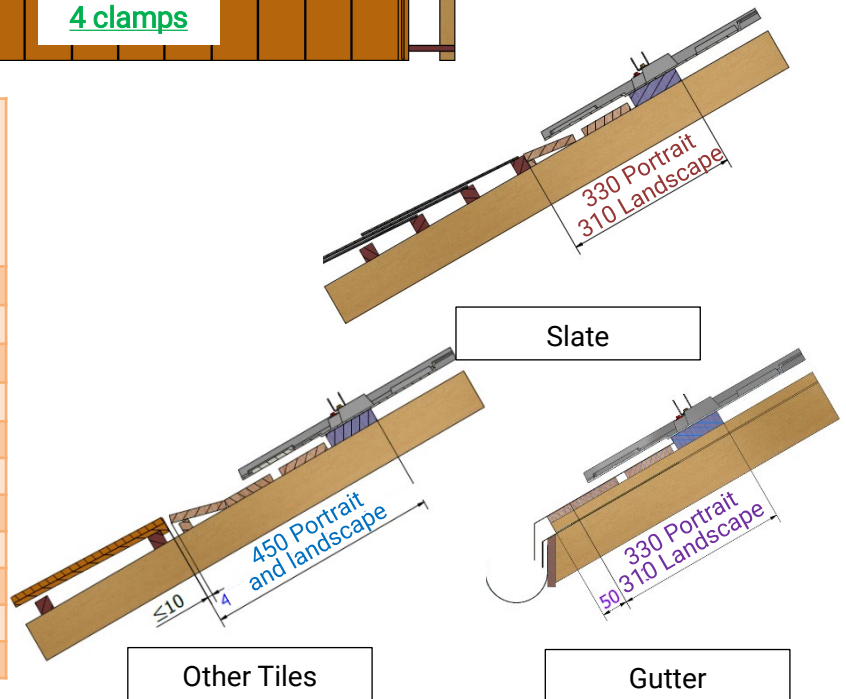

➤ **Batten width**¹ = 100mm

N.B.: the red dimension has to be adjusted according to the panel length (mm)

(1) The dimension of the batten must comply with the Eurocode specifications according to the wind and snow zones of the Country. Recommendations are given in the installation manual of the GSE In-Roof System. For any questions, please, contact the technical support of GSE Integration.

Battening Plan – Portrait Frame H1575

H1575 – 6 Clamps GSE frame references : 1559/1046 – 1575/1053 – 1575 /1082

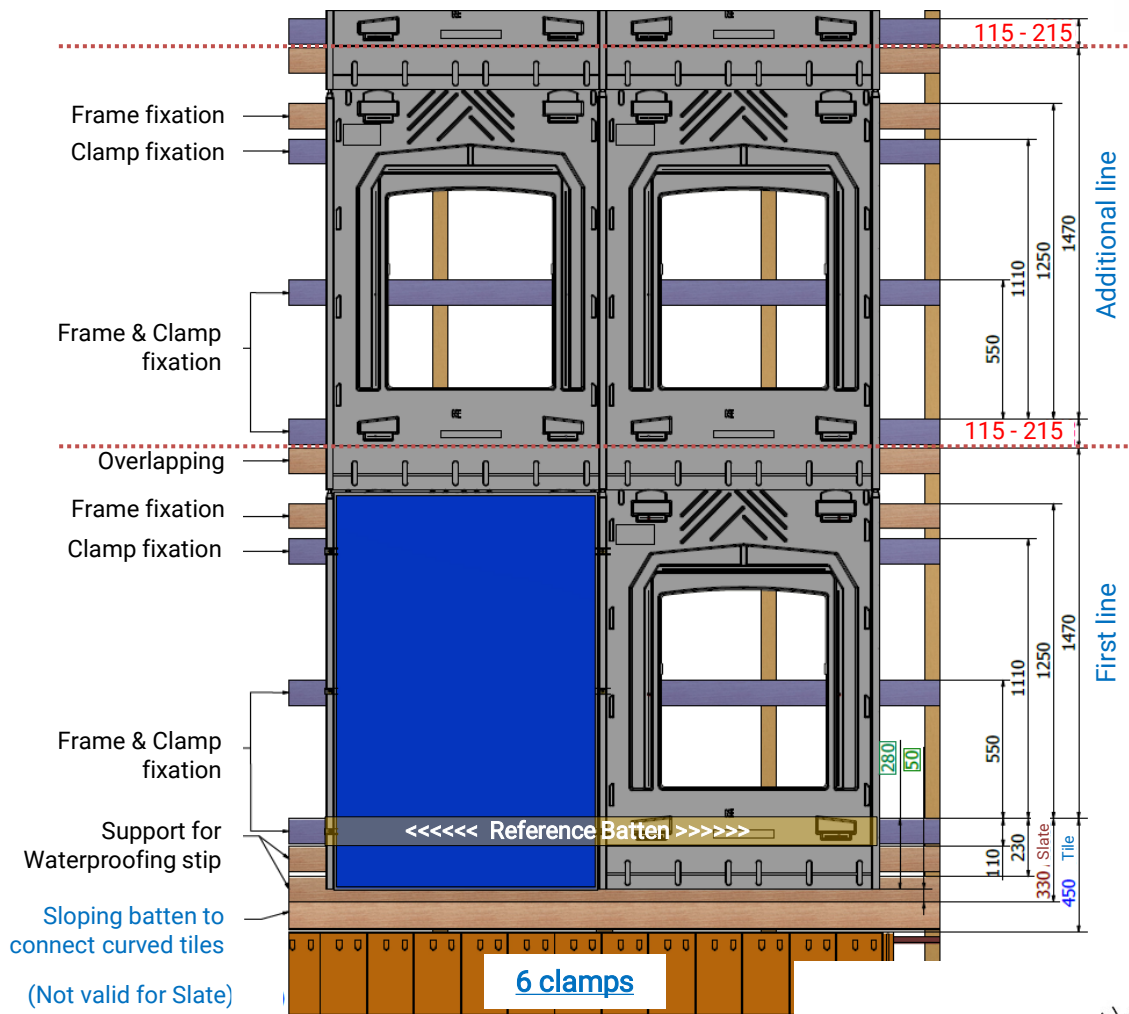

Panel length	First line	Additional line	Adjustment
≤1575	450 (or 330) + 1470	115 + 1470	0
1585	450 (or 330) + 1470	125 + 1470	10
1595	450 (or 330) + 1470	135 + 1470	20
1605	450 (or 330) + 1470	145 + 1470	30
1615	450 (or 330) + 1470	155 + 1470	40
1625	450 (or 330) + 1470	165 + 1470	50
1635	450 (or 330) + 1470	175 + 1470	60
1645	450 (or 330) + 1470	185 + 1470	70
1655	450 (or 330) + 1470	195 + 1470	80
1665	450 (or 330) + 1470	205 + 1470	90
1675	450 (or 330) + 1470	215 + 1470	100

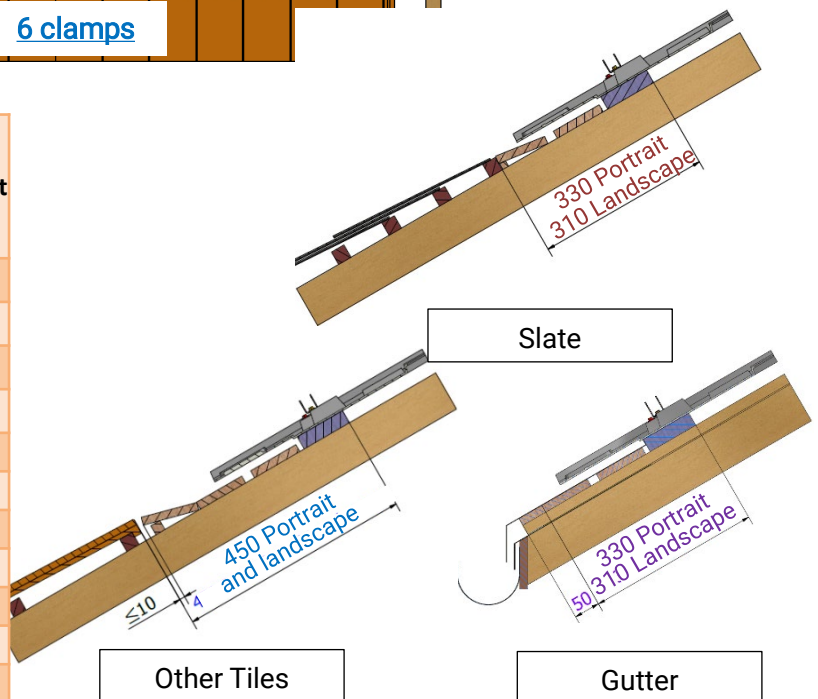

➤ **Batten width**¹ = 100mm

N.B.: the red dimension has to be adjusted according to the panel length (mm)

(1) The dimension of the batten must comply with the Eurocode specifications according to the wind and snow zones of the Country. Recommendations are given in the installation manual of the GSE In-Roof System. For any questions, please, contact the technical support of GSE Integration.

Battening Plan – Portrait Frame H1580

H1580 – 4 Clamps GSE frame references: 1580/808

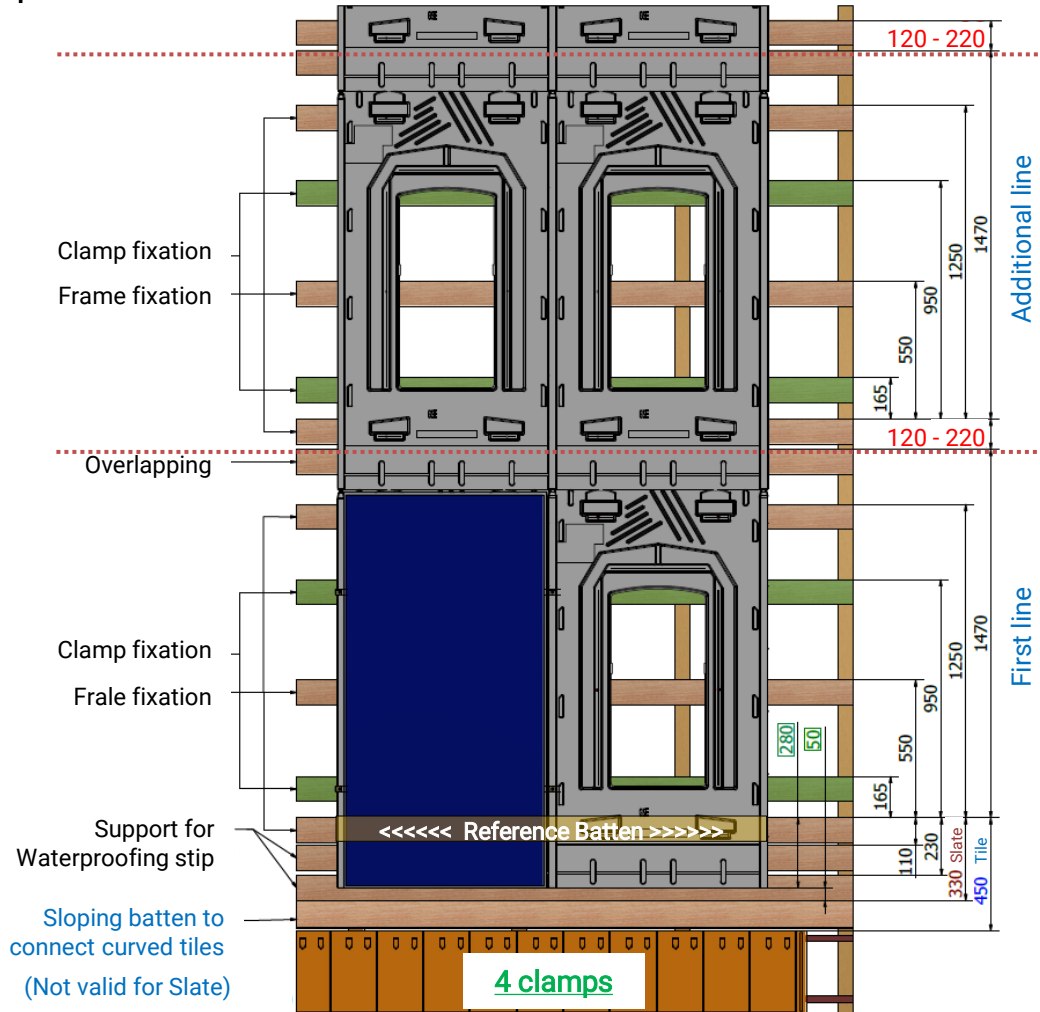

Panel length	First line	Additional line	Adjustment
≤1580	450 (or 330) + 1470	120 + 1470	0
1590	450 (or 330) + 1470	130 + 1470	10
1600	450 (or 330) + 1470	140 + 1470	20
1610	450 (or 330) + 1470	150 + 1470	30
1620	450 (or 330) + 1470	160 + 1470	40
1630	450 (or 330) + 1470	170 + 1470	50
1640	450 (or 330) + 1470	180 + 1470	60
1650	450 (or 330) + 1470	190 + 1470	70
1660	450 (or 330) + 1470	200 + 1470	80
1670	450 (or 330) + 1470	210 + 1470	90
1680	450 (or 330) + 1470	220 + 1470	100

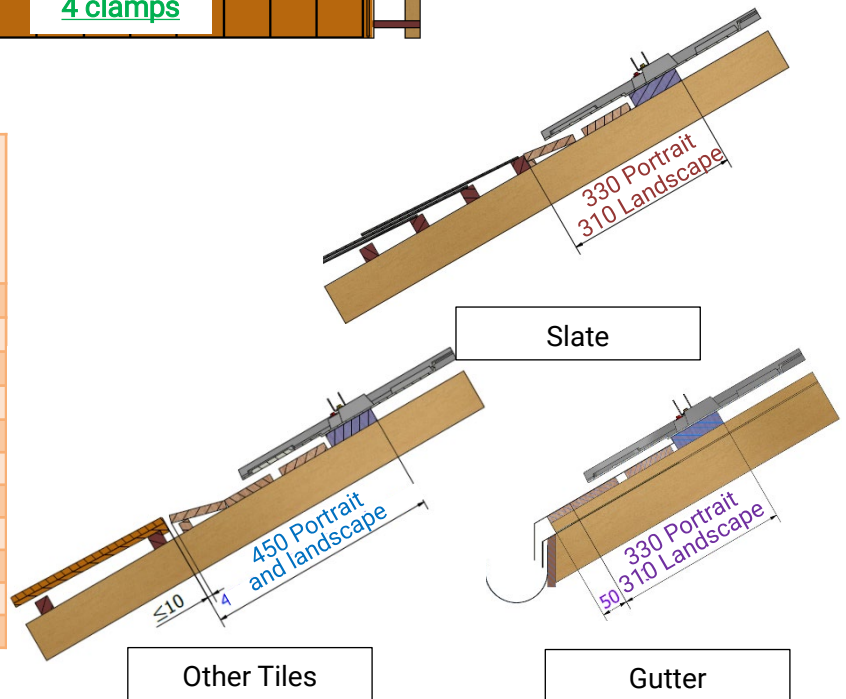

➤ **Batten width**¹ = 100mm

N.B.: the red dimension has to be adjusted according to the panel length (mm)

(1) The dimension of the batten must comply with the Eurocode specifications according to the wind and snow zones of the Country. Recommendations are given in the installation manual of the GSE In-Roof System. For any questions, please, contact the technical support of GSE Integration.

Plan de lattage – Plaque portrait H1580

H1580 – 6 Clamps GSE frame references: 1580/808

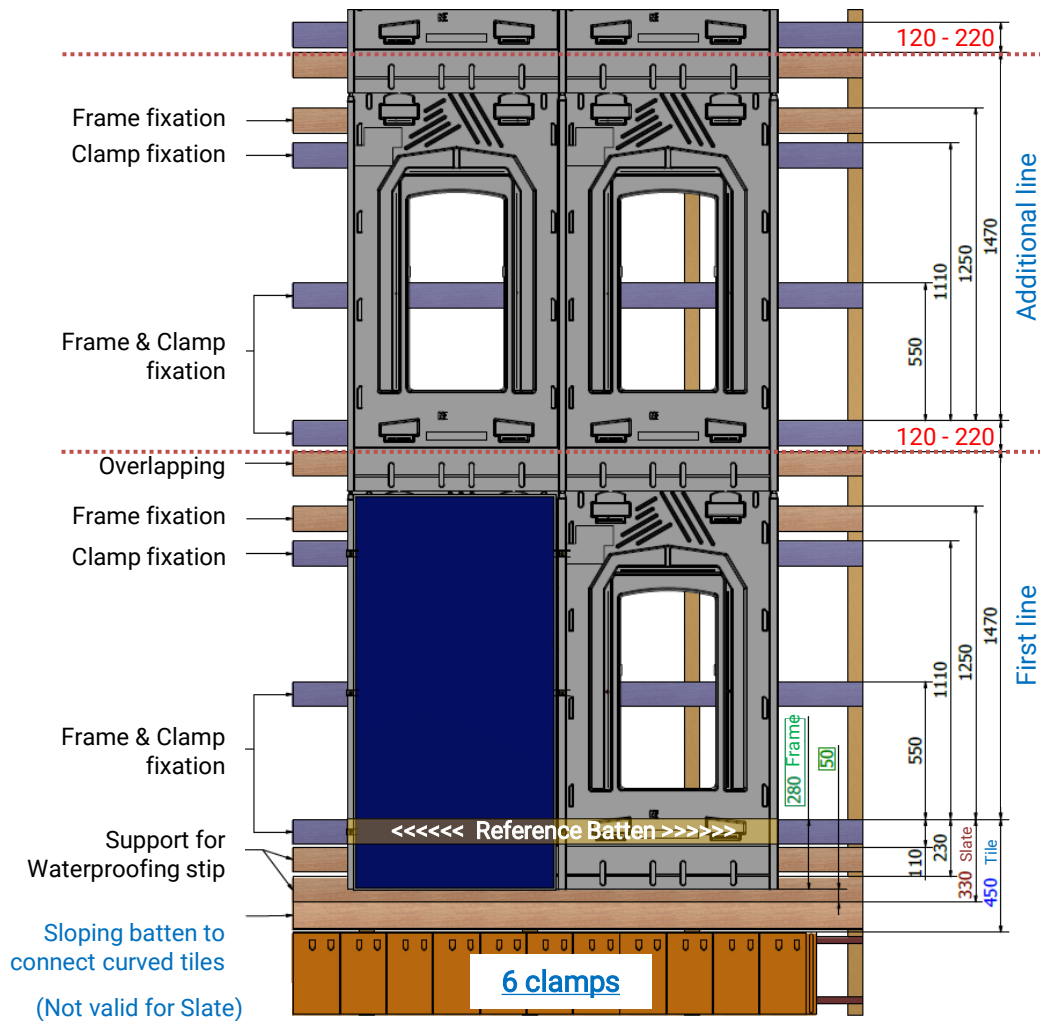

Panel length	First line	Additional line	Adjustment
≤1580	450 (or 330) + 1470	120 + 1470	0
1590	450 (or 330) + 1470	130 + 1470	10
1600	450 (or 330) + 1470	140 + 1470	20
1610	450 (or 330) + 1470	150 + 1470	30
1620	450 (or 330) + 1470	160 + 1470	40
1630	450 (or 330) + 1470	170 + 1470	50
1640	450 (or 330) + 1470	180 + 1470	60
1650	450 (or 330) + 1470	190 + 1470	70
1660	450 (or 330) + 1470	200 + 1470	80
1670	450 (or 330) + 1470	210 + 1470	90
1680	450 (or 330) + 1470	220 + 1470	100

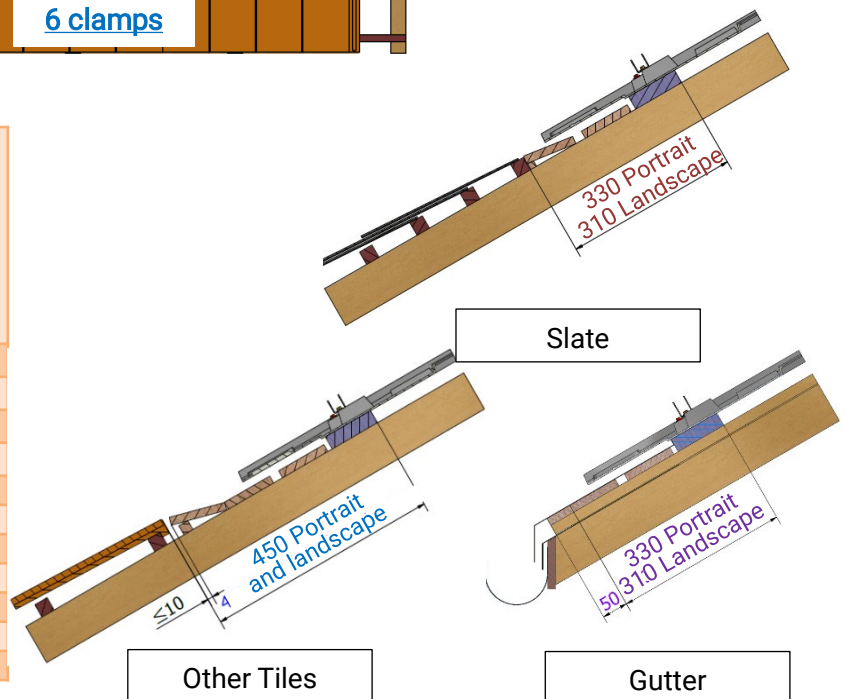

➤ **Batten width**¹ = 100mm

N.B.: the red dimension has to be adjusted according to the panel length (mm)

(1) The dimension of the batten must comply with the Eurocode specifications according to the wind and snow zones of the Country. Recommendations are given in the installation manual of the GSE In-Roof System. For any questions, please, contact the technical support of GSE Intégration.

Battening Plan – Portrait Frame H1640

H1640 – 4 Clamps GSE frame references: 1640/992 – 1640/1001

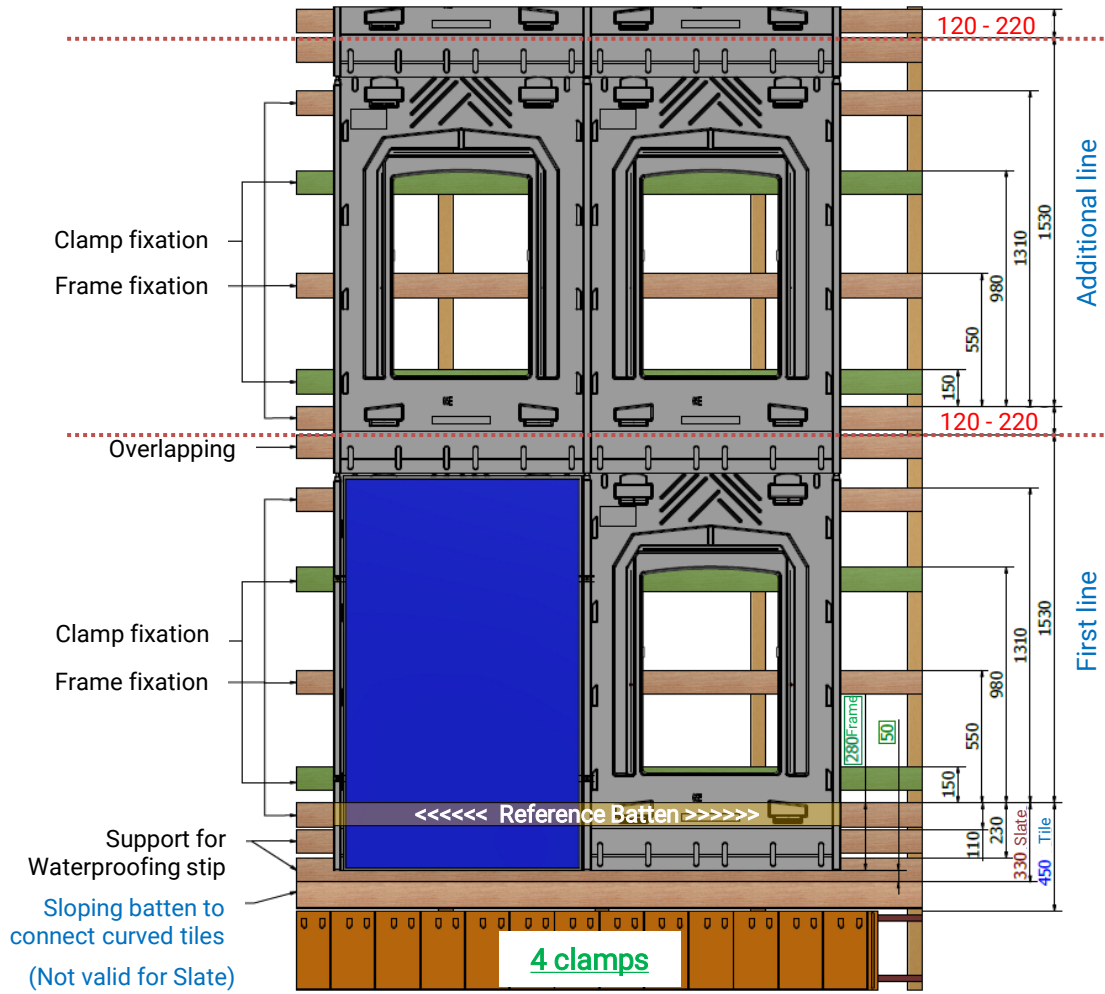

Panel length	First line	Additional line	Adjustment
≤1640	450 (or 330) + 1530	120 + 1530	0
1650	450 (or 330) + 1530	130 + 1530	10
1660	450 (or 330) + 1530	140 + 1530	20
1670	450 (or 330) + 1530	150 + 1530	30
1680	450 (or 330) + 1530	160 + 1530	40
1690	450 (or 330) + 1530	170 + 1530	50
1700	450 (or 330) + 1530	180 + 1530	60
1710	450 (or 330) + 1530	190 + 1530	70
1720	450 (or 330) + 1530	200 + 1530	80
1730	450 (or 330) + 1530	210 + 1530	90
1740	450 (or 330) + 1530	220 + 1530	100

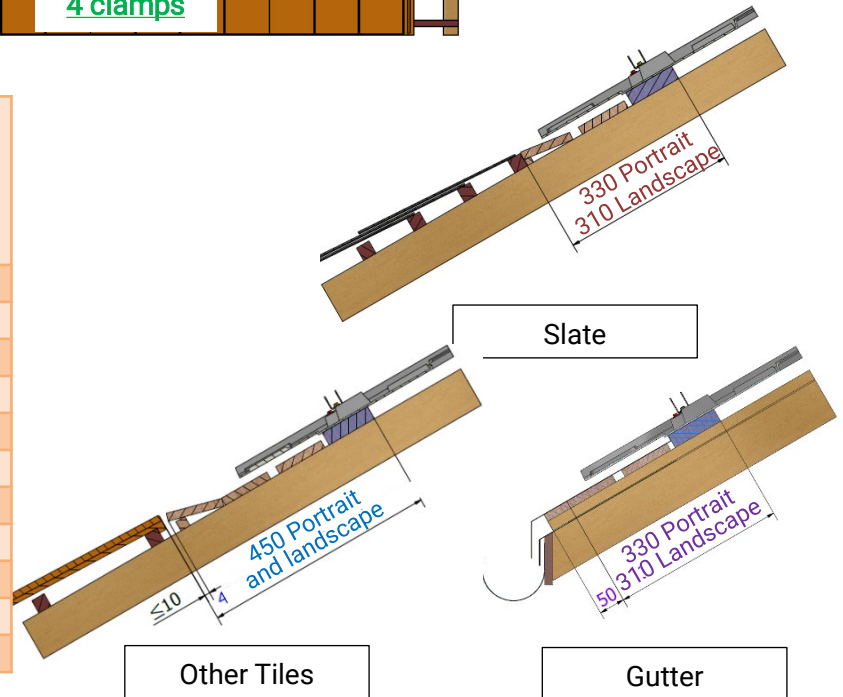

➤ **Batten width**¹ = 100mm

N.B.: the red dimension has to be adjusted according to the panel length (mm)

(1) The dimension of the batten must comply with the Eurocode specifications according to the wind and snow zones of the Country. Recommendations are given in the installation manual of the GSE In-Roof System. For any questions, please, contact the technical support of GSE Integration.

Battening Plan – Portrait Frame H1640

H1640 – 6 Clamps GSE frame references : 1640/992 – 1640/1001

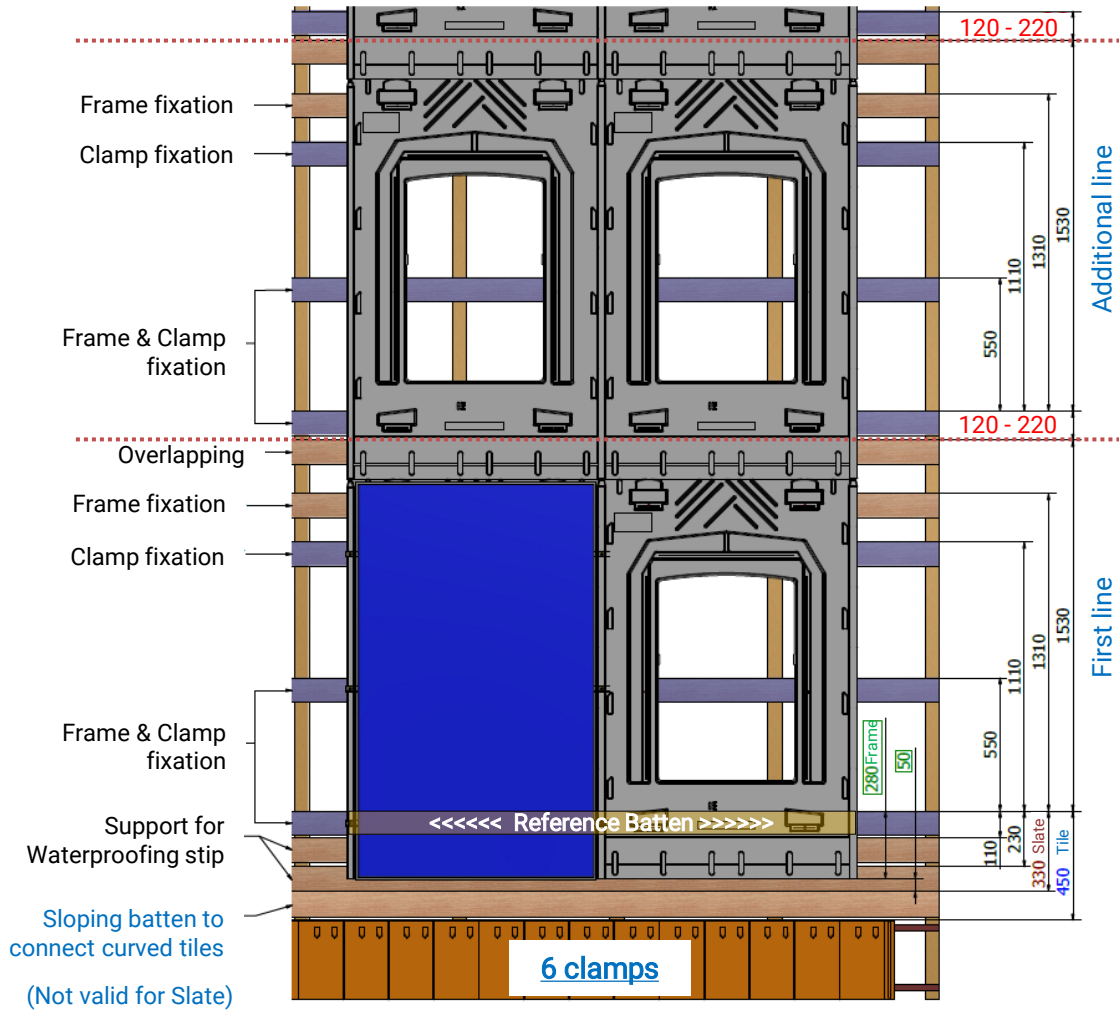

Panel length	First line	Additional line	Adjustment
≤1640	450 (or 330) + 1530	120 + 1530	0
1650	450 (or 330) + 1530	130 + 1530	10
1660	450 (or 330) + 1530	140 + 1530	20
1670	450 (or 330) + 1530	150 + 1530	30
1680	450 (or 330) + 1530	160 + 1530	40
1690	450 (or 330) + 1530	170 + 1530	50
1700	450 (or 330) + 1530	180 + 1530	60
1710	450 (or 330) + 1530	190 + 1530	70
1720	450 (or 330) + 1530	200 + 1530	80
1730	450 (or 330) + 1530	210 + 1530	90
1740	450 (or 330) + 1530	220 + 1530	100

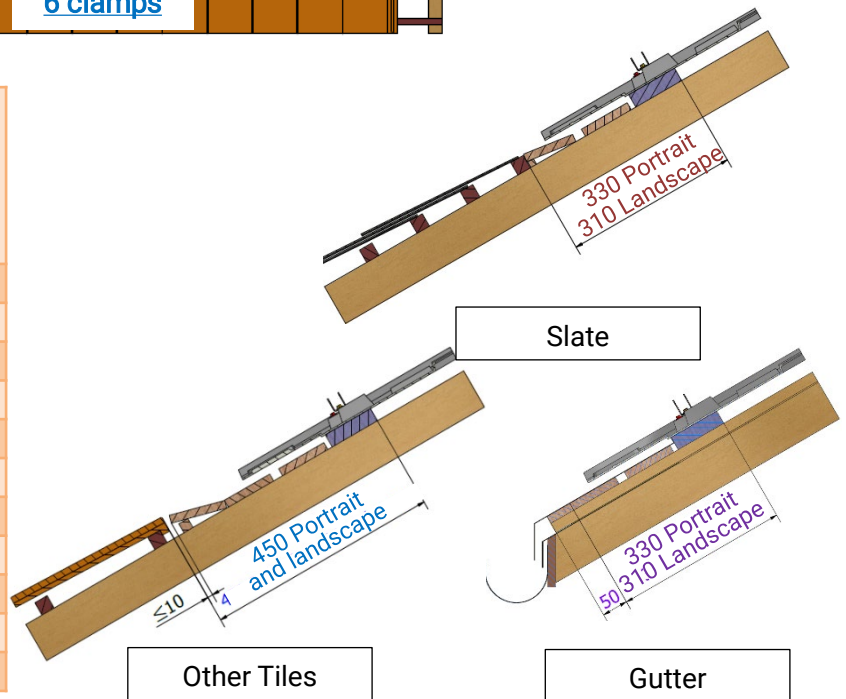

➤ **Batten width¹ = 100mm**

N.B.: the red dimension has to be adjusted according to the panel length (mm)

(1) The dimension of the batten must comply with the Eurocode specifications according to the wind and snow zones of the Country. Recommendations are given in the installation manual of the GSE In-Roof System. For any questions, please, contact the technical support of GSE Integration.

Battening Plan – Portrait Frame H1686

H1686 – 4 Clamps GSE frame references: 1686/1016

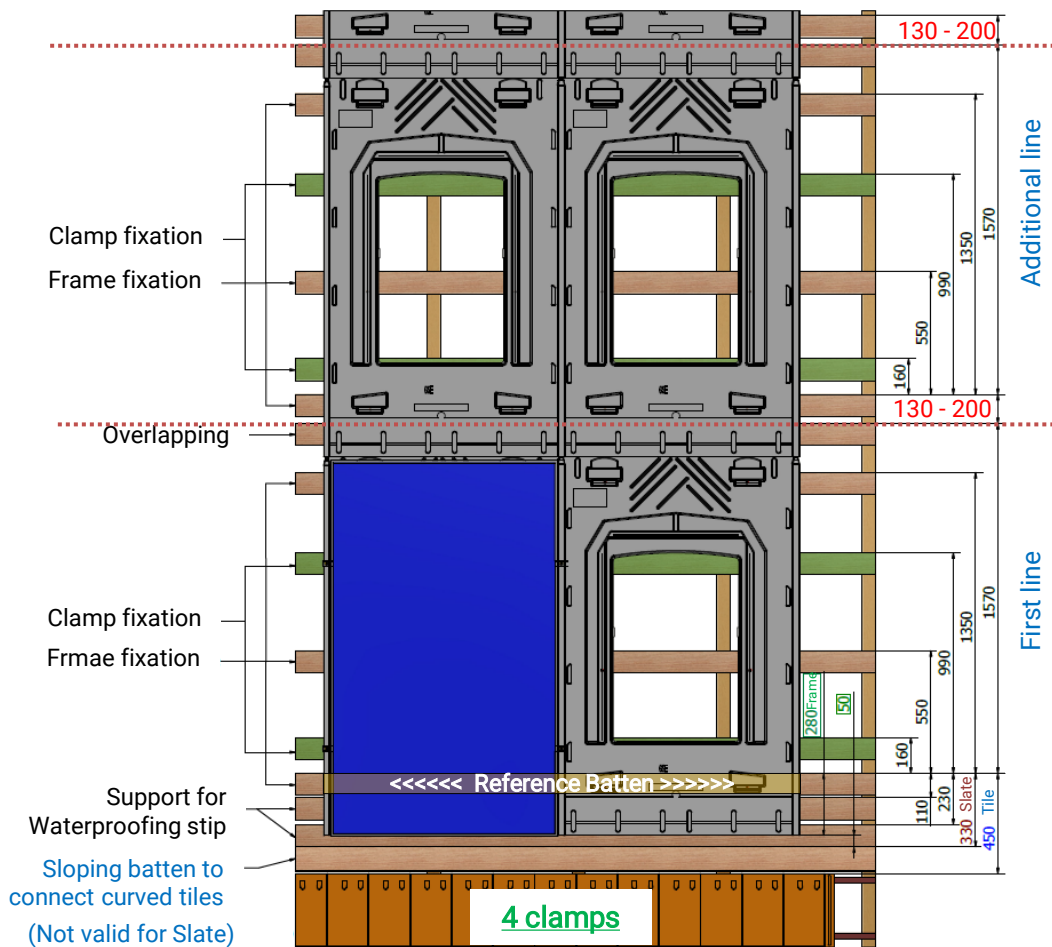

Panel length	First line	Additional line	Adjustment
≤1686	450 (or 330) + 1570	130 + 1570	0
1696	450 (or 330) + 1570	140 + 1570	10
1706	450 (or 330) + 1570	150 + 1570	20
1716	450 (or 330) + 1570	160 + 1570	30
1726	450 (or 330) + 1570	170 + 1570	40
1736	450 (or 330) + 1570	180 + 1570	50
1746	450 (or 330) + 1570	190 + 1570	60
1756	450 (or 330) + 1570	200 + 1570	70

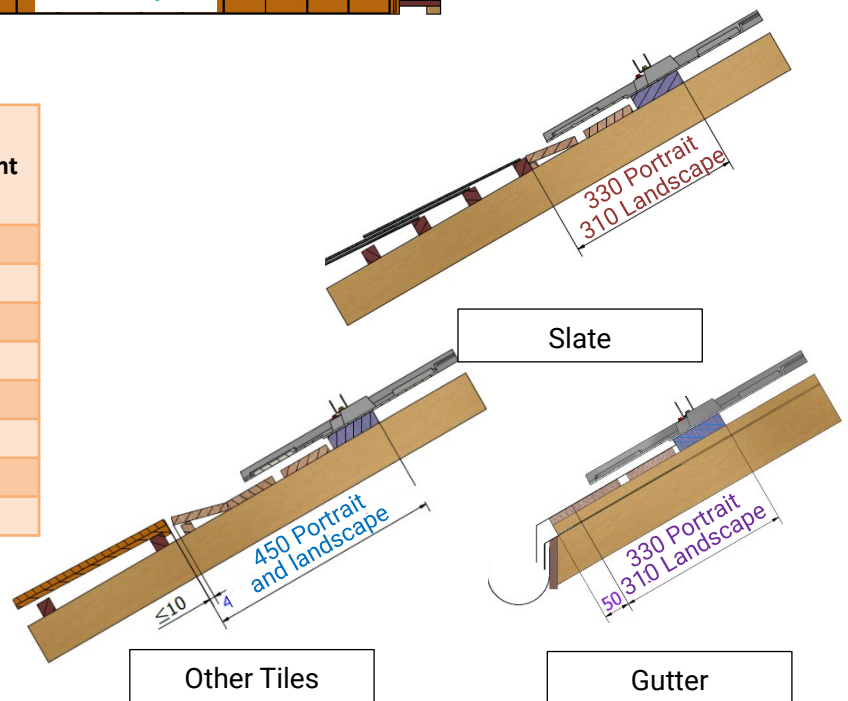

➤ **Batten width**¹ = 100mm

N.B.: the red dimension has to be adjusted according to the panel length (mm)

(1) The dimension of the batten must comply with the Eurocode specifications according to the wind and snow zones of the Country. Recommendations are given in the installation manual of the GSE In-Roof System. For any questions, please, contact the technical support of GSE Integration.

Battening Plan – Portrait Frame H1686

H1686 – 6 Clamps GSE frame references: 1686/1016

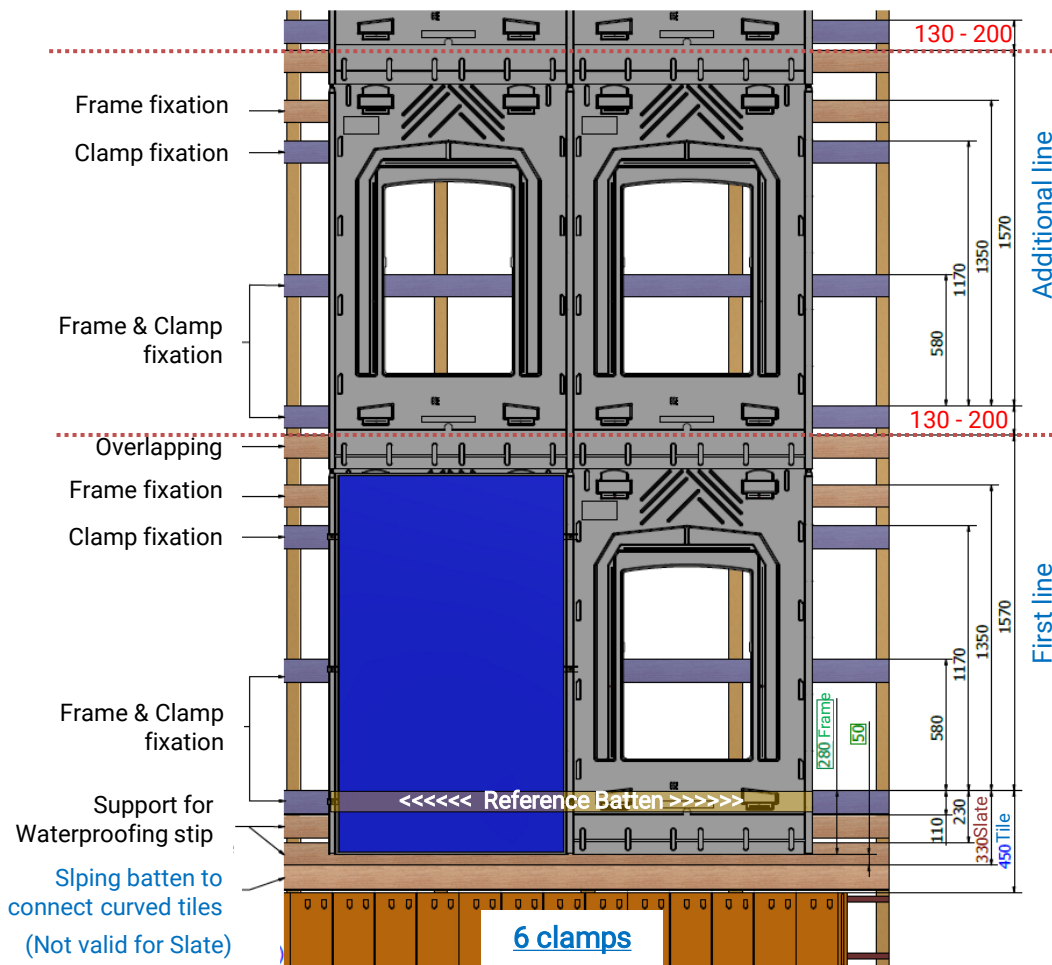

Panel length	First line	Additional line	Adjustment
≤1686	450 (or 330) + 1570	130 + 1570	0
1696	450 (or 330) + 1570	140 + 1570	10
1706	450 (or 330) + 1570	150 + 1570	20
1716	450 (or 330) + 1570	160 + 1570	30
1726	450 (or 330) + 1570	170 + 1570	40
1736	450 (or 330) + 1570	180 + 1570	50
1746	450 (or 330) + 1570	190 + 1570	60
1756	450 (or 330) + 1570	200 + 1570	70

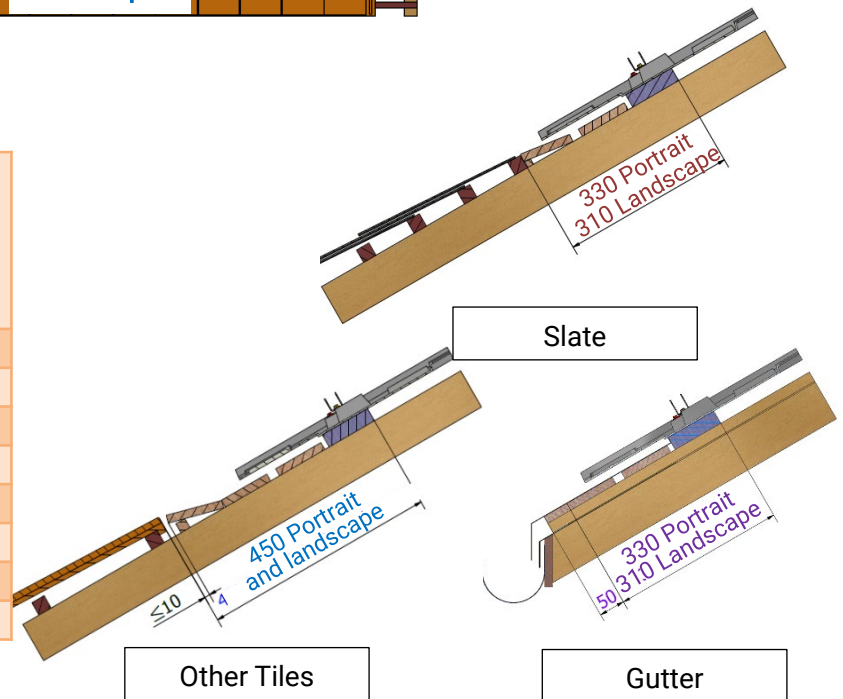

➤ **Batten width**¹ = 100mm

N.B.: the red dimension has to be adjusted according to the panel length (mm)

(1) The dimension of the batten must comply with the Eurocode specifications according to the wind and snow zones of the Country. Recommendations are given in the installation manual of the GSE In-Roof System. For any questions, please, contact the technical support of GSE Intégration.

Battening Plan – Portrait Frame H1710

H1710 – 4 Clamps GSE frame references:

1710/995 – 1710/1000 – 1710/1005 – 1710/1010 – 1710/1020 – 1710/1025 – 1710/1030 – 1710/1040 – 1710/1045 – 1710/1050 – 1710/1055

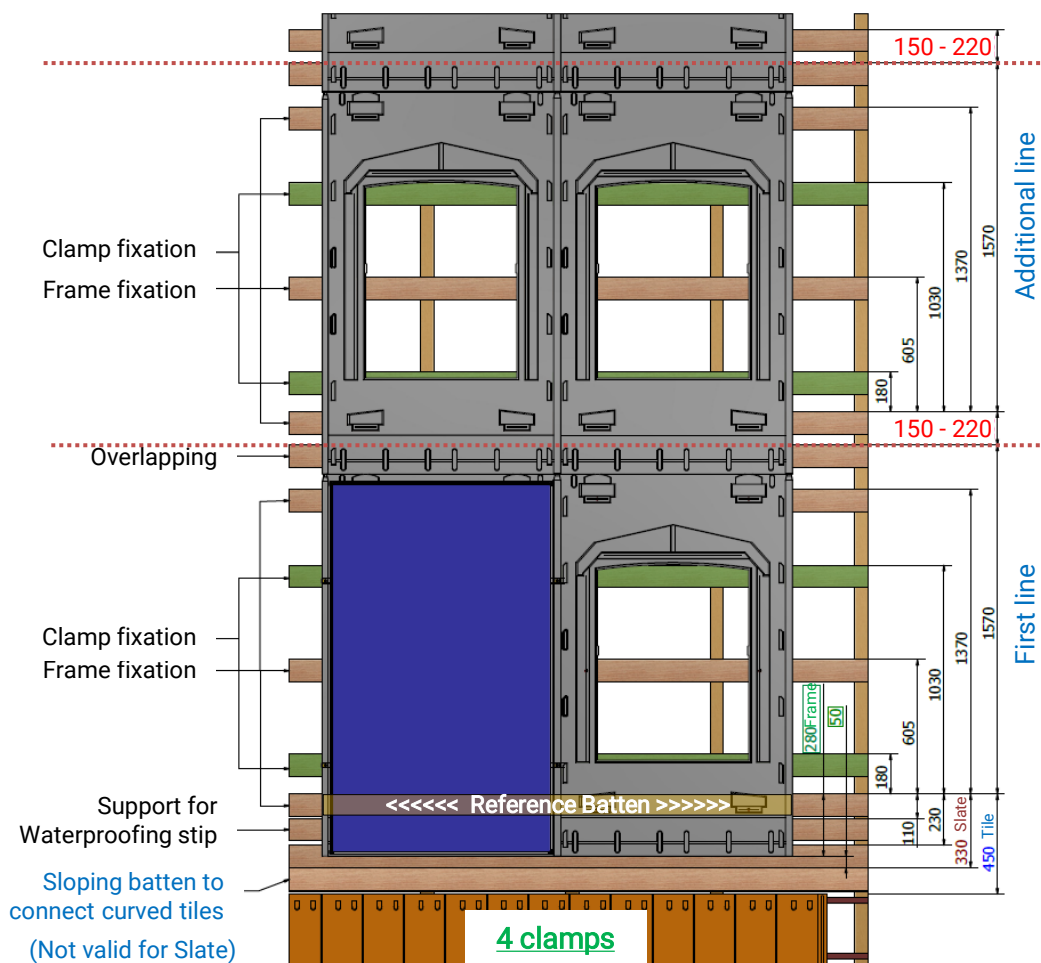

Panel length	First line	Additional line	Adjustment
≤1710	450 (or 330) + 1570	150 + 1570	0
1720	450 (or 330) + 1570	160 + 1570	10
1730	450 (or 330) + 1570	170 + 1570	20
1740	450 (or 330) + 1570	180 + 1570	30
1750	450 (or 330) + 1570	190 + 1570	40
1760	450 (or 330) + 1570	200 + 1570	50
1770	450 (or 330) + 1570	210 + 1570	60
1780	450 (or 330) + 1570	220 + 1570	70

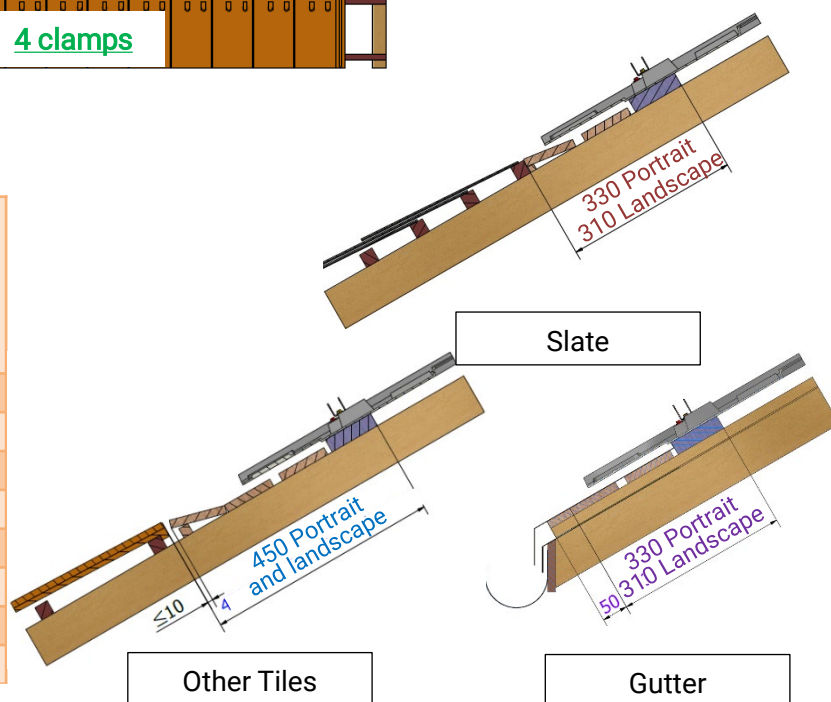

➤ **Batten width**¹ = 100mm

N.B.: the red dimension has to be adjusted according to the panel length (mm)

(1) The dimension of the batten must comply with the Eurocode specifications according to the wind and snow zones of the Country. Recommendations are given in the installation manual of the GSE In-Roof System. For any questions, please, contact the technical support of GSE Integration.

Battening Plan – Portrait Frame H1710

H1710 – 6 Clamps GSE frame references:

1710/995 – 1710/1000 – 1710/1005 – 1710/1010 – 1710/1020 – 1710/1025 – 1710/1030 – 1710/1040 – 1710/1045 – 1710/1050 – 1710/1055

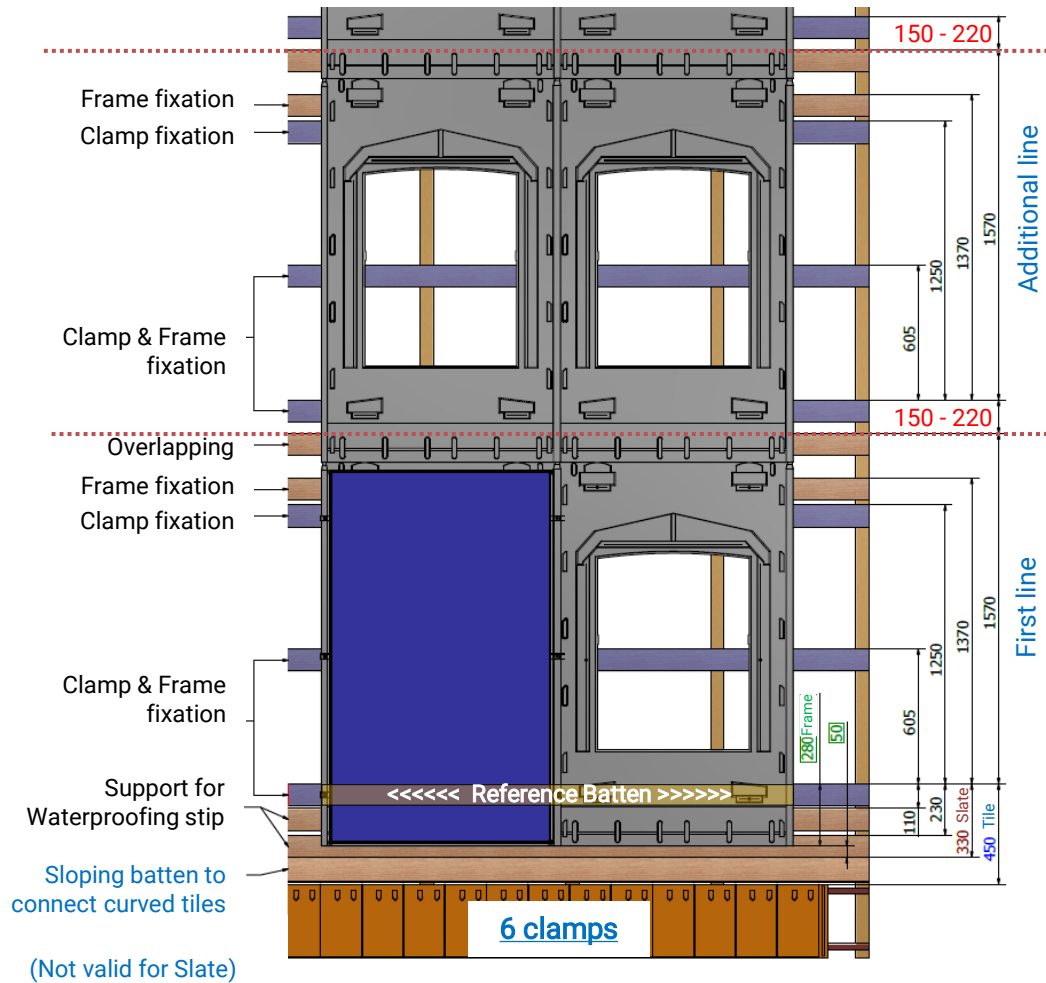

(Not valid for Slate)

Panel length	First line	Additional line	Adjustment
≤1710	450 (or 330) + 1570	150 + 1570	0
1720	450 (or 330) + 1570	160 + 1570	10
1730	450 (or 330) + 1570	170 + 1570	20
1740	450 (or 330) + 1570	180 + 1570	30
1750	450 (or 330) + 1570	190 + 1570	40
1760	450 (or 330) + 1570	200 + 1570	50
1770	450 (or 330) + 1570	210 + 1570	60
1780	450 (or 330) + 1570	220 + 1570	70

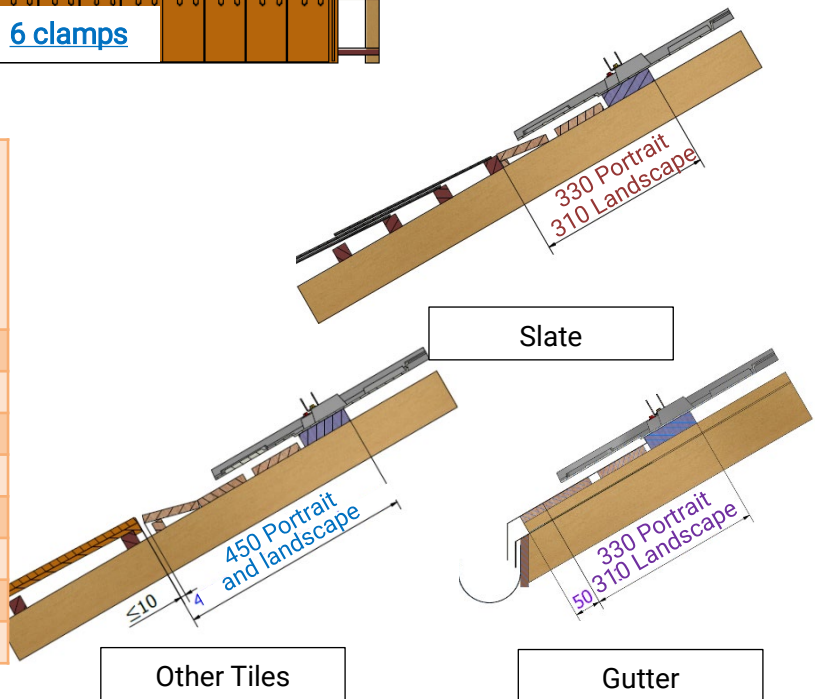

➤ **Batten width**¹ = 100mm

N.B.: the red dimension has to be adjusted according to the panel length (mm)

(1) The dimension of the batten must comply with the Eurocode specifications according to the wind and snow zones of the Country. Recommendations are given in the installation manual of the GSE In-Roof System. For any questions, please, contact the technical support of GSE Integration.

Battening Plan – Portrait Half-Frame H1650

H1650 – 4 Clamps GSE half-frame references: 1650/995 – 1650/1070 – 1650/1100 – 1650/1135 – 1650/1140 – 1650/1145 – 1650/1160

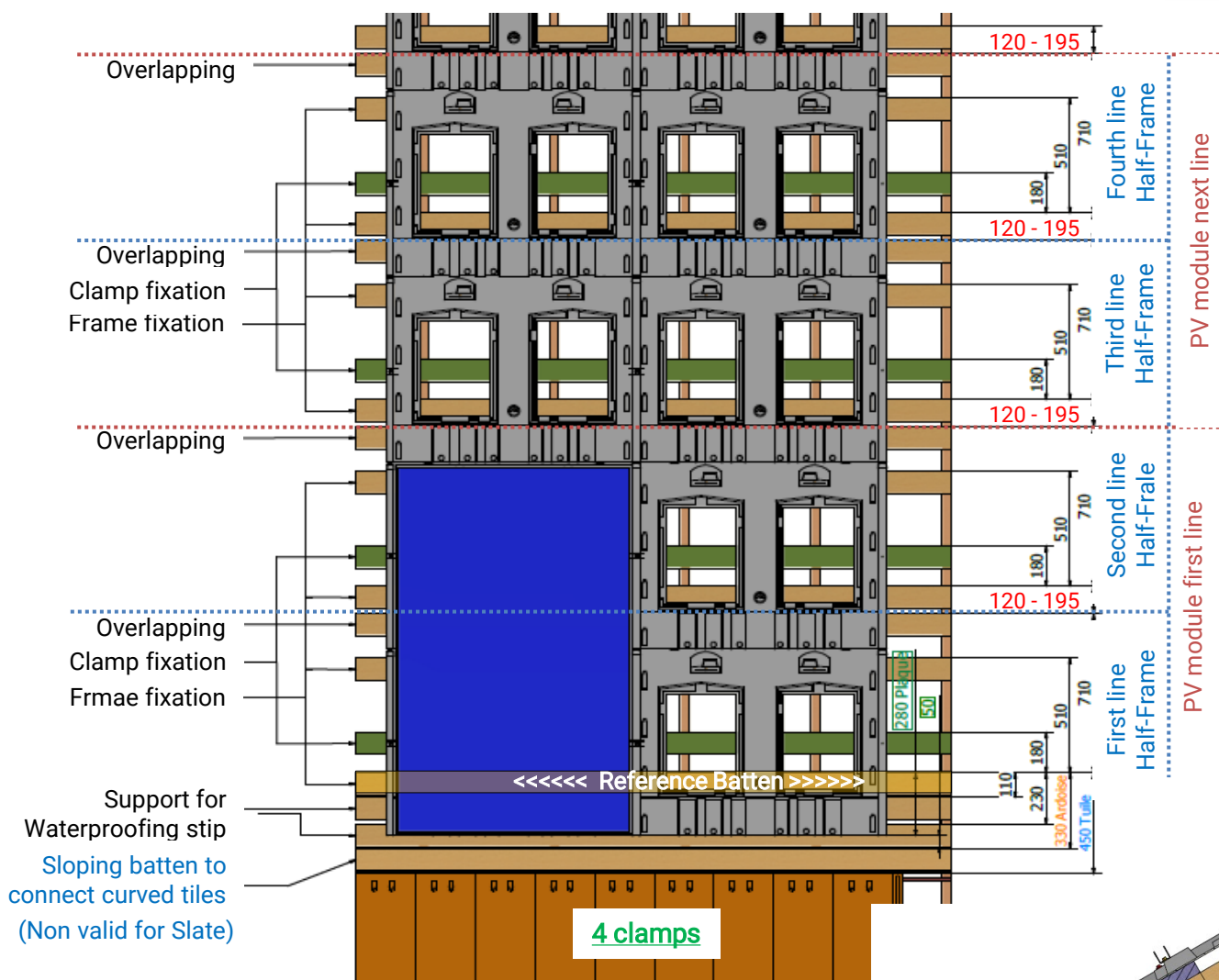

Panel length	First line	Additional line	Adjustment
≤1650	450 (ou 330) + 710	120 + 710	0
1660	450 (ou 330) + 710	125 + 710	5
1670	450 (ou 330) + 710	130 + 710	10
1680	450 (ou 330) + 710	135 + 710	15
1690	450 (ou 330) + 710	140 + 710	20
1700	450 (ou 330) + 710	145 + 710	25
1710	450 (ou 330) + 710	150 + 710	30
1720	450 (ou 330) + 710	155 + 710	35
1730	450 (ou 330) + 710	160 + 710	40
1740	450 (ou 330) + 710	165 + 710	45
1750	450 (ou 330) + 710	170 + 710	50
1760	450 (ou 330) + 710	175 + 710	55
1770	450 (ou 330) + 710	180 + 710	60
1780	450 (ou 330) + 710	185 + 710	65
1790	450 (ou 330) + 710	190 + 710	70
1800	450 (ou 330) + 710	195 + 710	75

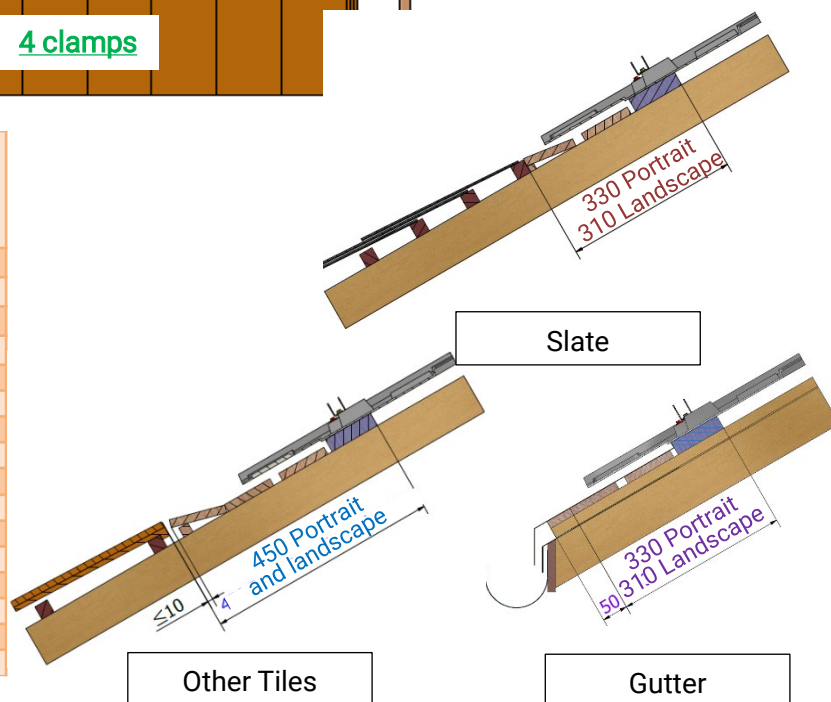

➤ **Batten width**¹ = 100mm

N.B.: the red dimension has to be adjusted according to the panel length (mm)

(1) The dimension of the batten must comply with the Eurocode specifications according to the wind and snow zones of the Country. Recommendations are given in the installation manual of the GSE In-Roof System. For any questions, please, contact the technical support of GSE Integration.

Plan de lattage – Demi-Plaque Portrait H1840

H1840 – 4 Clamps GSE half-frame references: 1840/995 – 1840/1020 – 1840/1030 – 1840/1040 - 1840/1045 – 1840/1050 – 1840/1070 - 1840/1090 - 1840/1100 – 1840/1135

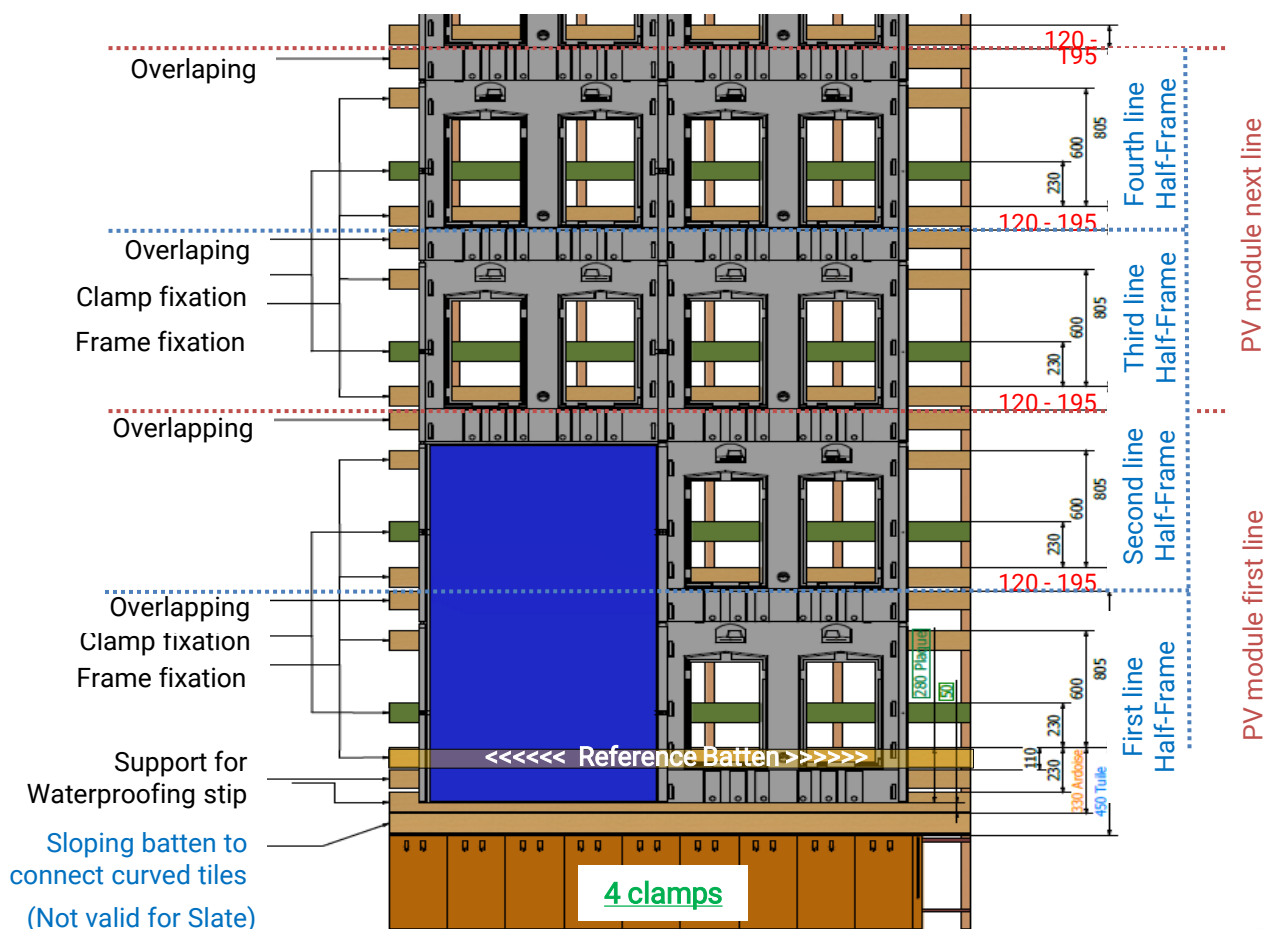

Panel length	First line	Additional line	Adjustment
≤1650	450 (ou 330) + 805	120 + 805	0
1660	450 (ou 330) + 805	125 + 805	5
1670	450 (ou 330) + 805	130 + 805	10
1680	450 (ou 330) + 805	135 + 805	15
1690	450 (ou 330) + 805	140 + 805	20
1700	450 (ou 330) + 805	145 + 805	25
1710	450 (ou 330) + 805	150 + 805	30
1720	450 (ou 330) + 805	155 + 805	35
1730	450 (ou 330) + 805	160 + 805	40
1740	450 (ou 330) + 805	165 + 805	45
1750	450 (ou 330) + 805	170 + 805	50
1760	450 (ou 330) + 805	175 + 805	55
1770	450 (ou 330) + 805	180 + 805	60
1780	450 (ou 330) + 805	185 + 805	65
1790	450 (ou 330) + 805	190 + 805	70
1800	450 (ou 330) + 805	195 + 805	75

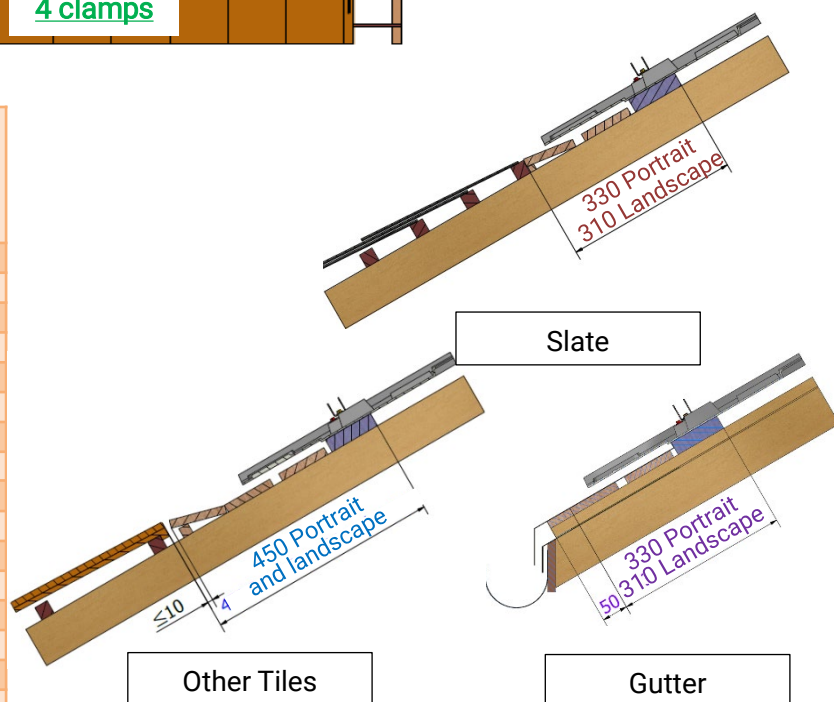

➤ **Batten width**¹ = 100mm

N.B.: the red dimension has to be adjusted according to the panel length (mm)

(1) The dimension of the batten must comply with the Eurocode specifications according to the wind and snow zones of the Country. Recommendations are given in the installation manual of the GSE In-Roof System. For any questions, please, contact the technical support of GSE Integration.

GSE
Intégration

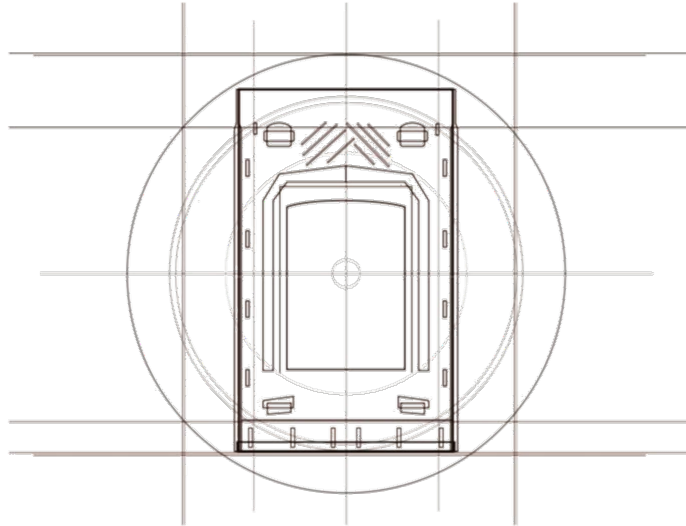

GSE IN-ROOF SYSTEM™
is a patented development project of GSE INTÉGRATION

GSE
Intégration

Your distributor:

www.gseintegration.com