



LITHIUM IRON PHOSPHATE

# BATTERY INSTALLATION MANUAL

GENERATION 3 | Giv-Bat 5.12

GIV-BAT-5.12-G3



**SMALLER. LIGHTER. MORE POWERFUL.**  
Our third-generation battery is here

The third generation of the GivEnergy 5.12kWh battery is more efficient than ever before. As well as its new smaller size and lower weight, the Giv-Bat 5.12 comes with higher capacity plus 100% depth of discharge.

The product also boasts maximum versatility. Its compact design means it can be wall mounted, floor stood, and installed in a variety of locations. It's also primed to use in a modular way – allowing the system to scale with the needs of the customer. Plus, plug and play terminations make for super easy installations.

Specifications

**Dimensions**  
338H X 242D x 480W (mm)

**Weight**  
48±2kg

**Usable capacity**  
5.12 kWh / 100 Ah

**Voltage**  
51.2V DC

**Current**  
60A continuous 120A peak

**Warranty**  
12 years

**Charging temperature**  
0°C - 55°C

**Discharging Temperature**  
-10°C - 55°C

**Depth of Discharge**  
100%

**SKU**  
GIV-BAT-5.12-G3

Item	Item Name		Qty
A	Battery Module	Battery Module	1
B	Wall Mounting Bracket	Wall Mounting Bracket	1
C	User manual	Documentation	1
D	Expansion bolts	Fixing	4
E	Ground screw	Fixing	1
F	Security screw	Fixing	2

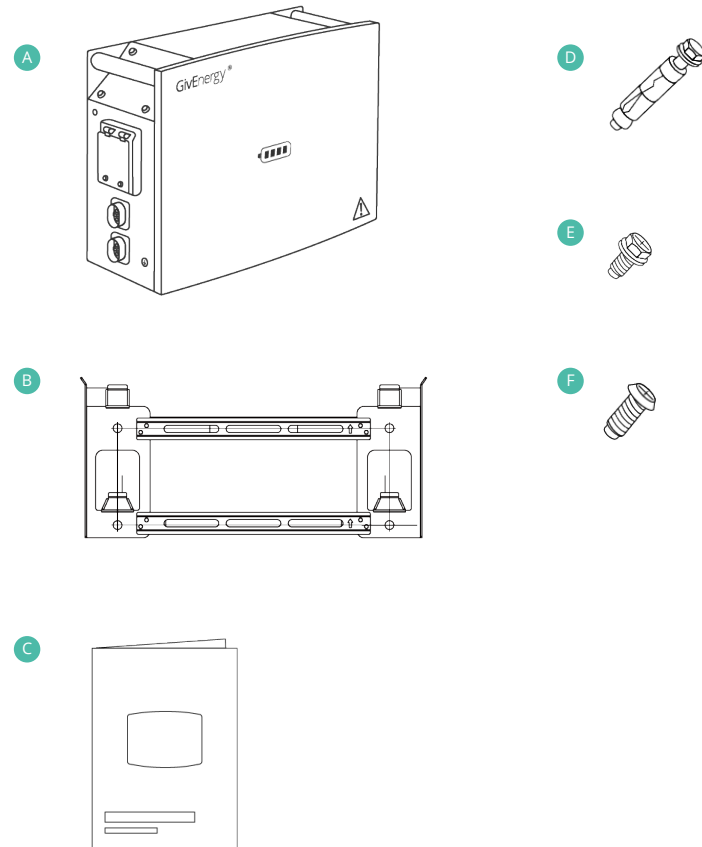

## Introduction

All information contained in this booklet refers to the assembly, installation, commissioning, and maintenance of the Generation 3 battery. Please retain this manual for future reference.

**Legal Disclaimer:** This document is the property of GivEnergy, reproduction is prohibited.

## Installation Requirements

Installation of all GivEnergy equipment must be carried out by a **GivEnergy approved installer**.

## Unit Information

The Generation 3 batteries are designed to work with a GivEnergy AC Coupled or Hybrid Inverter. The batteries work with renewable generation or import from the grid at off-peak times when prices are lower, and discharge during busier periods when prices are more expensive.

## Storing the Battery

The units must be stored in their original packaging at temperatures between -30°C - 60°C. Please note that between -10°C - 0°C there may be reduced performance in charging and discharging.

Do not stack more than 4 units on top of each other. Stock batteries need to be replenished and maintained every five months. If the battery is stored in the warehouse for more than 6 months, the battery may need to be replenished before delivery.

## Packaging Contents

When unpacking, please check the following:

- ✔ There are no missing accessories from the packaging list
- ✔ The model and specification of the battery's nameplate match the order specifications

If any damaged or missing parts are found, please contact GivEnergy on **01377 252 874** or email **support@givenergy.co.uk** immediately. Returns must be provided in original or equivalent packaging. The cardboard packaging is recyclable.

Item	Item Name	Function
A	DC MCB Breaker	Battery Isolator
B	ON/OFF Switch	System Switch
C	STATUS	Status Indicators
D	Earthing Point	Earth Bonding
E	Connection ports	Inverter connection
F	Dip Switches	Dip Switch

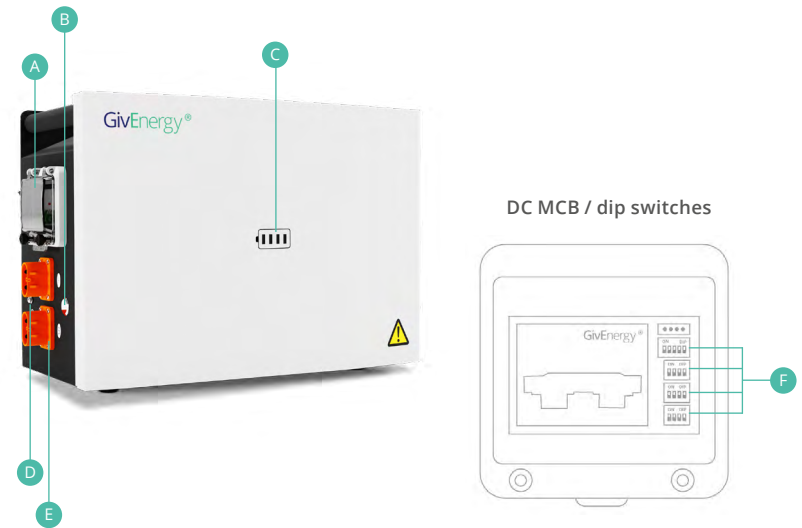

Two types of cables exist for connection to Gen 3 batteries;

### Lug to plug battery cable

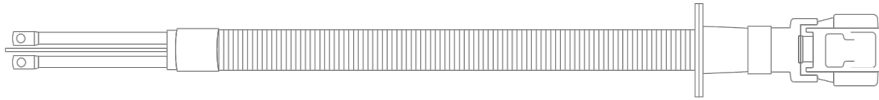

### Plug to plug battery cable



### IMPORTANT

All Generation 3 battery cables need to be purchased separately.

### Safety Instructions

Extra care and attention must be taken when installing and maintaining any GivEnergy equipment. The system is capable of lethal voltages, even when disconnected

- ✔ If you suspect something is wrong with the battery, contact GivEnergy on **01377 252 874** or email **support@givenergy.co.uk**.
- ✔ If any damaged or missing parts are found, please contact GivEnergy on **01377 252 874** or email **support@givenergy.co.uk** immediately. Returns must be provided in original or equivalent packaging. The cardboard packaging is recyclable.

### Installation Instructions

- ✔ All electrical installations must be carried out by a qualified and registered electrician and in accordance with the IEE Wiring Regulations
- ✔ Ensure batteries are always fixed to the wall using the mounting bracket, even when the weight of the product is on the floor
- ✔ All GivEnergy equipment must be installed by a **GivEnergy approved installer**
- ✔ Externally mounted batteries must always be wall mounted above the frost-line or a minimum of 50mm
- ✔ An earth bond must be installed between all batteries and inverters
- ✔ Do not remove the front cover unless instructed by the GivEnergy support team
- ✔ The ambient temperature for the installation of the battery system should be above - 10°C , below 5°C , and the humidity should be between 5% and 95%
- ✔ For outdoor installation, a canopy should be installed above the battery and should be installed in a well ventilated area



**Do not use the battery if there are any deformities, such as bulging or leakages**



**Do not puncture the battery**



**Do not throw the battery or use forceful impact**



**Do not attempt to repair the battery yourself (please call your Approved Installer)**



**The battery must be installed vertically, never install horizontally, avoid tilting the unit**

## STEP-BY-STEP INSTALLATION

Below is a list of the tools and equipment required to install the Giv-Bat 5.12:

- |                |                    |                  |
|----------------|--------------------|------------------|
| ✔ Drill bits   | ✔ Tape measure     | ✔ Safety goggles |
| ✔ Screw driver | ✔ Multimeter       | ✔ Safety shoes   |
| ✔ Socket set   | ✔ Spirit level     | ✔ Hammer         |
| ✔ Pencil       | ✔ Insulated gloves | ✔ T25 torx bit   |

1. Place the wall mounting bracket horizontally onto the wall and mark the position of the bracket holes. Ensure the wall is suitable to hold the weight of the battery.

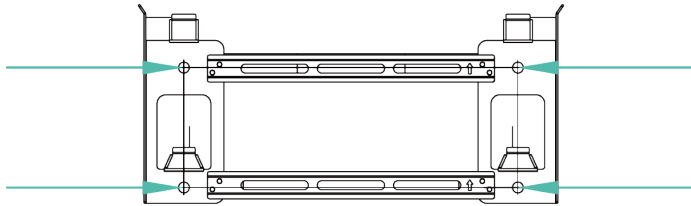

2. Drill 4 holes at the marked positions ensuring they are the sufficient depth for the fixings. Fix the mounting bracket to the wall using 4 expansion bolts.

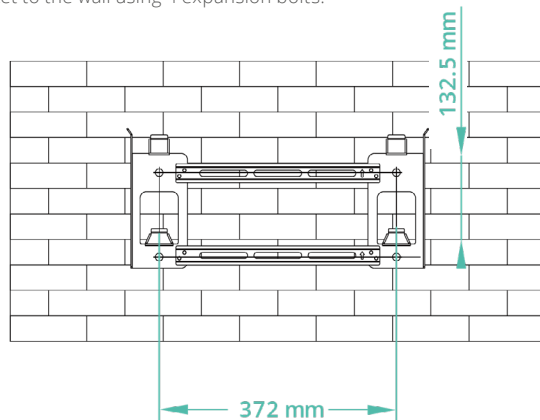

3. Mount the battery onto the mounting bracket.

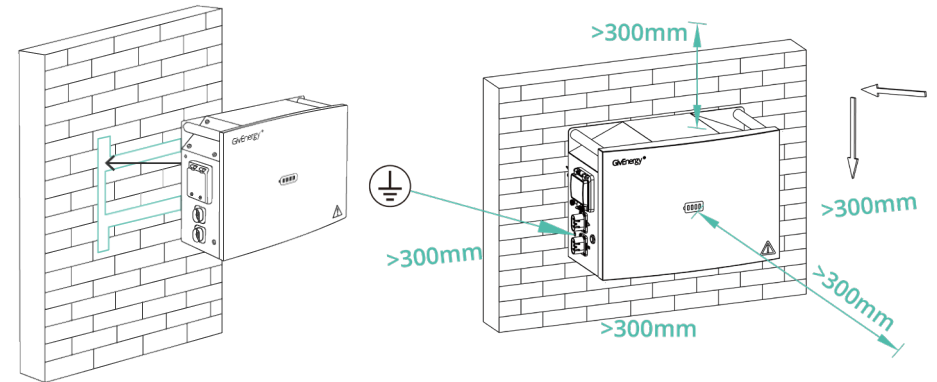

4. Place the battery against the wall and ensure it is above the wall mounted bracket. Slide the battery down and hang it on the bracket. Lock the safety screws on both sides of the battery.

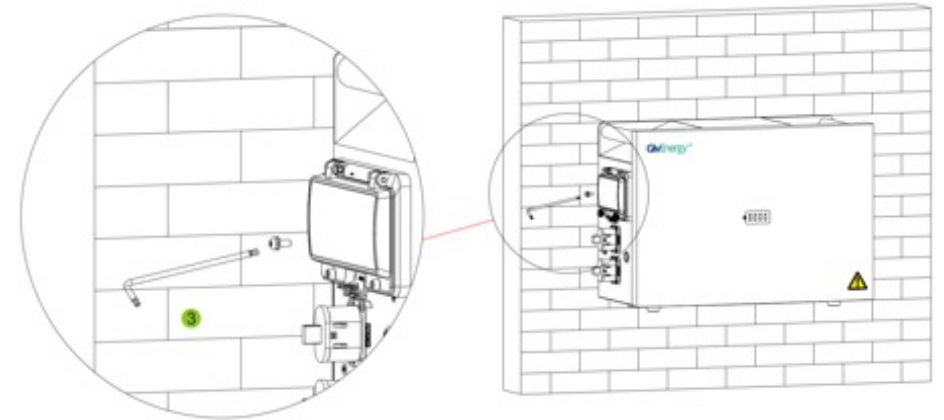

## STEP-BY-STEP INSTALLATION

### For Generation 1 Inverters only

- 4A.** Connect output A to the inverter using a lug to plug cable. If not connecting to additional battery packs, apply the blanking plug to output B.

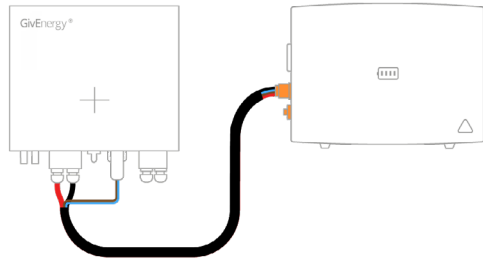

### For Generation 2 Inverters only

- 4B.** Connect output A to the inverter using a lug to plug cable. If not connecting to additional battery packs, apply the blanking plug to output B.

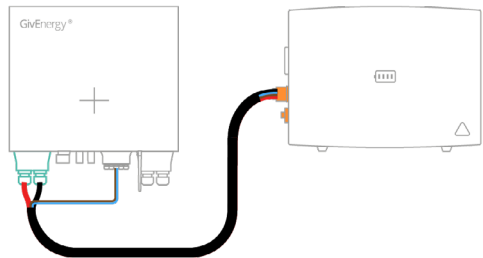

### For Generation 3 Inverters only

- 4C.** If connecting to Generation 3 inverter, use a plug to plug cable from output A of the Generation 3 battery to the connectors within the Generation 3 inverter.

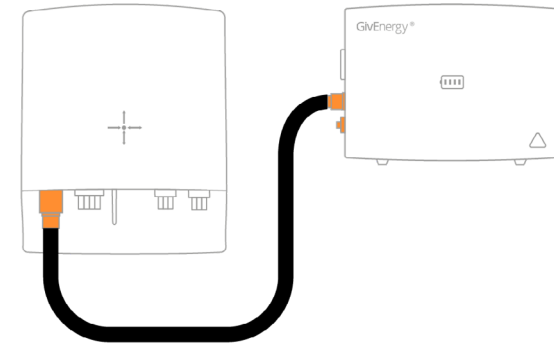

### For installing additional batteries

- 4D.** If connecting a G1/2 battery (5.2 or 2.6) to an existing G3 battery. Connect the Plug to Lug cable from the G3 battery connector B to the G1/2 battery terminals. Ensuring BMS communications cable has correct polarity. Ensure the G3 battery DIPs are set for Master and the G1/2 battery are set for Slave. A DC Isolator will be required to protect the slave battery(s).

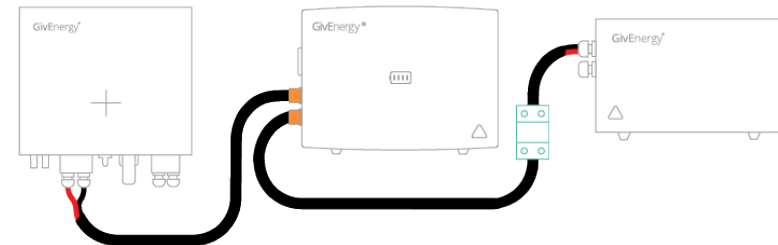

## STEP-BY-STEP INSTALLATION

- 4E. If connecting a Generation 2/3 battery to a Generation 2/3 battery use a plug to plug cable and connect from output B in your master battery into output A of your slave Generation 2 battery, and set your dip switches as per step 5 (below).

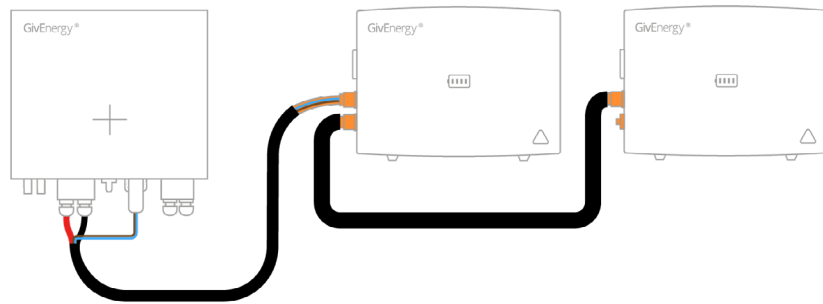

5. Set up the dipswitches on the circuit breaker, as shown overleaf.

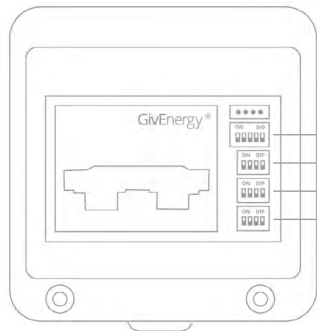

- SWITCH 4 - Master / Slave Dip Switch
- SWITCH 3 - Address Dip Switch
- SWITCH 2 - Address Dip Switch
- SWITCH 1 - Address Dip Switch

6. Push the 'On/Off' button on the right hand side of the battery, the LEDs will light up.
7. Commission the battery on the online portal and ensure the battery is operating normally.

## RS485 DIP SWITCH SETTINGS

### Master

Dip switch name	ID	Description
SW4		V V V V V
SW3		V V ^ ^
SW2		V V ^ ^
SW1		V V V V

### Slave 1

Dip switch name	ID	Description
SW4		V V V V V
SW3		V V ^ ^
SW2		V V ^ ^
SW1		^ V V V

### Slave 2

Dip switch name	ID	Description
SW4		V V V V V
SW3		V V ^ ^
SW2		V V ^ ^
SW1		V ^ V V

### Slave 3

Dip switch name	ID	Description
SW4		V V V V V
SW3		V V ^ ^
SW2		V V ^ ^
SW1		V V ^ V

### Slave 4

Dip switch name	ID	Description
SW4		V V V V V
SW3		V V ^ ^
SW2		V V ^ ^
SW1		V V V ^



- ▶ If any abnormalities are found during the process of powering on the battery, please immediately turn off the battery power. After solving the problem, turn on the battery again
- ▶ Make sure the inverter is turned off before checking the battery



### Power on

1. Switch the circuit breakers of all batteries to the "on" position
2. Switch on battery using button
3. The battery LED indicator lights up to indicate that the battery has been turned on

### Power off

Press the power button for 3 seconds to turn off the battery. During the process, the buzzer will sound for 1 second and the LED light will turn off. When multiple batteries need to be shut down in parallel, this action needs to be repeated.

Please close the waterproof cover of the circuit breaker and tighten the waterproof cover screws

### External USB battery



The USB of the battery can only be used for firmware upgrades. Please do not plug your phone or other electronic products into the USB of the battery for charging, otherwise the battery may be damaged.

1. Prepare a USB 2.0 interface USB flash drive in FAT32 format, storage space not exceeding 8GB;
2. Copy the battery firmware provided by the manufacturer to the root directory of the USB drive and delete all other files in the USB drive
3. Unscrew the fixing screws of the waterproof cover and open it, then set the dial switch according to the following diagram;
4. Insert the USB drive into the USB port of the battery, and the firmware will automatically update. After the SOC indicator light flashes alternately in red and green, the battery will automatically restart and the buzzer will sound once, indicating a successful upgrade.
5. After the upgrade is successful, unplug the USB flash drive, set the dial switch according to the following diagram, close the waterproof cover, and tighten the waterproof cover screws.



**1, 1**  
(USB Internal)



**0, 0**  
(USB External)

USB Mode

### Nameplate

This provides unique identification of the battery (product type, device-specific characteristics, certificates and approvals). The Nameplate is located on the right side of the battery.

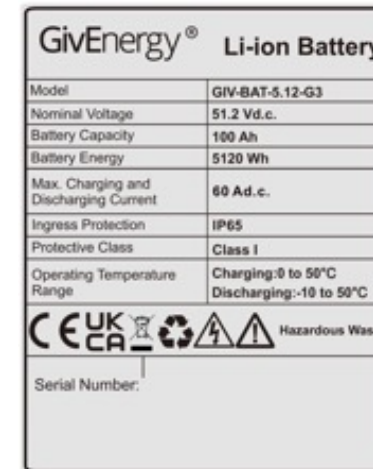

### Serial number

Located on the right side of the battery, the current battery serial number information.

SN: PBG XX X XXXX  
           ↓    ↓    ↓    ↓  
           1    2    3    4

Number	Paraphrase
1	Implication fixed coding
2	Year
3	Month
4	Journal number



## PORT FEATURES

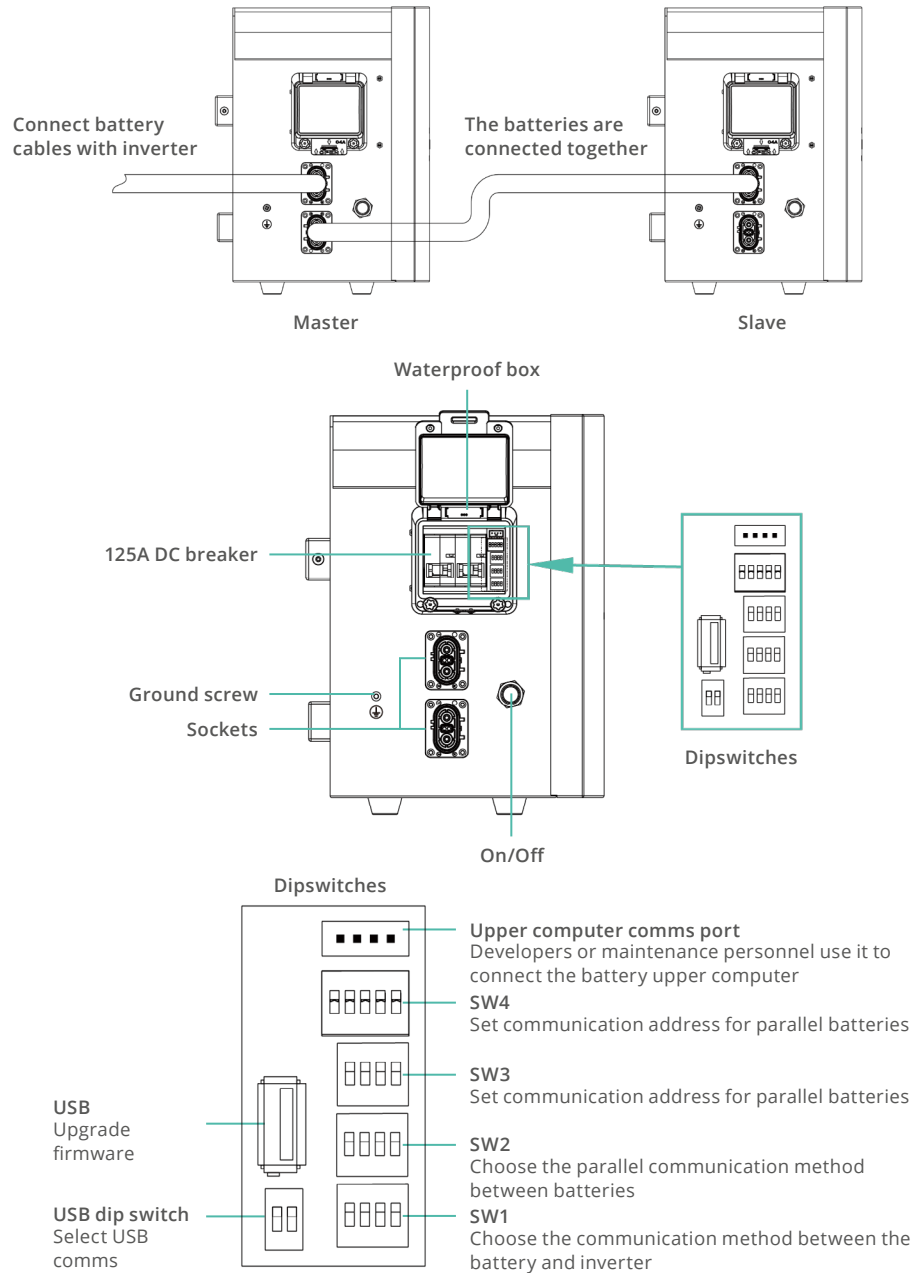

## STATUS INDICATORS

### Status Indicators

LED	Colour	Name	Description
	Green	SOC LED1	SOC 0%~25%
	Green	SOC LED2	SOC 26%~50%
	Green	SOC LED3	SOC 51%~75%
	Green	SOC LED4	SOC 76%~100%
	Red	SOC LED	Fault
	Green	Power button	Normal operation



### What does the STATUS light mean?

Off	Shut down
Green	Power is on
Green, flashing	Low battery energy
Flashing	Upgrading status
Red	Fault. Logged in system. If the light is red, call GivEnergy for remote diagnostics.

- **Battery on:** Press and hold the Battery button for 1s; the buzzer will sound for two seconds and the LED of battery switch will be green.
- **Battery off:** Press and hold the Battery button for 3s; the buzzer will sound for one seconds and the LED of battery switch will dim
- **Charge:** The Battery SOC in which range, the corresponding SOC LED The indicator is green and off at intervals of 1s
- **Low SOC:** When the SOC ranges from 0% to 5%, LED1 is flashes every 2 seconds
- **Upgrade:** The SOC LED Red-Green alternating

GivEnergy is the main supplier and manufacturer of the product. GivEnergy warrants that your product is (a) of acceptable quality and (b) does not have any latent defects.

- ✔ If you suspect something is wrong with the battery, contact GivEnergy on **01377 252 874** or email **support@givenergy.co.uk**.
- ✔ If any damaged or missing parts are found, please contact GivEnergy on **01377 252 874** or email **support@givenergy.co.uk** immediately. Returns must be provided in original or equivalent packaging. The cardboard packaging is recyclable.

## Products Covered



**Giv-Bat 5.12**  
12 years

## GIV-BAT 5.12

SKU	GIV-BAT-5.12-G3
Cell type	LiFePO <sub>4</sub> prismatic cell
Battery Capacity	5.12 kWh / 100 Ah
Battery Energy	5120Wh
Nominal Voltage	51.2V
Operating Voltage Range	44.8-57.6V
Cont. max. charging and discharging	60A/60A
Peak Current	120A@1s
Max charging and discharging power	3000W
Peak Power	6000W@1s
Beast Mode (Discharge) <sup>1</sup>	100A/5000W
Depth of discharge	100%
Operating voltage range	46.4V - 57.6V
Storage temperature	-30°C - 60°C
Dimension (W/H/D)	480x338x242(mm)
Weight	48±2kg
Cooling	Natural cooling
Communication Protocols	CAN/RS485
Humidity Range	5%-95%RH
Ingress Protection	IP65
Protective Class	1
Parallel quantity	Up to 5
Installation	Floor/Wall standing installation
Battery certification	IEC 62619/IEC 62040 /CE/UKCA/UN38.3 /CEC-AU
Battery Designation	IFpP/50/175/122/[1P16S]M/ -10+50/90

## APPENDIX | LED LIGHT DEFINITION

Status	Items	SOC indication				Remark
		LED1	LED2	LED3	LED4	
Charge SOC	0%-25%	● t=1s				The battery SOC; the corresponding SOC LED indicator will be green and off at intervals of 1S
	26%-25%	●	● t=1s			
	51%-75%	●	●	● t=1s		
	76%-99%	●	●	●	● t=1s	
	100%	●	●	●	●	
Discharge SOC	100%-76%	●	●	●	●	No special display status
	75%-51%	●	●	●		
	50%-26%	●	●			
	25%-0%	●				
Idle	100%-76%	●	●	●	●	When the SOC ranges from 0% to 5%, LED1 will be displayed in green and off for 2s
	75%-51%	●	●	●		
	50%-26%	●	●			
	25%-5%	●				
	5%-0%	● t=2s				

Parallel connection	Parallel connection succeeds	● t=0.8s	● t=0.8s	● t=0.8s	● t=0.8s	If the parallel is successful, the SOC LED will be green and off for 5S every 0.8S
Discharge SOC	Cell charge overvoltage protection			●		SOC LED light red
	Battery charge overvoltage protection			●		SOC LED light red
	Over charge and over discharge protection			●		SOC LED light red
	Cell discharge undervoltage protection			●		SOC LED light red
	Battery discharge undervoltage protection			●		SOC LED light red
	Discharge short circuit			●		SOC LED light red
	Voltage sampling fault			●		SOC LED light red
Charge/discharge overcurrent protection			●		SOC LED light red	

