

SAFETY

Safety and Advisory Symbols

	DANGER: This indicates a hazardous situation, which if not avoided, will result in death or serious injury.
	WARNING: This indicates a situation where failure to follow instructions may be a safety hazard or cause equipment malfunction. Use extreme caution and follow instructions carefully.
	NOTE: This indicates information particularly important for optimal system operation. Follow instructions carefully.

Safety Instructions

	DANGER: Risk of electric shock. Risk of fire. Do not attempt to repair the Envoy-S; it contains no user-serviceable parts. Tampering with or opening the Envoy-S will void the warranty. Warranty void if cover removed. If the Envoy-S fails, contact Enphase Customer Support for assistance (http://enphase.com/global/support-request/).
	DANGER: Risk of electric shock. Do not use Enphase equipment in a manner not specified by the manufacturer. Doing so may cause death or injury to persons, or damage to equipment.
	DANGER: Risk of electric shock. Be aware that installation of this equipment includes risk of electric shock. If you wire the Envoy-S at the sub-board, always de-energise the sub-board before beginning.
	DANGER: Risk of electric shock. Risk of fire. Only qualified personnel should troubleshoot, install, or replace the Envoy-S.
	DANGER: Risk of electric shock. Risk of fire. Do not wire unused terminals or terminal blocks on the Envoy-S.
	WARNING: Before installing or using the Envoy-S, read all instructions and cautionary markings in the technical description and on the Envoy-S.
	WARNING: Risk of equipment damage. If installing the Envoy-S in an enclosure, choose area for installation where ambient temperature does not exceed 46° C.
	NOTE: Perform all electrical installations in accordance with all national and local electrical codes.
	NOTE: To ensure optimal reliability and to meet warranty requirements, the Enphase Envoy-S must be installed according to the instructions in this manual.

Troubleshooting

a LED overview

LED	State	Description
All	Flashing amber in unison	The Envoy-S is booting up
	Flashing green sequentially	Software upgrade in progress
Network communications	Solid green	Communicating with Enlighten
	Flashing green	WPS connection in progress or the Envoy-S is attempting to connect to Enlighten
	Solid amber	Local network connection only
AP mode	Off	No network connection
	Solid green	AP mode enabled: Envoy Wi-Fi network available
	Off	AP mode disabled: Envoy Wi-Fi network unavailable
Power production	Solid green	All communicating microinverters are producing
	Flashing green	Microinverter upgrade in progress
	Solid Amber	At least one microinverter is not producing
Microinverter communications	Off	Microinverters are not communicating (low light or night time)
	Solid Green	All microinverters are communicating
	Flashing Green	Device scan in progress
Microinverter communications	Solid Amber	At least one microinverter is not communicating
	Off	Microinverters are not communicating (low light or night time)

b Microinverter detection issues

If the Microinverter Communications LED lights solid amber, it may be a result of low light levels. If there isn't enough sunlight to power up the microinverters, they can't communicate with the Envoy.

If there is sufficient daylight for the microinverters to power up, the issue may be that the Envoy is having difficulty communicating over the power lines. To troubleshoot this issue:

- Check the Installer Toolkit mobile app to see which microinverters are not communicating.
- Check that the circuit breaker(s) for the PV array are in the "ON" position.
- Verify that the PV modules are connected to the microinverters.
- Verify the PV module DC voltage is within the allowable range for the microinverter.

c Power production issues

If the Power Production LED lights solid amber, check the Installer Toolkit mobile app to see which microinverters are not producing:

- If none of the microinverters are producing power, there may be a grid or wiring issue. First, verify that there is proper input voltage and frequency from the grid. Next, check the breaker and wiring, starting at the switchboard.
- If all of the non-productive microinverters are on the same branch, check the breaker and wiring starting at the junction box for the affected branch.
- If only one or scattered microinverters are not producing power, first check to see that the AC connectors are fully seated in the Engage Cable connectors. Next, check that each module is providing the required startup voltage for the microinverter (22V). A PV module that is failing or that is undersized may not generate enough power for AC conversion.

d Internet connection issues

If you are using Wi-Fi and the Network Communications LED remains off:

- The WPS connection window may have timed out. Retry the connection steps.
- Make sure that the broadband router is operational by checking that other devices at the site can access the network.
- Be aware that metal enclosures or obstructions impede wireless communication.
- If you cannot see your router or access point in the list on the Envoy, or cannot maintain a connection, it may be necessary to add a wireless repeater to extend the network range.

If you are using Wi-Fi and the Network Communications LED lights solid amber, make sure that the broadband router is connected to the Internet by checking that other devices at the site can access the Internet.

If you are using the Enphase Mobile Connect modem and the Network Communications LED remains off or lights solid amber, see Troubleshooting in the *Enphase Mobile Connect Installation Guide*.

For any connection method, you can troubleshoot network issues with the Installer Toolkit mobile app by tapping the **Network** button, then **Diagnostic Tools**.

If you replace the broadband router, configure the Envoy Wi-Fi settings for the new Wireless Network Name (SSID) and password.

QUICK INSTALL GUIDE

(Models ENV-S-WB-230-F, -G, and -I)

Installing the Enphase Envoy-S Standard

To install the Enphase Envoy-S Standard™ gateway, read and follow all warnings and instructions in this Guide and in the *Enphase® Envoy-S Installation and Operation Manual* at: enphase.com/support. Safety warnings are listed on the back of this guide.

How It Works

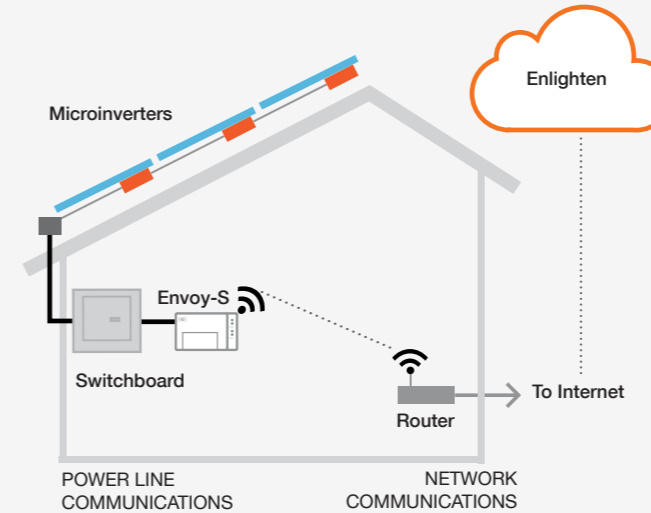

Envoy-S Display and Controls

Track system installation progress with the **Enphase Installer Toolkit** mobile app. The LEDs on the Envoy-S are solid green when a function is enabled or performing as expected, flashing when an operation is in progress, or solid amber when troubleshooting with Installer Toolkit is required. For a legend of all LED states, see *Troubleshooting*.

- Network Communications LED**
Green when Envoy-S is connected to Enlighten.
- AP Mode LED**
Green when Envoy's AP Wi-Fi network is available.
- AP Mode Button**
Press to enable Envoy's AP Mode for connecting with a mobile device. Hold for 5 seconds to start WPS connection to a router.
- Power Production LED**
Green when microinverters are producing power.
- Microinverter Communications LED**
Green when microinverters are communicating with Envoy-S.
- Device Scan Button**
Press to start/stop 15 minute scan for microinverters over the power line.

PREPARATION

- Download the latest version of the Enphase Installer Toolkit mobile app and open it to log in to your Enlighten account. With this app, you can connect to the Envoy-S to track system installation progress. To download, go to enphase.com/toolkit or scan the QR code at right.
 
- Check the box for the following items:
 - Enphase Envoy-S Standard gateway
 - AC power cord
 - Length of DIN rail for mounting
 - Ferrite bead to attach to your Ethernet Cable, if used
- Decide whether to power the Envoy-S using the included AC power cord or by hard-wiring it in an enclosure. If you hard-wire the Envoy-S, you must install it in a non-metallic, IP54-rated, or better enclosure (use an appropriately rated enclosure if hard wiring the Envoy-S indoors) with conduit attachment. Do not drill holes on the top of the enclosure or anywhere that allows moisture ingress. If you use the power cord in an enclosure, the socket must be appropriately rated.
- If you are installing the Envoy-S in a multi-phase application, install a phase coupler on the load side of the over-current protection device. See the Technical Brief on Phase Coupling for your region at enphase.com/support. Consult Enphase support for compatible devices.
- Decide how to connect the Envoy-S to the Internet: Wi-Fi, an Enphase Mobile Connect modem, or Ethernet.
- Make sure you have the following optional items, if needed:
 - Enphase Mobile Connect modem (order CELLMODEM-02)
 - Ethernet over power line communication (PLC) bridge with Ethernet cables [order EPLC-02 (EU), EPLC-03 (UK) or EPLC-04 (AU)]
 - Ethernet cable (802.3, Cat5E or Cat6, unshielded)
- Install the PV modules and microinverters as directed by the installation manuals.
- Create a paper installation map to record microinverter serial numbers and positions in the array. You will scan this map later using Installer Toolkit and your mobile device.
 - Peel the removable serial number label from each microinverter and affix it to the respective location on the paper installation map.
 - Peel the removable label from the bottom of the Envoy-S and affix it to the paper installation map.
 - Always keep a copy of the installation map for your records and to upload to Enlighten later.

Note: If needed, you can find an installation map at the back of any *Enphase Microinverter Quick Install Guide*.

INSTALLATION

1 Choose a location for the Envoy-S

- Install the Envoy-S in a dry location near the switchboard. If installing indoors, choose a protected space. If installing outdoors, you must install it inside an IP54-rated, or better enclosure with conduit attachment.

NOTE: Metallic enclosures may impair Wi-Fi signal strength.

- Mount the Envoy horizontally using the included DIN rail.

2 Provide a Power Connection

You can use the included AC power cord or terminal blocks to provide a power connection for the Envoy-S. If you wire the terminal block connections, you must use a protected route using conduit for the wires to the Envoy-S.

Method A // Use the included power cord

- Locate an AC socket that is indoors (or outdoors in an IP54-rated enclosure) and close to the switchboard. If outdoors, the socket must be appropriately rated.
- Plug the AC power cord into the AC inlet on the Envoy-S.
- Plug the other end of the power cord into a dedicated 230 VAC socket (not a power board).

Method B // Hardwire the Envoy-S for power

- Use a single-pole/Ph+N, 20 A maximum circuit breaker for the supply wiring.
- Make sure supply wiring is 1.5mm² rated at 75 degrees C or better.
- Locate the screw on the left side of the terminal block door, and loosen it with a screwdriver to unlock the door.
- Flip open the terminal block door and move the shutter to the left. Connect Line (active) to A and Neutral to N. Tighten to 0.56 Nm.
- Close the terminal block door, and secure it with the screw.
- Turn on the circuit feeding the Envoy-S.

With all methods

All four LEDs flash amber during boot up (approximately 3 minutes). When boot up is complete, the Microinverter Communications LED  lights solid amber, indicating that microinverters are not yet detected.

Do not plug the Envoy-S into a power board, surge protector, or uninterruptible power supply (UPS). These devices impede power line communications.

DANGER! Risk of electric shock. Always de-energise circuits before beginning wiring.

If you are installing the Envoy-S in a multi-phase application, install a phase coupler on the load side of the over-current protection device. For more information, see the Technical Brief on Phase Coupling for your region at enphase.com/support.

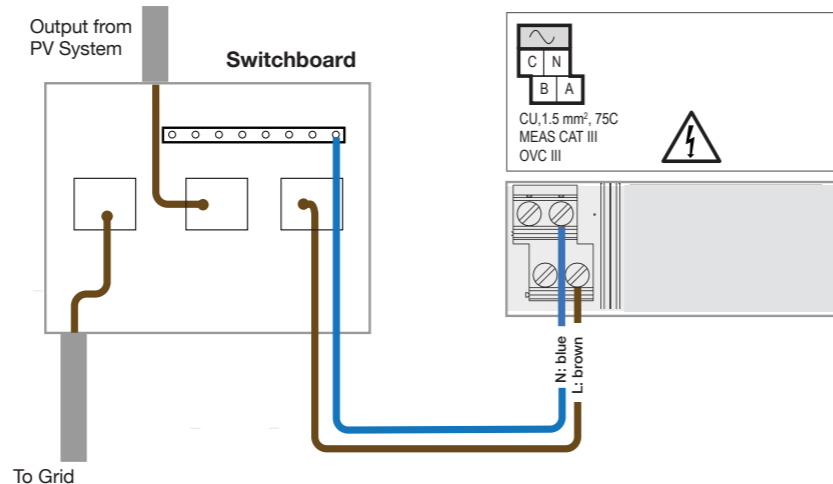

3 Detect Microinverters

Use one of the following methods to detect microinverters.

Method A // Provision microinverters with Installer Toolkit

Use the Installer Toolkit mobile app to configure the Envoy-S with the serial numbers of the installed microinverters.

- Launch Installer Toolkit and tap **View Systems**.
- Select the system you are working with, or tap **[+]** to add a system.
- Connect to the Envoy-S with your mobile device as described in the note at the bottom of this page.
- Return to Installer Toolkit. If the serial number for the Envoy-S you are installing is not displayed on the System Overview screen, tap the **[+]** next to the word "Envoys". When the app displays the serial number of the Envoy-S, tap it to add it to the system.
- Create the arrays and use your mobile device to scan the serial numbers from the installation map as instructed by the *Installer Toolkit Operation Manual* at enphase.com/support.
- Tap the **Connect** button. This provisions the scanned microinverters on the Envoy-S.
- When prompted, confirm the number of microinverters that you installed.

The Microinverter Communications LED lights solid green if all of the provisioned devices are communicating or solid amber if any devices are not communicating.

Method B // Discover microinverters with Installer Toolkit

Use the Installer Toolkit mobile app to set the number of microinverters the Envoy-S should search for on the power line.

- Connect to the Envoy-S with your mobile device as described in the note at the bottom of this page.
- Launch Installer Toolkit and tap **Connect to an Envoy**.

- When prompted, enter the number of microinverters that you installed.
- When prompted to start a device scan, tap **OK**.

The Microinverter Communications LED flashes green while scanning. It lights solid green when all of the microinverters you installed are communicating or solid amber if any devices are not communicating.

Method C // Discover microinverters with the Envoy-S

If you are not using the Installer Toolkit app, press the Device Scan button on the Envoy-S. With this method, the Envoy searches the power line for 15 minutes, but does not know how many microinverters it should discover.

The Microinverter Communications LED flashes green for 15 minutes while scanning. At the end of the scan, it lights solid green if at least one microinverter was discovered or solid amber if no microinverters were discovered (or if any discovered microinverter stops communicating).

With all methods

If the Microinverter Communications LED remains solid amber, see *Troubleshooting* .

Note: Connecting to Envoy-S with a Mobile Device



The Envoy's AP (Access Point) Wi-Fi network allows you to connect your mobile device (smart phone or tablet) to the Envoy-S. The AP Mode LED  lights solid green when the network is available.

- On the Envoy-S, if the AP Mode LED is not lit, press the AP Mode button.
- On your mobile device, go to Settings and join the Wi-Fi network "Envoy_nnnnnn" (where "nnnnnn" represents the final six digits of the Envoy serial number).

4 Verify System Configuration

While still connected to the Envoy-S with Installer Toolkit, check the Overview screen for the following:

- Confirm that the expected number of devices are detected and communicating.
- Tap the **Grid Profile** row on the Overview screen to select and apply a grid profile to the microinverters. On the Overview screen, check that the new profile is set on all the microinverters. This may take up to 5 minutes for a typical system.

If you used Installer Toolkit to detect microinverters, the Power Production LED  lights solid green when all expected microinverters are producing power. If you did not use Installer Toolkit, it lights solid green if all communicating microinverters are producing power. It flashes green when microinverters are upgrading. Check Installer Toolkit for production status details. If the Power Production LED remains solid amber, see *Troubleshooting* .

5 Connect to Enlighten



WARNING: Do not remove power from the Envoy-S if the LEDs are flashing green. This indicates that a software upgrade is in progress.

This section describes using the Envoy-S integrated Wi-Fi or the Mobile Connect modem. For information about using Ethernet PLC bridges, refer to the *Enphase Envoy-S Installation and Operation Manual* at: enphase.com/support.

Method A // Integrated Wi-Fi

Requires a wireless router with an Internet connection.



- On the Envoy-S, verify that no Ethernet cable is plugged into the RJ45 port.
- If the router supports WPS, press and hold the WPS button on the wireless router for a few seconds. On most routers, a WPS indicator begins flashing.
- If you are using the Installer Toolkit mobile app, tap the **Network** button, tap **Wi-Fi**, and then tap your network from the list of available networks. If the wireless router does not support WPS, you may be prompted to enter a password.

If you are not using the Installer Toolkit mobile app, initiate a WPS connection by pressing and holding the Envoy-S AP Mode button for 5 seconds.

The Network Communications LED  begins flashing green. Within three minutes the Network Communications LED lights solid green, indicating a successful connection to Enlighten. If the Network Communications LED remains off or lights solid amber, see *Troubleshooting* .

Method B // Enphase Mobile Connect Modem

(Order CELLMODEM-02 separately)

- Connect the antenna to the antenna connector (marked CELL) on the modem.
- Mount the modem as described in the *Enphase Mobile Connect Installation Guide*.
- Connect the micro-USB cable to the modem and connect the other end of the cable to the Envoy-S. If receiving power from the Envoy-S, the modem power LED lights.

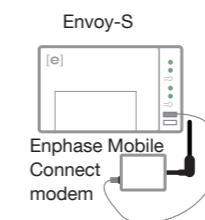

Within three minutes the Network Communications LED lights solid green, indicating a successful connection to Enlighten. If the Network Communications LED remains off or lights solid amber, see *Troubleshooting* in the *Enphase Mobile Connect Installation Guide*.

6 Send System Summary Report

When you have completed your system setup, you can generate and email a summary report.

- From Installer Toolkit, tap **Done** in the upper-right corner of the screen to disconnect from the Envoy. Installer Toolkit will ask if you want to view a summary report.
- Tap **View Report**. The report displays Envoy and system information with a list of microinverter serial numbers, their last power reports, and information about the grid profile applied to the microinverters.
- Tap  to email the report as needed as a record of successful system installation and for evidence of grid profile settings.

Note: If you connect to an Envoy after associating it to a system, the report includes a system name and address. For more information, refer to the *Enphase Installer Toolkit Operation Manual* at: enphase.com/support.

ACTIVATE MONITORING

Register the Envoy-S in Enlighten (enlighten.enphaseenergy.com).

Method A // If the Envoy-S is associated with a system in Installer Toolkit

- On your mobile device, go to Settings and disconnect from the Envoy's Wi-Fi network.
- Return to the Installer Toolkit app and tap the **Sync** button on the System Overview screen.
- When you have access to a computer, log in to Enlighten and select the system name from the Activation List on the dashboard.

D) From the activation form, open Array Builder.

If you used Installer Toolkit to build arrays and scan microinverter serial numbers, the array(s) are built—make any necessary adjustments in Array Builder.

If you did NOT use Installer Toolkit to build arrays and scan microinverter serial numbers, create the virtual array in Array Builder, using the installation map as your reference. (You may need to wait if the microinverters have not yet reported to Enlighten.)

Method B // If the Envoy-S is NOT associated with a system in Installer Toolkit

- Log into Enlighten and click **Add a New System** from the dashboard.
- Enter the System, Installer, Owner, and Location information.
- Enter the Envoy serial number.
- Click **Save** to submit the form.
- After the microinverters have reported to Enlighten, open Array Builder from the activation form, and create the virtual array using the installation map as your reference.