



X1-Hybrid-G4

3.0 kW / 3.7 kW / 5.0 kW / 6.0kW / 7.5kW

User Manual

Version 3.0

www.solaxpower.com



eManual in the QR code or
at <http://kb.solaxpower.com/>

STATEMENT

Copyright

Copyright © SolaX Power Network Technology (Zhejiang) Co., Ltd. All rights reserved.

No part of this manual may be reproduced, transmitted, transcribed, stored in a retrieval system, or translated into any language or computer language, in any form or by any means without the prior written permission of SolaX Power Network Technology (Zhejiang) Co., Ltd.

Trademarks



SOLA^X and other symbol or design (brand name, logo) that distinguishes the products or services offered by SolaX has been trademark protected. Any unauthorized use of the above stated trademark may infringe the trademark right.

Notice

Please note that certain products, features, and services mentioned in this document may not be within the scope of your purchase or usage. Unless otherwise specified in the contract, the contents, information, and recommendations presented in this document are provided "as is" by SolaX. We do not provide any warranties, guarantees, or representations, whether express or implied.

The content of the documents is reviewed and updated as needed. However, occasional discrepancies may occur. SolaX retains the right to make improvements or changes in the product(s) and the program(s) described in this manual at any time without prior notice.

The images included in this document are solely for illustrative purposes and may differ based on the specific product models.

For more detailed information, kindly visit the website of SolaX Power Network Technology (Zhejiang) Co., Ltd. at www.solaxpower.com.

SolaX retains all rights for the final explanation.

About This Manual

Scope of Validity

This manual is an integral part of X1-Hybrid G4 series inverter. It describes the transportation, storage, installation, electrical connection, commissioning, maintenance and troubleshooting of the product. Please read it carefully before operating.

This manual is valid for the following inverter models:

- X1-Hybrid-3.0-D/M
- X1-Hybrid-3.7-D/M
- X1-Hybrid-5.0-D/M, X1-Hybrid-5.0K-D*
- X1-Hybrid-6.0-D/M
- X1-Hybrid-7.5-D/M

Model description

X1-Hybrid-3.0-D/M

1

2

3

Item	Meaning	Description
1	Product family name	"X1-Hybrid": energy storage series inverter that supports grid connection of photovoltaic system.
2	Power	"3.0": rated output power of 3 kW.
3	Version	"D": with DC switch. "M": externally attached X1-Matebox for full load EPS(Off-grid) operation.
*	5.0K-D	"5.0K-D": in compliance with C10/11.



Target Group

The installation, maintenance and grid-related setting can only be performed by qualified personnel who:

- Are licensed and/or satisfy state and local regulations.
- Have good knowledge of this manual and other related documents.

Conventions

The symbols that may be found in this manual are defined as follows.

Symbol	Description
 DANGER	Indicates a hazardous situation which, if not avoided, will result in death or serious injury.
 WARNING	Indicates a hazardous situation which, if not avoided, could result in death or serious injury.
 CAUTION!	Indicates a hazardous situation which, if not avoided, could result in minor or moderate injury.
NOTICE!	Provides tips for the optimal operation of the product.

Change History

Version 03 (2024-08-08)

Updated user manual to a new format

Version 02 (2023-12-25)

Updated 8.8 Monitoring Connection (Modified WiFi+Lan Mode)

Version 01 (2023-11-15)

Updated 2.7 Working Mode (Added TOU mode)

Version 0.0 (2023-09-20)

Initial release

Table of Contents

1	Safety	1
1.1	General Safety	1
1.2	Safety Instructions of PV, Inverter and Grid	1
1.2.1	Safety Instructions of PV	2
1.2.2	Safety Instructions of Inverter	2
1.2.3	Safety Instructions of Utility Grid	3
2	Product Overview	4
2.1	Product Introduction	4
2.2	Appearance	4
2.3	Supported Power Grid	5
2.4	Symbols on the Label and Inverter	6
2.5	Working Principle	7
2.5.1	Circuit Diagram	7
2.5.2	Application Schemes	8
2.6	Working State	10
2.7	Working mode	11
2.7.1	Self Use Mode (Priority: Loads > Battery > Grid)	11
2.7.2	Feed-in Priority (Priority: Loads > Grid > Battery)	13
2.7.3	Backup Mode (Priority: Loads > Battery > Grid)	14
2.7.4	Peak Shaving Mode	16
2.7.5	TOU Mode	17
2.7.6	EPS (Off-grid) Mode (Priority: Loads > Battery)	18
2.7.7	Manual Mode	19
3	System Overview	20
4	Transportation and Storage	23
5	Preparation before Installation	24
5.1	Selection of Installation Location	24
5.1.1	Environment Requirement	24
5.1.2	Installation Carrier Requirement	26
5.1.3	Clearance Requirement	27
5.2	Tools Requirement	28
5.3	Additionally Required Materials	29
6	Unpacking and Inspection	30

6.1	Unpacking.....	30
6.2	Scope of Delivery.....	31
7	Mechanical Installation	34
7.1	Dimensions for mounting	35
7.2	Installation procedures	36
8	Electrical Connection	38
8.1	Overview of Electrical Connection	39
8.1.1	Terminals of Inverter.....	39
8.1.2	Cable Connections of Inverter.....	40
8.2	PE Connection	42
8.3	AC Connection.....	45
8.4	PV Connection	49
8.5	Battery Power Cable Connection.....	55
8.6	COM Communication Connection (Meter/CT)	58
8.6.1	Pin assignment of Meter/CT terminal	58
8.6.2	Meter/CT Connection.....	59
8.6.3	Meter/CT Wiring procedure	60
8.7	COM Communication Connection (BMS/CAN/COM/LCD/DRM).....	63
8.7.1	BMS Communication Connection	64
8.7.2	CAN Connection (Parallel Connection).....	65
8.7.3	COM/LCD Communication Connection.....	65
8.7.4	DRM Connection (Applicable to AS/NZS 4777.2)	65
8.7.5	BMS/CAN/COM/LCD/DRM Wiring procedure.....	66
8.8	Monitoring Connection.....	68
9	System Commissioning	71
9.1	Checking before Power-on	71
9.2	Powering on the System.....	71
9.3	Lockable DC Switch.....	72
10	Operation on LCD.....	74
10.1	Introduction of Control Panel.....	74
10.2	Introduction of Menu Interface	76
10.3	System ON/OFF.....	79
10.4	Work Mode	79
10.5	System Status	81
10.6	History Data.....	83
10.7	Setting	85
10.7.1	User Setting.....	85

10.7.2	Advanced Setting	92
10.8	About.....	111
11	Operation on SolaX App and Web.....	112
11.1	Introduction of SolaXCloud.....	112
11.2	Operation Guide on SolaXCloud App	112
11.2.1	Downloading and Installing App	112
11.2.2	Operations on App	113
11.3	Operations on SolaXCloud Webpage.....	113
12	Troubleshooting and Maintenance	114
12.1	Power off.....	114
12.2	Troubleshooting.....	114
12.3	Maintenance.....	123
12.3.1	Maintenance routines	123
12.3.2	Upgrading Firmware.....	124
13	Decommissioning	126
13.1	Disassembling the Inverter	126
13.2	Packing the Inverter	129
13.3	Disposing of the Inverter	129
14	Technical Data	130
15	Appendix	134
15.1	Application of Generator.....	134
15.1.1	Introduction of generator application	134
15.1.2	Notice for generator application	134
15.1.3	ATS control mode	134
15.1.4	Dry contact mode.....	136
15.2	Application of Adapter Box G2	139
15.2.1	Introduction of Adapter Box G2 application	139
15.2.2	Wiring connection diagram	139
15.2.3	Communication connection with inverter.....	140
15.2.4	Settings for Adapter Box G2	141
15.3	Application of EV-Charger	142
15.3.1	Introduction of EV-Charger application.....	142
15.3.2	Wiring connection diagram	142
15.3.3	Communication connection with inverter.....	143
15.3.4	Setting for EV-Charger.....	144
15.4	Application of DataHub	145
15.4.1	Introduction of DataHub application	145

15.4.2	Wiring connection diagram	145
15.4.3	Communication connection with inverter.....	146
15.4.4	Settings for DataHub.....	147
15.5	Application of Micro-grid	148
15.5.1	Introduction of Micro-grid application	148
15.5.2	Wiring connection diagram	148
15.5.3	Working modes.....	149
15.5.4	Cable connection (Hybrid inverter)	149
15.5.5	Cable connection (On-grid inverter).....	149
15.6	Application of Parallel Function	150
15.6.1	Introduction of parallel application.....	150
15.6.2	Notice for parallel application	150
15.6.3	System wiring diagram	151
15.6.4	System wiring procedure	151
15.6.5	Settings for parallel connection.....	153
15.7	Application of Meter/CT	155
15.7.1	CT/Meter Connection Scenarios.....	155
15.7.2	Connection of CT	155
15.7.3	Connection of Direct-connected Meter	158
15.7.4	Connection of CT-connected Meter	161
15.7.5	Connection of Two Meters	164

1 Safety

1.1 General Safety

The series inverter has been meticulously designed and thoroughly tested to comply with the relevant state and international safety standards. Nevertheless, like all electrical and electronic equipment, safety precautions must be observed and followed during the installation of the inverter to minimize the risk of personal injury and ensure a safe installation.

Please thoroughly read, comprehend, and strictly adhere to the comprehensive instructions provided in the user manual and any other relevant regulations prior to the installation of the inverter. The safety instructions in this document serve as supplementary guidelines to local laws and regulations.

SolaX shall not be liable for any consequences resulting from the violation of the storage, transportation, installation, and operation regulations outlined in this document. Such consequences include, but are not limited to:

- Inverter damage caused by force majeure events, such as earthquakes, floods, thunderstorms, lightning, fire hazards, volcanic eruptions, and similar events.
- Inverter damage due to human causes.
- Usage or operation of the inverter in violation of local policies or regulations.
- Failure to comply with the operation instructions and safety precautions provided with the product and in this document.
- Improper installation or usage of the inverter in unsuitable environmental or electrical conditions.
- Unauthorized modifications to the product or software.
- Inverter damage occurring during transportation by the customer.
- Storage conditions that do not meet the requirements specified in this document.
- Installation and commissioning performed by unauthorized personnel who lack the necessary licenses or do not comply with state and local regulations.

1.2 Safety Instructions of PV, Inverter and Grid

Save these important safety instructions. Failure to follow these safety instructions may result in damage to the inverter and injury or even loss of life.

1.2.1 Safety Instructions of PV

 **DANGER!**

Potential risk of lethal electric shock associated with the photovoltaic (PV) system

- Exposure to sunlight can result in the generation of high DC voltage by PV modules, which can lead to electric shock causing severe injuries or even death.
- Never touch the positive or negative poles of the PV connecting device, and avoid touching both poles simultaneously.
- Do not ground the positive or negative poles of the PV modules.
- Only qualified personnel can perform the wiring of the PV modules.

 **WARNING!**

- Overvoltage protection with surge arresters should be provided when the PV system is installed. The inverter is fitted with SPDs on both PV input side and MAINS side.
- Please consult professionals before installing SPDs.

 **WARNING!**

- Make sure that the input DC voltage does not exceed the maximum DC input voltage specified for the inverter. Overvoltage can cause irreversible damage to the inverter, and such damage is not covered by the warranty.

1.2.2 Safety Instructions of Inverter

 **DANGER!**

Potential risk of lethal electric shock associated with the inverter

- Only operate the inverter if it is in a technically faultless condition. Operating a faulty inverter may lead to electric shock or fire.
- Do not attempt to open the enclosure without authorization from SolaX. Unauthorized opening of the enclosure will void the warranty and can result in lethal danger or serious injury due to electric shock.
- Make sure that the inverter is reliably grounded before any operation to prevent the risk of electric shock causing lethal danger or serious injury.
- Only qualified personnel can perform the installation, wiring, maintenance of the inverter by following this document and the related regulations.

 **WARNING!**

- During operation, avoid touching any parts of the inverter other than the DC switch and LCD panel (if any).
- Never connect or disconnect the AC and DC connector while the inverter is running.
- Prior to conducting any maintenance, turn off the AC and DC power and disconnect them from the inverter. Wait for 5 minutes to fully discharge the energy.

 **WARNING!****Potential danger of scalding due to the hot enclosure of the inverter**

- Avoid touching the inverter while it is running, as it becomes hot during operation and may cause personal injuries.

 **WARNING!**

- When handling the battery, carefully follow all safety instructions provided in the battery manual. The battery used with the inverter must meet the specified requirements of the series inverter.

 **WARNING!**

- Use insulated tools when installing the device, and always wear personal protective equipment during installation and maintenance.

 **CAUTION!**

- Make sure that children are supervised to prevent them from playing with the inverter.
- Pay attention to the weight of the inverter and handle it properly to avoid personal injuries.

NOTICE!

- If an external Residual Current Device (RCD) is required by local regulations, verify the type of RCD required. It is recommended to use a Type-A RCD with a rating of 300 mA. When required by local regulations, the use of a Type-B RCD is permitted.
- Keep all product labels and the nameplate on the inverter clearly visible and well-maintained.

1.2.3 Safety Instructions of Utility Grid

NOTICE!

- Only connect the inverter to the grid with the permission of the local utility grid company.

2 Product Overview

2.1 Product Introduction

The X1-Hybrid G4 series is an energy storage PV grid-connected inverter that can convert solar energy into alternating current and store energy into batteries. The inverter can be used to optimize self-consumption, stored in batteries for future use or fed into the public grid. The way it works depends on user preferences. It can provide emergency power during power outages.

2.2 Appearance

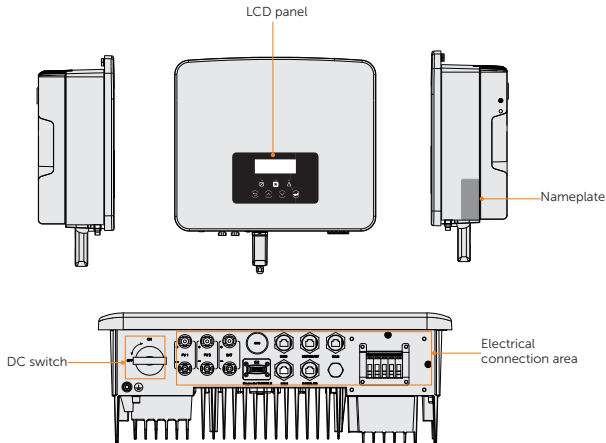

Figure 2-1 Appearance

Table 2-1 Description of appearance

Item	Description
Nameplate	Nameplate clearly identifies the device type, serial number, specific DC / AC parameters, certification, etc.
LCD panel	Including screen, indicators and keys. Screen displays the information; indicators indicate the status of inverter. Keys are used to perform the parameter setting.
DC switch	Disconnect the DC input when necessary.

Electrical connection area Including PV terminals, battery terminals, grid terminals, EPS (Off-grid) terminals, communication terminals, etc.

2.3 Supported Power Grid

There are different ways of wiring for different grid systems. TT / TN-S / TN-C-S are shown as below:

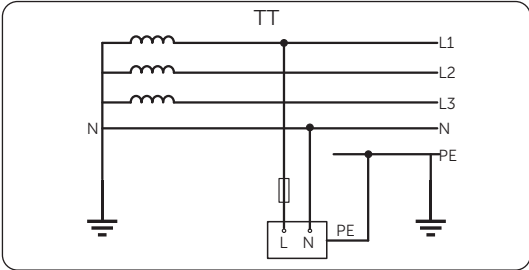

Figure 2-2 Supported power grid-TT

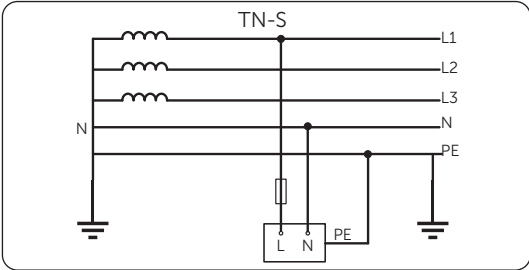

Figure 2-3 Supported power grid-TN-S

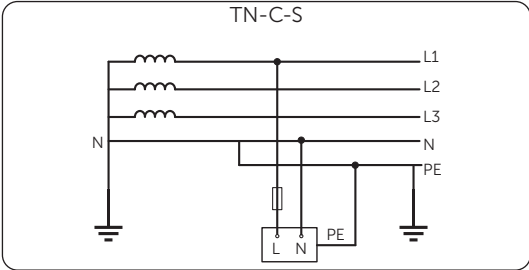













Figure 2-4 Supported power grid-TN-C-S

2.4 Symbols on the Label and Inverter

Table 2-2 Description of symbols

Symbol	Description
	CE mark. The inverter complies with the requirements of the applicable CE guidelines.
	TUV certified.
	RCM mark. The inverter complies with the requirements of the applicable RCM guidelines.
	Additional grounding point.
	Beware of hot surface. Do not touch a running inverter, as the inverter becomes hot during operation!
	Risk of electric shock. High voltage exists after the inverter is powered on!
	Risk of danger. Potential hazards exist after the inverter is powered on!
	Read the enclosed documentations.
	Do not dispose of the inverter together with household waste.
	Do not operate this inverter until it is isolated from battery, mains and on-site PV generation source.
	Danger of high voltage. Do not touch live parts for 5 minutes after disconnection from the power sources.

2.5 Working Principle

2.5.1 Circuit Diagram

The inverter is equipped with multi-channel MPPT for DC input to ensure maximum power even under different photovoltaic input conditions. The inverter unit converts direct current into alternating current that meets the requirements of the power grid and feeds it into the power grid. The principle design of inverter is shown in the figure below:

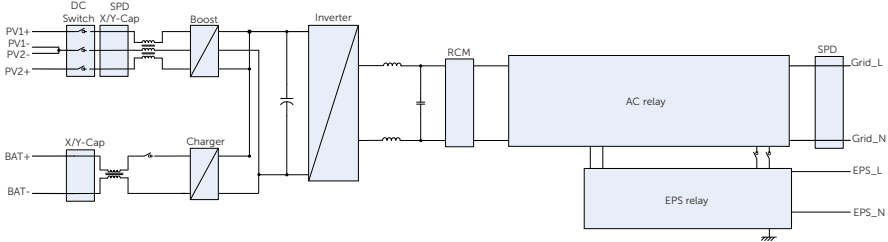

Figure 2-5 Circuit diagram for X1-Hybrid G4 series inverter

2.5.2 Application Schemes

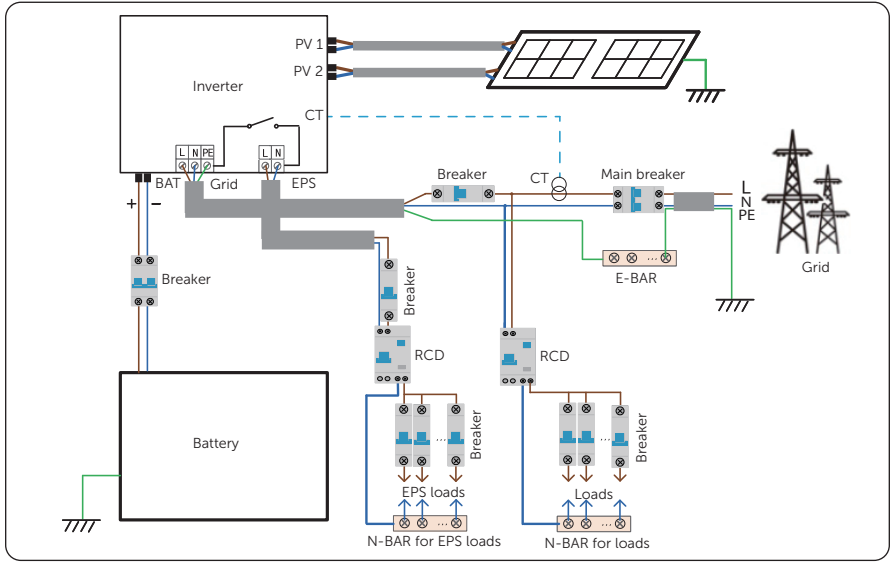

Figure 2-6 Partial home backup for Europe

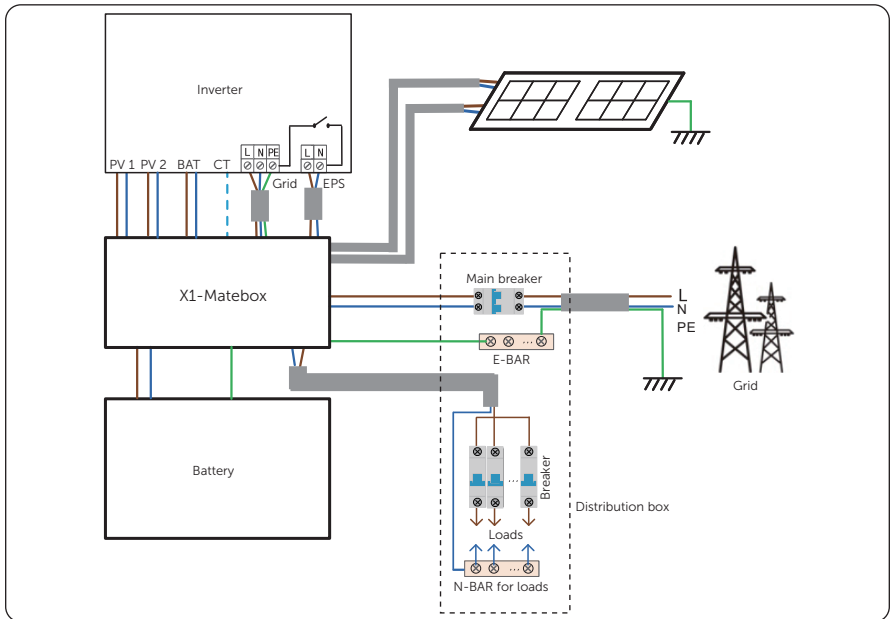

Figure 2-7 Whole home backup for Europe

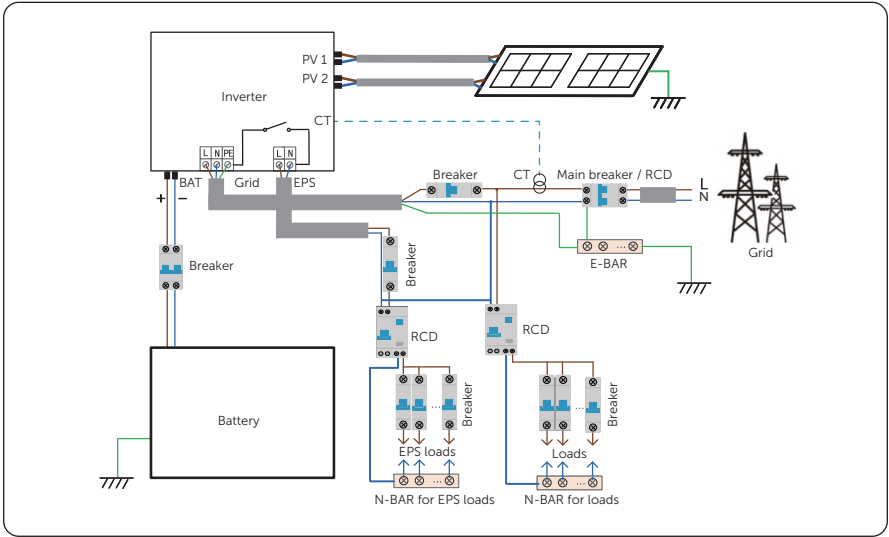

Figure 2-8 Partial home backup for Australia

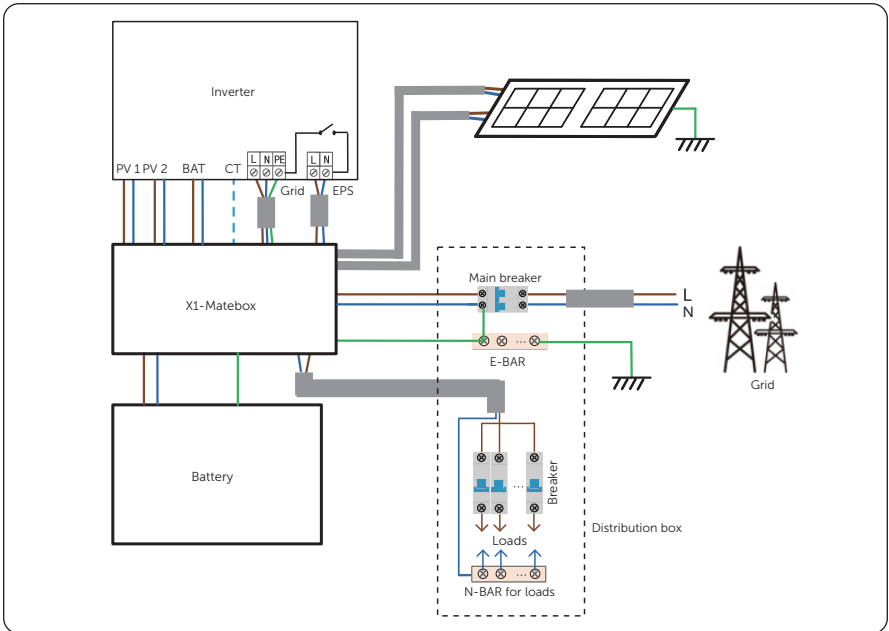

Figure 2-9 Whole home backup for Australia

2.6 Working State

The series inverter has Waiting, Checking, Normal, EPS Waiting, EPS, Fault, Idle and Standby state.

Table 2-3 Description of working state

State	Description
Waiting	<ul style="list-style-type: none"> The inverter is waiting for the conditions to be met in order to enter Checking state.
Checking	<ul style="list-style-type: none"> The inverter is checking for conditions to enter Normal state.
Normal	<ul style="list-style-type: none"> The inverter is working normally.
EPS Waiting	<ul style="list-style-type: none"> The inverter is waiting for conditions to enter EPS state.
EPS	<ul style="list-style-type: none"> The inverter is working in off-grid state.
Fault	<ul style="list-style-type: none"> The inverter detects error and prompts error code.
Idle	<ul style="list-style-type: none"> When the battery SOC reaches the minimum SOC and there is no sufficient PV input voltage, the battery goes into hibernation and the inverter enters Idle state.
Standby	<ul style="list-style-type: none"> In battery allowed discharging period, and there is no sufficient PV input voltage and the power of load is lower than 100W. This state lasts 5 minutes, the inverter will enter Standby state. In battery charging period, and there is no sufficient PV input voltage and the battery SOC is larger than min SOC. This state lasts 10 minutes, the inverter will enter Standby state. In this state, it detects PV connection, load power, etc to determine whether to exit Standby state and enter Normal state.

2.7 Working mode

Six working modes are available for you to choose in on-grid status, i.e Self use, Feed-in priority, Backup, Peak shaving, TOU and Manual. You can choose the working modes according to your lifestyle and environment.

When the power supply from the electric power company is stopped due to a power outage, it automatically switches to EPS (Off-grid) mode and connects to the distribution board for a specific load, thereby providing power to important electrical appliances.

For how to set the working mode, please refer to the section "10.7.1 User Setting".

2.7.1 Self Use Mode (Priority: Loads > Battery > Grid)

The self use mode is suitable for areas with low feed-in subsidies and high electricity prices. The power of PV will supply the loads first, and the surplus power will charge the battery, then the remaining power will feed into the grid.

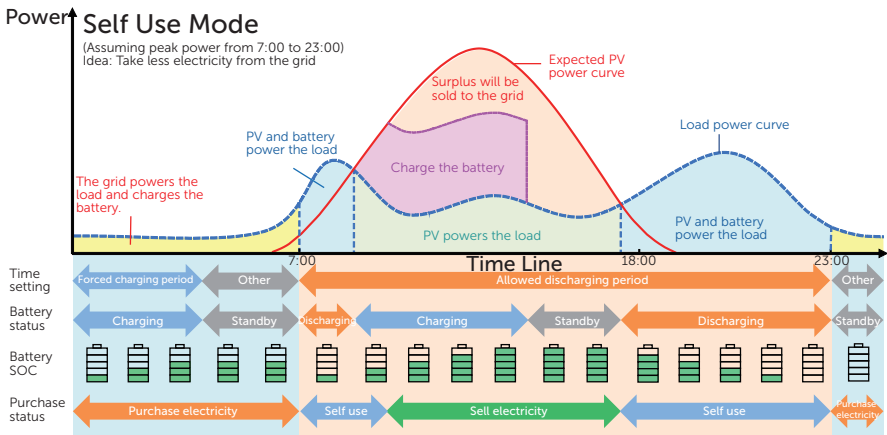

Figure 2-10 Self Use mode

Table 2-4 Description of self use mode

Time period	Inverter working status
Forced charging period	<ul style="list-style-type: none"> Charge the battery first until the battery SOC reaches the specified Charge battery to value. You can configure the inverter to either draw power from the grid or not.

Time period	Inverter working status
Allowed discharging period	PV is sufficient (PV → load → battery → grid) <ul style="list-style-type: none">The power generated from PV prioritizes supplying the load. Any excess power is then directed towards charging the battery, and if there is still surplus electricity, it can be sold to the grid. In the event that the local utility restricts the sale of electricity to the grid, the Export Control value can be set on the inverter. Please refer to "Setting Export Control".
	PV is insufficient (PV+battery → load) <ul style="list-style-type: none">The battery discharges power to the load, and once its capacity reaches Min SOC, it automatically ceases discharging.

Note:

Charge battery to: The battery SOC charged from grid. 30% by default, the settable range is 10%~100%.

Min SOC: Minimum SOC of the battery under grid connection. 10% by default, the settable range is 10%~100%.

Export Control: The power exported to the grid. 60000 W by default, the settable range is 0W~60000W.

Charge & Discharge Period

You can set two configurable working periods: forced charging period and allowed discharging period. The interval not in the charging & discharging period belongs to other time periods.

- Forced charging period (Default period: 00:00~00:00, closed by default)

In the forced charging period, the inverter will charge the battery first until the battery SOC reaches the specified **Charge battery to** value set in each working mode. You have the option to configure the inverter to either draw power from the grid or not.

- Allowed discharging period (Default period: 00:00~23:59)

In the allowed discharging period, the inverter will allow the battery to discharge and charge power in accordance with the working mode and load conditions.

- Period not set as forced charging or allowed discharging period

In this period, the inverter will allow the battery to charge but can not discharge power.

NOTICE!

- The charging and discharging period is only applicable for self-use mode, feed-in priority and backup mode. The priority of forced charging period is higher than all working modes.

2.7.2 Feed-in Priority (Priority: Loads > Grid > Battery)

The feed-in priority mode is suitable for areas with high feed-in subsidies. The power generated from PV is directed towards supplying the loads. Any excess power beyond the load requirements will be fed into the grid.

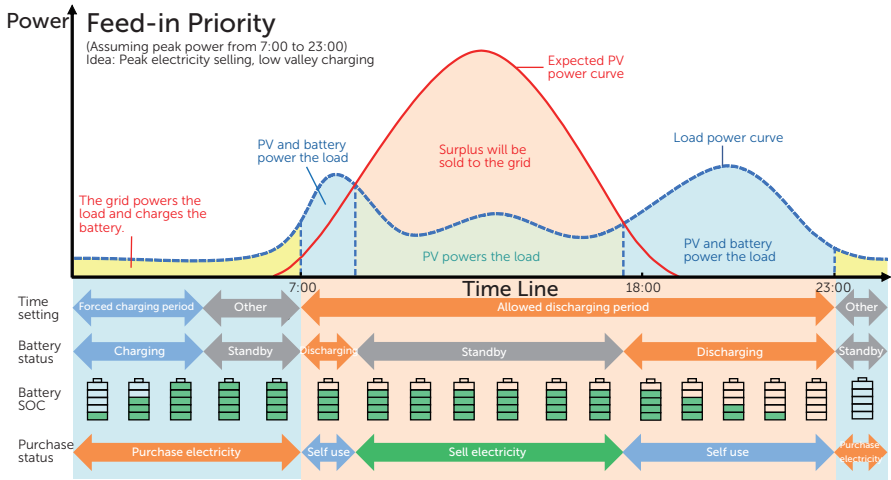

Figure 2-11 Feed-in priority

Table 2-5 Description of feed-in priority

Time period	Inverter working status
Forced charging period	<ul style="list-style-type: none"> Charge the battery first until the battery SOC reaches the specified Charge battery to value. You can configure the inverter to either draw power from the grid or not.
Allowed discharging period	PV is sufficient (PV → load → grid) <ul style="list-style-type: none"> The power generated from PV is directed towards supplying the loads. Any excess power beyond the load requirements will be fed into the grid.
	PV is insufficient (PV+battery → load) <ul style="list-style-type: none"> PV and battery supply power to the load at the same time, and once the battery capacity reaches Min SOC, it automatically ceases discharging.

Note:

Charge battery to: The battery SOC charged from grid. 100% by default, the settable range is 10%~100%.

Min SOC: Minimum SOC of the battery under grid connection. 10% by default, the settable

range is 10%~100%.

NOTICE!

- You can set two configurable working periods: forced charging period and allowed discharging period. Please refer to "Charge & Discharge Period" for details.
- In feed-in priority mode, considering whether the battery can be charged during the daytime. If not, it is recommended to set forced charging period during off-peak hours.

2.7.3 Backup Mode (Priority: Loads > Battery > Grid)

The backup mode is suitable for areas with frequent power outages.

This mode will maintain the battery capacity at relatively high level to ensure that the emergency loads can be used when the grid is off. Same working logic with self-use mode.

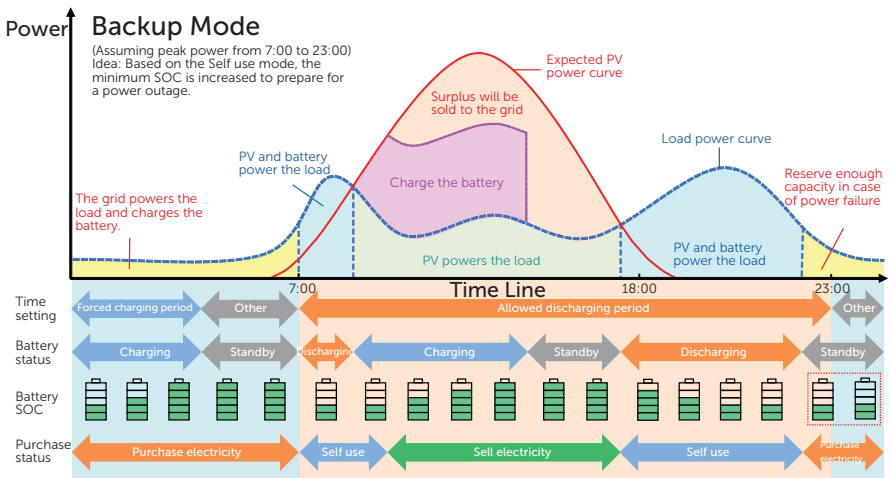

Figure 2-12 Backup mode

Table 2-6 Description of backup mode

Time period	Inverter working status
Forced charging period	<ul style="list-style-type: none"> • Charge the battery first until the battery SOC reaches the specified Charge battery to value. You can configure the inverter to either draw power from the grid or not.

Time period	Inverter working status
Allowed discharging period	<p>The working logic remains the same as for self-use mode. The difference lies in:</p> <ul style="list-style-type: none"> In self-use mode, the battery goes into hibernation when PV input is not available and the battery SOC reaches Min SOC (on-grid min SOC). In the event of a grid outage, the inverter will not enter EPS (Off-grid) mode. In backup mode, the inverter enters a standby state when PV input is not available and the battery SOC reaches Min SOC (on-grid min SOC). In the event of a grid outage, it will switch to EPS (Off-grid) mode until the battery discharges to Min SOC (Off-grid min SOC).

Note:

Min SOC : Minimum SOC 30% by default, the settable range is 30%~100%.

NOTICE!

- You can set two configurable working periods: forced charging period and allowed discharging period. Please refer to "[Charge & Discharge Period](#)" for details.
- If there is a foreseeable power outage, switch from other working modes to the backup mode in advance.

2.7.4 Peak Shaving Mode

Peak shaving mode is set for leveling out peaks in electricity use. The system is intelligently controlled to ensure charging takes place during off-peak hours and discharging occurs during peak hours.

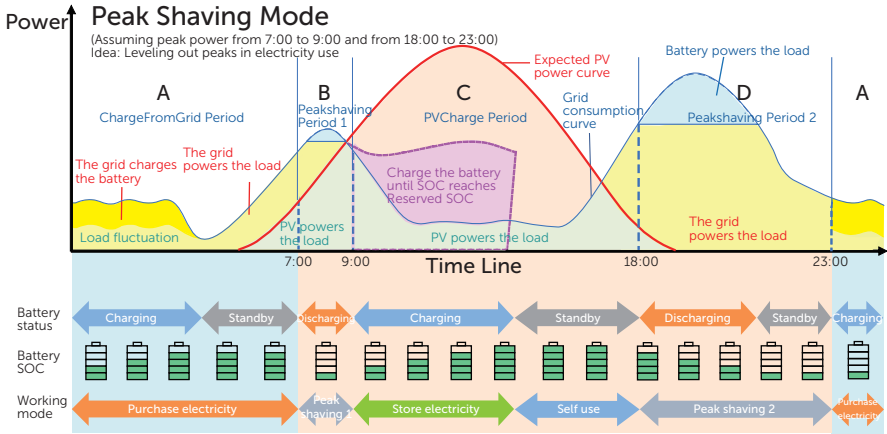

Figure 2-13 Peakshaving mode

Table 2-7 Description of peakshaving mode

Time Period	Inverter working status
Period A	<ul style="list-style-type: none"> The grid can charge the battery to MaxSOC within the set ChargePowerLimits. In this period, the battery will not discharge power.
Period B & D	<p>Grid consumption power < PeakLimits (PV+grid → load)</p> <ul style="list-style-type: none"> The PV and grid will power the load. The battery will not charge or discharge power.
Period C	<p>Grid consumption power > PeakLimits (PV + battery+grid → load)</p> <ul style="list-style-type: none"> The battery will discharge energy for loads and thus reduce the amount of energy purchased from the grid. <p>(PV → battery → load → grid)</p> <ul style="list-style-type: none"> The battery does not discharge power. The PV charges the battery up to the Reserved SOC before supplying power to the loads. Any excess power beyond the load requirements is fed into the grid.

Note:

MaxSOC: The energy taken from grid to charge the battery. 50% by default, the settable range is 10%-100%.

ChargePowerLimits: The charging power from grid. 1000 W by default, the settable range is 0-8000 W.

PeakLimits: The load consumption power from grid side. 0 W by default, the settable range: 0-60000 W.

Reserved SOC: The lower limit of battery SOC required for later peak shaving period. 50% by default, the settable range is 10~100%.

2.7.5 TOU Mode

TOU mode

In the TOU mode, different working modes, i.e Self Use, Charging, Discharging, Peaking shaving and Battery off can be set for different time periods in accordance with actual needs and environment conditions through SolaX Cloud App or Web.

The day can be divided into up to 10 time slots, and the minimum time slot is 15 minutes, independent working mode can be set for each time slot. Please refer to Web Guide or App Guide for details about how to set the TOU mode.

Time Slot	Working Mode
X:XX~X:XX (e.g 0:00~0:15)	Choose one mode from Self Use / Charging / Discharging / Battery off / Peaking shaving

Note:

Self Use: Same working logic with "Self Use Mode", but it is not limited by the charging and discharging time slots. The priority of PV: Loads > Battery > Grid.

Charging: The power of PV will charge the battery as much as possible to the set SOC of **Charge BAT to (%)**. You can set whether to Charge from grid. The default value of **Charge BAT to (%)** is 100%. When the battery reaches the set SOC, the surplus power will perform "Self Use Mode" or supply to the grid (based on the system setup), at this point, Charge from grid is not allowed.

Discharging: If allowed by the battery, the system outputs a specified power from the grid based on the set output percentage, controlling the power at the AC port. You need to set the **Rate of AC Power (%)** through Web or App when choosing Discharging mode. When the battery **Discharge to (%)** reaches the set SOC, the inverter performs "Self-use Mode".

Peak shaving: The working logic is that when the power consumption from the grid exceeds the set PeakLimit value, the battery is allowed to discharge power. The excess power beyond the limit is provided by the combination of photovoltaic and battery to ensure that the maximum power purchased from the grid does not exceed the set limit. You need to set the PeakLimit value through Web or App when choosing Peak shaving mode.

Battery off: The battery neither charges nor discharges. The power of PV will supply to loads or the grid. Only when the battery SOC is lower than the system (TOU) Min SOC, the battery can be charged.

2.7.6 EPS (Off-grid) Mode (Priority: Loads > Battery)

During a power failure, the system will provide uninterrupted power supply to the EPS loads using the power from PV and the battery. It is important to ensure that the EPS loads should not exceed the maximum output power of the battery.

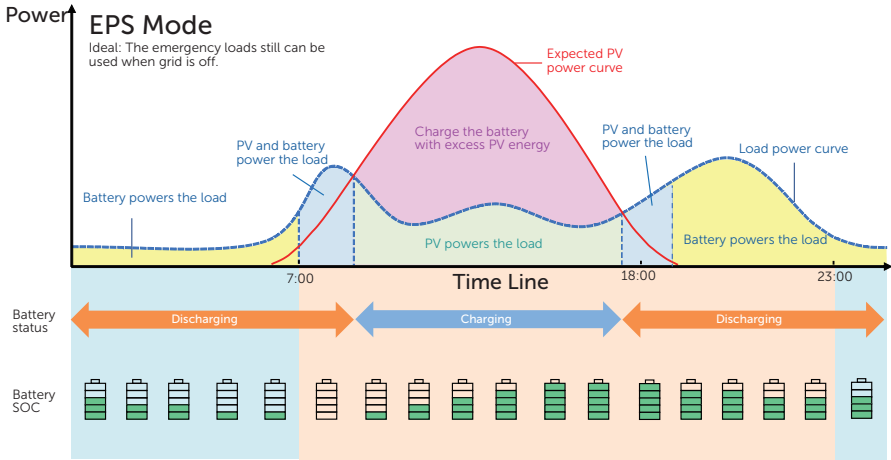

Figure 2-14 EPS (Off-grid) mode

Table 2-8 Description of EPS (Off-grid) mode

Battery SOC	Inverter working status
Battery SOC > Min SOC (off-grid min SOC)	<p>PV is sufficient (PV → load → battery)</p> <ul style="list-style-type: none"> The PV prioritizes supplying power to the load, with any excess energy being directed towards charging the battery.
Battery SOC ≤ Min SOC (off-grid min SOC)	<p>PV is insufficient (PV+battery → load)</p> <ul style="list-style-type: none"> The PV prioritizes supplying power to the load. If the energy is not enough, the battery will discharge power until the battery SOC reaches Min SOC and then error of BatPowerLow will be reported. <p>The inverter reports BatPowerLow. When there is PV, it will charge the battery first. After charging to the set Min ESC SOC value, it will be automatically recovered and enter EPS (Off-grid) mode again.</p>

Note:

Min SOC: Minimum SOC of the battery under off-grid conditions. 10% by default, the settable range: 10%-100%.

Min ESC SOC: The minimum SOC required for re-entry EPS (Off-grid) mode. 30% by default, the settable range: 15%-100%.

2.7.7 Manual Mode

This working mode is only for the qualified personnel to perform debugging and maintenance. It includes **Forced Discharge**, **Forced Charge** and **Stop Chg&Dischrg**. The system will restore to the original working mode after six hours **Manual** mode is set.

3 System Overview

System Overview

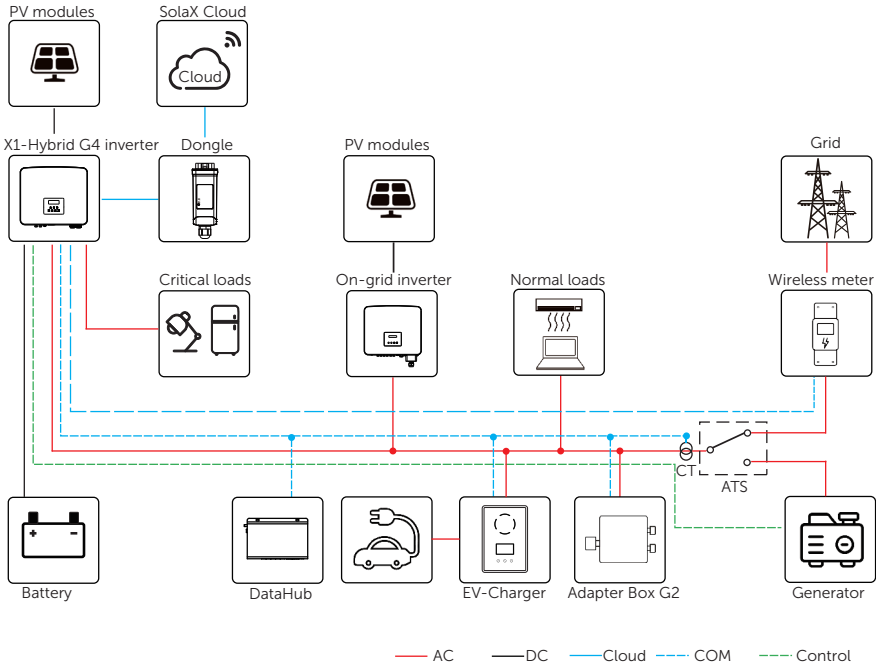

Figure 3-1 System diagram

NOTICE!

- The system diagram is for illustration only , please be subject to the actual situation.

Table 3-1 System item description

Item	Description
X1-Hybrid G4 series (the device covered in this manual)	The X1-Hybrid G4 series is an energy storage inverter that supports grid connection of a photovoltaic system.
PV modules	PV modules work in MPPT mode. The maximum number of MPPT is two.
Battery	The series inverter should be coupled with lithium-ion battery or lead acid battery. It communicates with the inverter via BMS and must comply with the specifications of the regulations.
Meter/CT	The meter/CT is used by the inverter for import / export or consumption readings, and manages the battery charge / discharge accordingly for smart energy management applications. Wireless meter solution is supported.
Additional on-grid inverter (supported)	The series inverter supports micro-grid function that makes hybrid inverter simulate the grid to active on-grid inverter during off-grid period by connecting on-grid inverter to hybrid inverter's EPS (Off-grid) terminal. Please refer to " 15.5 Application of Micro-grid " for specific wiring and setting.
Adapter Box (supported)	With SolaX Adapter Box, you can connect the smart heat pump to the energy storage systems, realizing the control of the heat pump through inverter. Please refer to " 15.2 Application of Adapter Box G2 " for specific wiring and setting.
DataHub (supported)	SolaX DataHub is a professional device that for monitoring platforms of photovoltaic power generation systems, which enables data collection, storage, output control, centralized monitoring, and centralized maintenance of devices such as inverters, electricity meters, and environmental monitoring instruments in photovoltaic power generation systems. Please refer to " 15.4 Application of DataHub " for specific wiring and setting.
EV-Charger (supported)	The series inverter can communicate with SolaX EV-Charger to form an intelligent photovoltaic, storage and EV charging energy system, thus maximizing the utilization of photovoltaic energy. Please refer to " 15.3 Application of EV-Charger " for specific wiring and setting.
Generator (supported)	SolaX PV-Genset solution ensures optimum interaction between the photovoltaics and diesel generator, which saves fuel, lowers energy costs and ensures a stable and reliable power supply. Please refer to " 15.1 Application of Generator " for specific wiring and setting.

System Overview

Item	Description
Grid	220 V / 230 V and 240 V grid are supported.
SolaX Cloud	SolaX Cloud is an intelligent, multifunctional monitoring platform that can be accessed either remotely or through a hard wired connection. With the SolaX Cloud, the operators and installers can always view key and up to date data.

4 Transportation and Storage

If the inverter is not put into use immediately, the transportation and storage requirements need to be met:

Transportation

- Observe the caution signs on the packaging of inverter before transportation.
- Pay attention to the weight of the inverter. Carry the inverters by the required number of personnel as specified by local regulations.(gross weight of X1-Hybrid G4: 28 kg for 3.0~6.0kW, 29kg for 7.5kW)
- Wear protective gloves when carrying the equipment by hand to prevent injuries.
- When lifting up the inverter, hold the handle position and the bottom position of the carton. Keep the inverter horizontal in case of falling down.

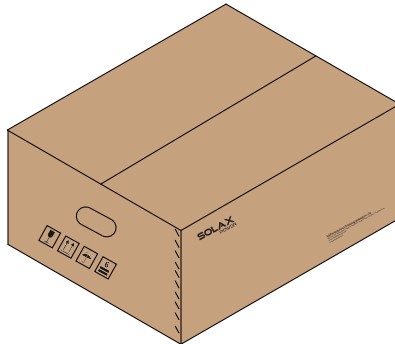

Figure 4-1 Caution signs on the packaging

Storage

- The inverter must be stored indoors.
- Do not remove the original packaging material and check the outer packaging material regularly.
- The storage temperature should be between -40°C and $+65^{\circ}\text{C}$. The relative humidity should be between 4%RH and 100%RH.
- Stack the inverter in accordance with the caution signs on the inverter carton to prevent their falling down and device damage. Do not place it upside down.

5 Preparation before Installation

5.1 Selection of Installation Location

The installation location selected for the inverter is quite critical in the aspect of the guarantee of machine safety, service life and performance. It has the IP65 ingress protection, which allows it to be installed outdoor. The installation position shall be convenient for wiring connection, operation and maintenance.

5.1.1 Environment Requirement

Make sure the installation environment meets the following conditions:

- The ambient temperature: -35°C to $+60^{\circ}\text{C}$.
- The relative humidity shall be between 4-100%RH.
- Do not install the inverter in the areas where the altitude exceeds 3000 m.
- Install the inverter in a well-ventilated environment for heat dissipation. It is recommended to install an awning over the inverter if it is installed on a support outdoor.
- Do not install the inverter in areas with flammable, explosive and corrosive materials or near antennas.
- Avoid direct sunlight, rain exposure and snow accumulation.

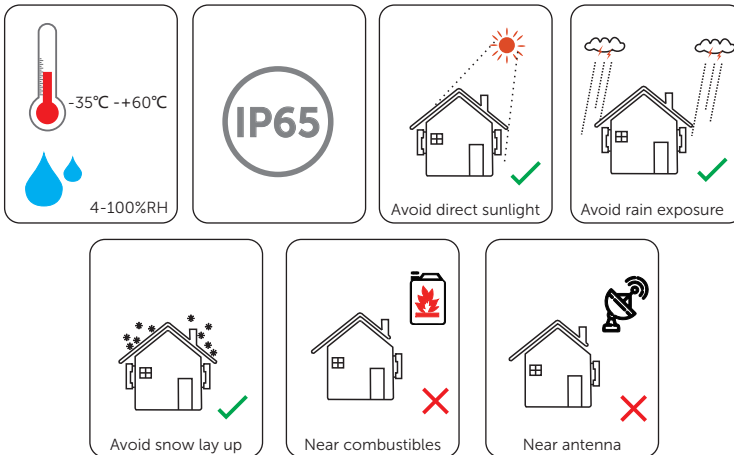

NOTICE!

- For outdoor installation, precautions against direct sunlight, rain exposure and snow accumulation are recommended.
- Exposure to direct sunlight raises the temperature inside the device. This temperature rise poses no safety risks, but may impact the device performance.
- Install the inverter at least 500 meters away from the coast and avoid sea breeze directly hit.

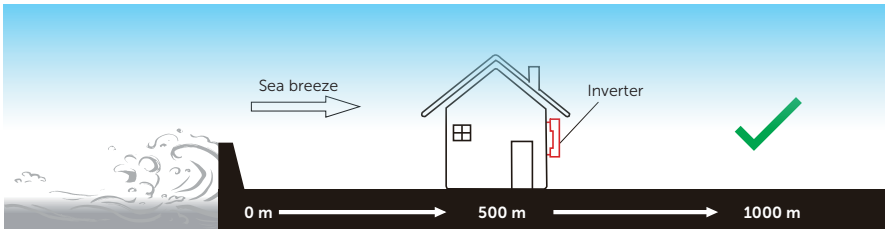

Figure 5-1 Recommended installation position

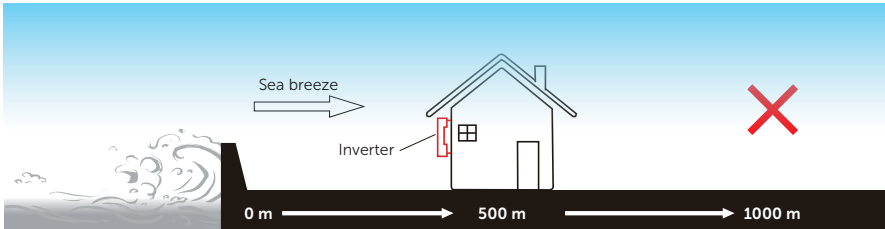

Figure 5-2 Incorrect installation position

NOTICE!

- For the installation of the whole system, please refer to the specific environment requirement of each unit.

5.1.2 Installation Carrier Requirement

The installation carrier must be made of a non-flammable material, such as solid brick, concrete, etc. and be capable of supporting the weight of the inverter and suitable of the dimensions of the inverter. If the wall strength is not enough (such as wooden wall, the wall covered by a thick layer of decoration), it must be strengthened additionally.

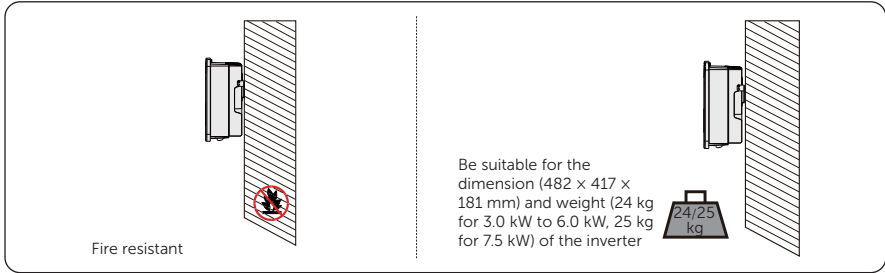

Figure 5-3 Installation carrier requirement

NOTICE!

- Please take the weight of battery into account when wall-mounting the whole system.

5.1.3 Clearance Requirement

The minimum clearance reserved for the connected terminal at the bottom of inverter should be 13 cm. When planning installation space, it is important to consider the bending radius of the wires.

To guarantee proper heat dissipation and ease of disassembly, the minimum space around the inverter must meet the standards indicated below.

For installations with multiple inverters, make sure to leave a minimum space of 30 cm between each inverter. In areas with high ambient temperatures, increase the clearances between the inverters and provide adequate fresh air ventilation if feasible.

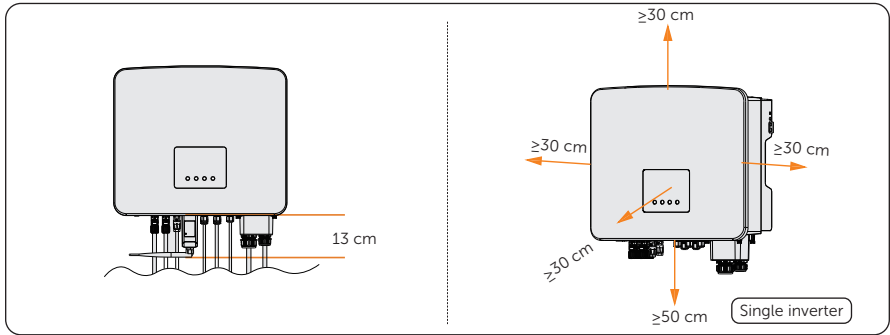

Figure 5-4 Clearance requirement for single inverter

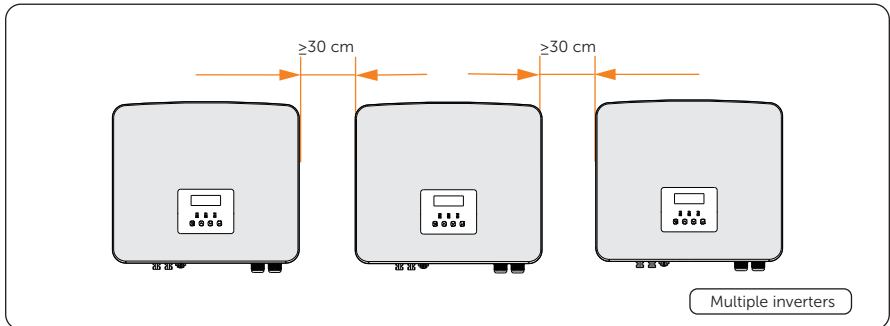

Figure 5-5 Clearance requirement for multiple inverters

5.2 Tools Requirement

Installation tools include but are not limited to the following recommended ones. If necessary, use other auxiliary tools on site. Please note that the tools used must comply with local regulations.

 <p>Hammer drill (drill bit: Ø10 mm)</p>	 <p>Multimeter (> 600 VDC)</p>	 <p>Measuring tape</p>	 <p>Utility knife</p>
 <p>Marker</p>	 <p>Torque screwdriver (Flat head: including SL5) (Phillips head: including PH1, PH2)</p>	 <p>Allen key (including H4)</p>	 <p>Wire stripper</p>
 <p>Crimping tool for RJ45</p>	 <p>Crimping tool</p>	 <p>Crimping tool for PV terminal</p>	 <p>Torque wrench (including 10 mm wrench)</p>
 <p>Rubber mallet</p>	 <p>Crimping tool for ferrule</p>	 <p>Diagonal plier</p>	 <p>Spirit level</p>
 <p>Heat gun</p>	 <p>Heat shrink tubing (Ø6 mm)</p>	 <p>Wire cutter</p>	 <p>Anti-dust mask</p>
 <p>Safety gloves</p>	 <p>Safety boots</p>	 <p>Safety goggles</p>	

5.3 Additionally Required Materials

Table 5-1 Additionally required wires



No.	Required Material	Type	Conductor Cross-section
1	PV wire	 Dedicated PV wire with a voltage rating of 600 V	4 mm ²
2	Communication wire	 Network cable CAT5E	0.2 mm ²
3	Additional PE wire	 Conventional yellow and green wire	4 mm ²

Table 5-2 Cable and circuit breaker recommended for Grid connection



Model	3.0-D	3.7-D	5.0-D	6.0-D	7.5-D
Three-core copper wire 	4-6 mm ²	6-8 mm ²	8-10 mm ²	8-10 mm ²	8-10 mm ²
Circuit breaker 	32 A	40 A	50 A	50 A	50 A

Table 5-3 Cable and circuit breaker recommended for Grid connection





Model	3.0-M	3.7-M	5.0-M	6.0-M	7.5-M
Three-core copper wire 	3-4 mm ²	3-4 mm ²	4-6 mm ²	4-6 mm ²	6-8 mm ²
Circuit breaker 	25 A	25 A	32 A	32 A	40 A

Table 5-4 Cable and Micro-breaker recommended for EPS (Off-grid) connection

Model	3.0-D/M	3.7-D/M	5.0-D/M	6.0-D/M	7.5-D/M
Two-core copper wire 	3-4 mm ²	3-4 mm ²	4-6 mm ²	4-6 mm ²	6-8 mm ²
Circuit breaker 	25 A	25 A	32 A	32 A	40 A

6 Unpacking and Inspection

6.1 Unpacking

- The inverter undergoes 100% testing and inspection before delivery. However, damages may still occur during transportation. Before unpacking, please carefully check the external packaging for any signs of damage, such as punctures or cracks.
- Unpacking the inverter according to the following figure.

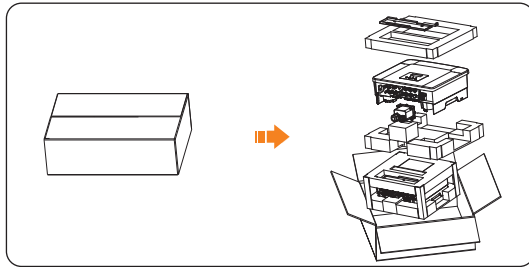

Figure 6-1 Unpacking the inverter

- Properly handle all the packaging materials in case they may be reused for storage and transportation of the inverter in the future.
- Upon opening the package, check whether the inverter is intact and whether all accessories are included. If any damage is found or any parts are missing, contact your dealer immediately.

6.2 Scope of Delivery



Table 6-1 Packing list

M series

Item	Description	Quantity	Remark
/	Inverter	1 pc	
/	Bracket	1 pc	
A	Self-tapping screw	3 pcs	For wall-mounting bracket installation
B	Expansion tube	3 pcs	
C	Washer	3 pcs	
D	M5 inner hexagon bolt	1 pc	For securing inverter on the wall-mounting bracket

Unpacking and Inspection

Item	Description	Quantity	Remark
E	Waterproof connector with RJ45	3 pcs for Australia 2 pcs for other countries	
F	Document	/	
S	Positive PV dustproof buckle	2 pc	
T	Negative PV dustproof buckle	2 pc	
/	Disassembling tool for PV terminal	1 pc	
/	Meter (optional)	1 pc	
/	Dongle	1 pc	

D series

Item	Description	Quantity	Remark
/	Inverter	1 pc	
/	Bracket	1 pc	
A	Self-tapping screw	3 pcs	
B	Expansion tube	3 pcs	For wall-mounting bracket installation
C	Washer	3 pcs	
D	M5 inner hexagon bolt	1 pc	For securing inverter on the wall-mounting bracket
E	Waterproof connector with RJ45	4 pcs for Australia 3 pcs for other countries	
F	Document	/	
G	Negative PV connector	2 pcs	
H	Negative PV pin contact	2 pcs	
I	Positive PV connector	2 pcs	
J	Positive PV pin contact	2 pcs	
K	Negative Battery connector	1 pc	
L	Positive Battery connector	1 pc	
M	8 mm ² Ferrule	3 pcs	For GRID connection
N	6 mm ² Ferrule	2 pcs	For EPS (Off-grid) connection
O	OT terminal	1 pcw	For grounding
P	RJ45 connector	1 pc	
Q	RJ45 terminal	1 pc	
R	CT (optional)	1 pc	
S	Positive PV dustproof buckle	2 pc	
T	Negative PV dustproof buckle	2 pc	
/	Disassembling tool for PV terminal	1 pc	

/	AC protective cover	1 pc
/	Meter (optional)	1 pc
/	Dongle	1 pc

NOTICE!

- Refer to the actual delivery for the optional accessories.

7 Mechanical Installation

! WARNING!

- Only qualified personnel are allowed to perform the mechanical installation in accordance with local laws and regulations.
- Check the existing power cables or other piping in the wall to prevent electric shock or other damage.
- Use insulated tools and wear personal protective equipment throughout the installation and maintenance process.

! CAUTION!

- During installation, always be cautious about the weight of the inverter. Improper lifting or dropping of the inverter may result in personal injury.

NOTICE!

- Install the inverter at a maximum back tilt of 5 degrees and avoid it being forward tilted, side tilted, or upside down.

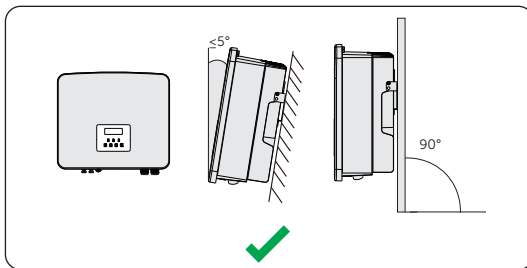

Figure 7-1 Correct installation

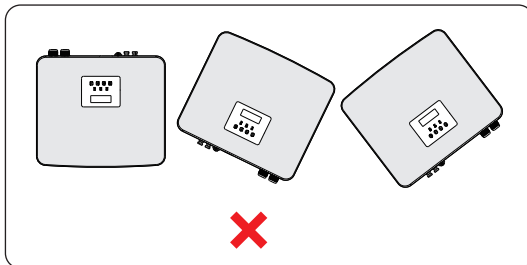

Figure 7-2 Incorrect installation

7.1 Dimensions for mounting

Before installation, check the dimensions of the wall mounting bracket and ensure that enough space is reserved for the installation and heat dissipation of the entire system.

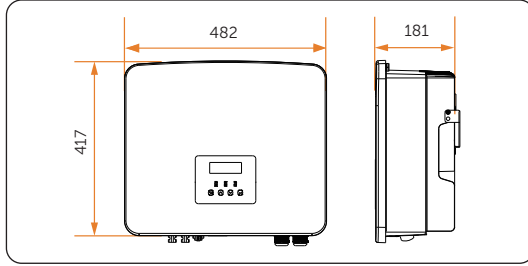

Figure 7-3 Dimensions 1 (Unit: mm)

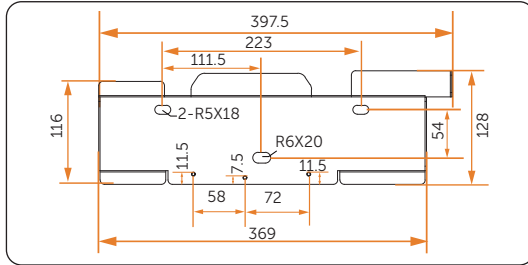

Figure 7-4 Dimensions 2 (Unit: mm)

7.2 Installation procedures

Step 1: Horizontally align the wall mounting bracket with the wall, adjust the position of the bracket with a spirit level until the bubble stays in the middle, and then mark holes. Please note that take the height of the battery into account when determining the position of the wall mounting bracket. When Matebox is needed to install, please refer to the *Quick Installation Guide* of the Matebox to install the inverter and the Matebox.

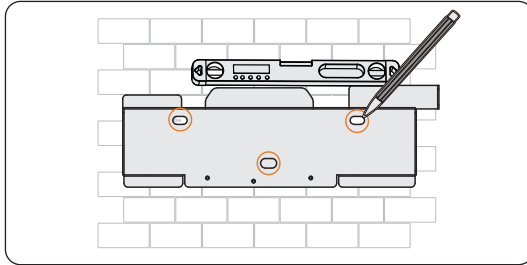

Figure 7-5 Marking the holes

Step 2: Set the wall mounting bracket aside and drill holes with $\text{Ø}10$ drill bit. The depth of the holes should be over 80 mm.

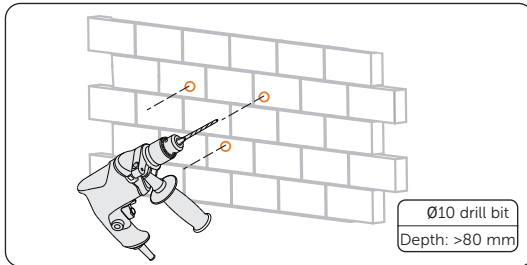

Figure 7-6 Drilling holes

Step 3: Insert expansion tubes (Part B) into the holes, use rubber hammer to knock the expansion tubes into the wall.

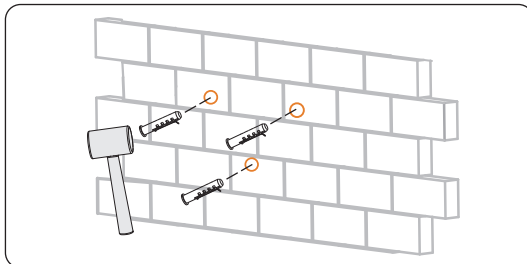

Figure 7-7 Knocking the expansion tubes

Step 4: Attach the wall mounting bracket on the wall again. Knock the self-tapping screws (Part A) with washer (Part C) into the holes and secure them to the wall by torque wrench.

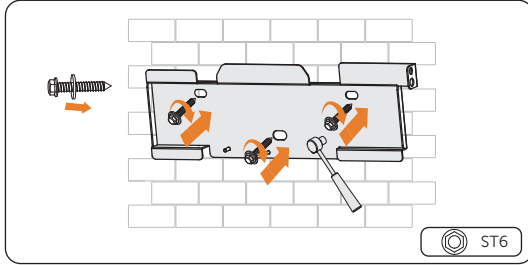

Figure 7-8 Securing the wall mounting bracket

Step 5: Lift up the inverter collaboratively by the required number of personnel in accordance with the local regulation and hang it onto the wall mounting bracket. Make sure that the hanging holes of the inverter are properly inserted into the lugs of the bracket.

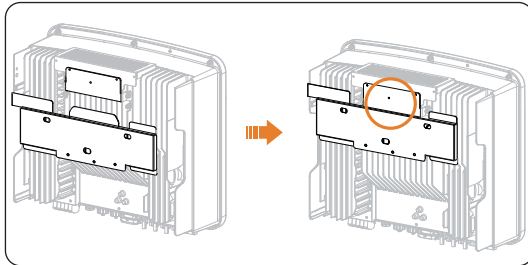

Figure 7-9 Hanging the inverter

Step 6: Use M5 screws (Part D) to secure the inverter on both sides.

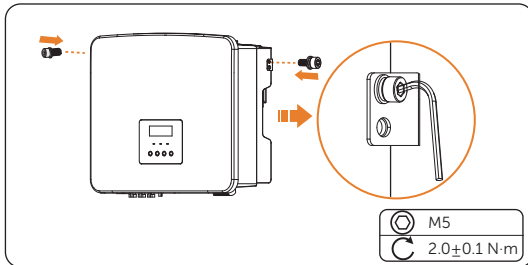

Figure 7-10 Securing the inverter

Step 7: (Optional) For safety reason, install an anti-theft lock. The anti-theft lock is not in the scope of delivery. If necessary, prepare a lock with a diameter less than $\varnothing 10$ mm by yourself, and keep the key to the lock in a safe place.

8 Electrical Connection

 DANGER!

- Before electrical connection, make sure the DC switch and AC breaker are disconnected. Otherwise, the high voltage may cause electric shock, resulting in severe personal injuries or even death.

 WARNING!

- Only qualified personnel are allowed to perform the electrical connection following local laws and regulations.
- Strictly follow the instructions of this manual or other related documentation for electrical connection. Inverter damages caused by incorrect wiring are not covered by the warranty.
- Use insulated tools and wear personal protective equipment throughout the electrical connection process.

8.1 Overview of Electrical Connection

8.1.1 Terminals of Inverter

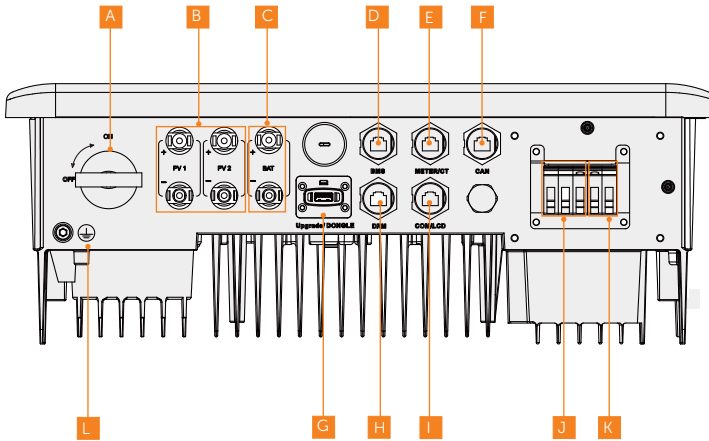

Figure 8-1 Terminals of Inverter

Table 8-1 Description of terminals

Item	Description	Remarks
A	DC switch	
B	PV connection terminal	
C	Battery connection terminal	
D	BMS terminal	For battery communication connection
E	Meter/CT terminal	
F	CAN terminal	For Parallel connection
G	Dongle terminal	
H	DRM terminal	
I	COM/LCD terminal	For communication with SolaX's internal devices
J	Grid connection terminal	
K	EPS (Off-grid) connection terminal	
L	Ground connection point	

8.1.2 Cable Connections of Inverter

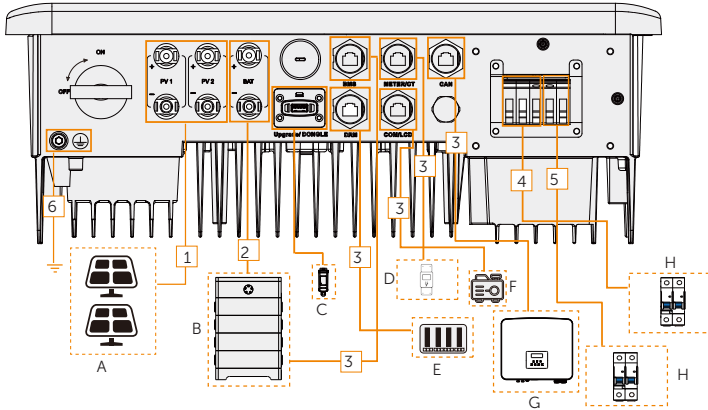

Figure 8-2 Cable connections of inverter

Table 8-2 Descriptions of connected part

Item	Part	Description	Source
A	PV module	A PV string is composed of the PV modules connected in series.	Prepared by user
B	Battery	T-BAT H 5.8/MC0600/T-BMS-MCR0800/T-BMS-MCS0800 etc. can be connected with the series inverter.	Purchased from SolaX
C	Monitoring dongle, and USB for upgrading	Only SolaX monitoring dongle supported.	Purchased from SolaX
D	Meter/CT	CT Supported meter: SolaX authorized DDSU666 and DDSU666-CT.	Purchased from SolaX
E	Power grid scheduling device (only applicable to Australia and New Zealand)	Select the devices that meet the power grid scheduling requirements.	Prepared by user

F	Dry contact controlled device and SolaX communication device	Dry contact controlled device: Generator is supported. For generator, select a generator equipped with an Auto Transformer Switch (ATS), and the rated output power of the generator should be greater than the sum of the load power and the battery charging power. SolaX communication device: SolaX DataHub, Adapter Box G2 and EV-Charger are supported. Select the device as needed.	Purchased from SolaX
G	X1-Hybrid G4 series inverter	Select a same model of inverter	Purchased from SolaX
H	AC switch	Select an appropriate AC switch according to the local regulations to ensure the inverter can be securely disconnected from the grid when an emergency occurs. Refer to " 5.3 Additionally Required Materials " for the recommended specifications of AC switch.	Prepared by user

Table 8-3 Descriptions of cables

Item	Cable	Type and specifications	Source
1	PV DC input power cable	Refer to " 5.3 Additionally Required Materials ".	Prepared by user
2	Battery power cable	/	Delivered with battery
3	Communication cable		Prepared by user
4	Grid cable	Refer to " 5.3 Additionally Required Materials ".	Prepared by user
5	EPS (Off-grid) cable		Prepared by user
6	PE cable		Prepared by user

8.2 PE Connection

The inverter must be reliably grounded. The PE connection point has been marked with



It is recommended to connect the inverter to a nearby grounding point.

PE connection procedures

Step 1: Strip the insulation of the PE cable to an appropriate length.

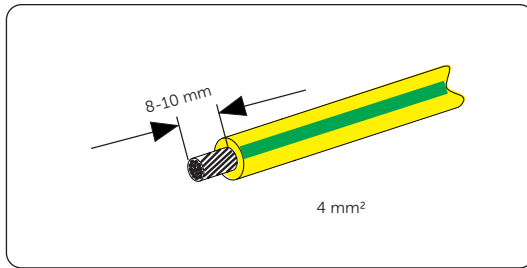

Figure 8-3 Stripping the PE cable

Step 2: Pull the heat-shrink tubing over the PE cable and insert the stripped section into the OT terminal (Part O).

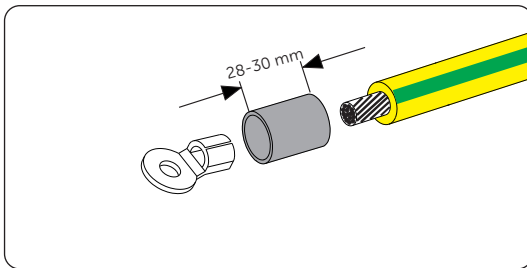

Figure 8-4 Installing the tubing and OT terminal

Step 3: Crimp it with crimping tool, pull the heat-shrink tubing over the stripped section of the OT terminal and use a heat gun to shrink it so that it can be firmly contacted with the terminal.

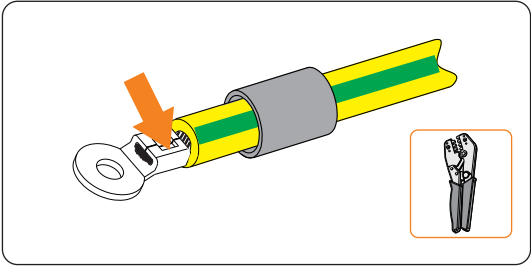

Figure 8-5 Crimping the cable

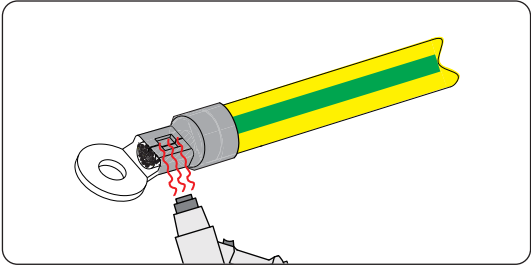

Figure 8-6 Shrinking the tubing

Step 4: Remove the PE screw on the inverter with allen key.

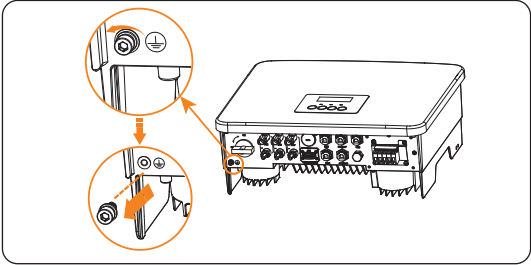

Figure 8-7 Uninstalling the screw

Step 5: Connect the assembled PE cable to the grounding point of the inverter, and secure it with the original screw. (Torque: 2.0 ± 0.2 N·m)

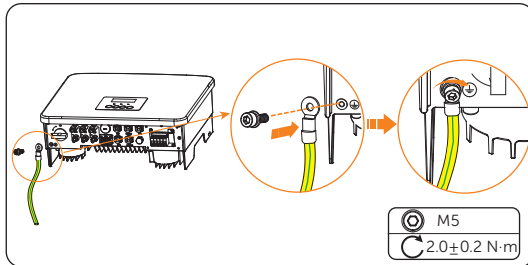

Figure 8-8 Securing the PE cable

8.3 AC Connection

NOTICE!

- Before connecting the inverter to the grid, approval must be received by local utility as required by national and state interconnection regulations.

The inverter supports the EPS (Off-grid) mode. When connected to the grid, the inverter outputs go through the Grid terminal, and when disconnected from the grid, the inverter outputs go through the EPS (Off-grid) terminal.

Requirements for AC connection

- Grid voltage requirement
 - » The grid voltage and frequency must be within the allowable range (220 V / 230 V / 240V, 50 / 60 Hz) and comply with the requirements of the local power grid.
- Residual Current Device (RCD)
 - » The inverter does not require an external RCD when operating. If an external RCD is required by local regulations, a 300 mA Type-A RCD is recommended. If required by local regulations, a Type-B RCD is also permitted.
- AC breaker
 - » An AC breaker that matches the power of the inverter must be used between the inverter output and the power grid. Each inverter must be equipped with an independent breaker or other load disconnection unit to ensure the safe disconnection from the grid. For specific information on the AC breaker for Grid and EPS (Off-grid), see "[5.3 Additionally Required Materials](#)".
- EPS (Off-grid) load
 - » Make sure that the rated power of the EPS (Off-grid) load is within the rated output power range of the inverter. Otherwise, the inverter will report an **EPS Overload Fault** alarm. In this case, turn off some loads to suit the rated EPS (Off-grid) output power range of the inverter. After reporting the fault three times, press the **ESC** key on the LCD screen to clear the fault.
 - » When connecting to the EPS (Off-grid) terminal, pay attention to the following points:

Medical equipment	Connection prohibited
Precision instrument	Connection prohibited
Appliances susceptible to malfunctions in the event of power outages during use.	Connection prohibited

- » For inductive loads such as refrigerators, air conditioner, washing machine, etc., ensure that their start power does not exceed the EPS peak power of the inverter.

Table 8-4 EPS (Off-grid) load information

Type of load	Equipment	Start power
Resistive load	Lamp	Rated power
	Fan	Rated power
	Hair dryer	Rated power
Inductive load	Refrigerator	3-5 times rated power
	Air conditioner	3-6 times rated power
	Washing machine	3-5 times rated power
	Microwave oven	3-5 times rated power

* Refer to the nominal start power of the equipment for the actual start power.

Wiring procedures

Step 1: Prepare a three core cable and a two core cable as the Grid and EPS (Off-grid) cables and strip the insulation of L, N and the grounding conductor to an appropriate length.

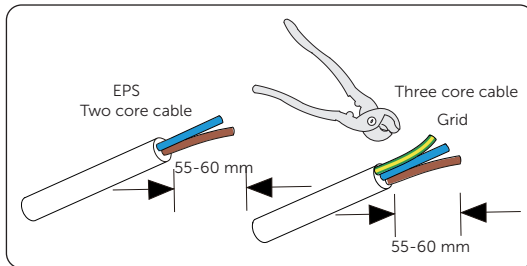

Figure 8-9 Stripping the cables

Step 2: Cut the AC protective cover open as shown below. Thread the Grid and EPS (Off-grid) cable through the AC protective cover.

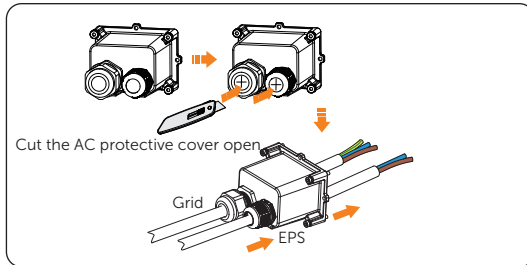

Figure 8-10 Threading the cables

Step 3: Strip the insulation of L, N and the grounding conductor to an appropriate length.

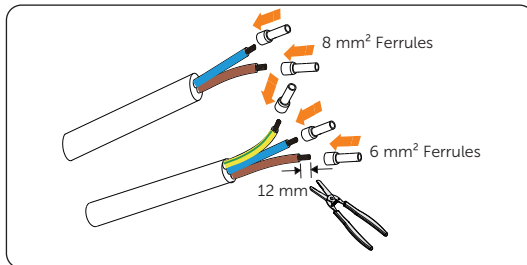

Figure 8-11 Stripping the cables

Step 4: Insert the conductors L, N, and the grounding conductor into the ferrules (Part M&N). Use a crimping tool for ferrules to crimp it. Make sure the conductors are correctly assigned and firmly seated in the ferrules.

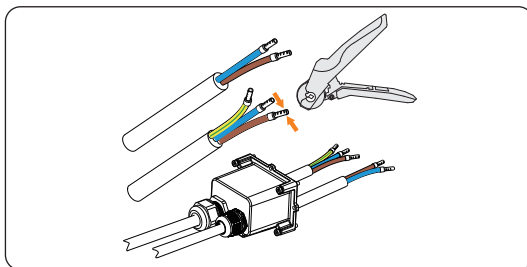

Figure 8-12 Crimping the conductors

Step 5: Remove the cap from the AC terminal.

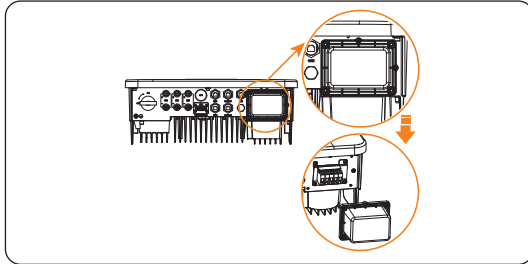

Figure 8-13 Removing the cap of AC terminal

Step 6: Loosen the M5 terminal block screws. Then insert the crimped conductors L, N, and the grounding conductor into the terminal block and tighten the terminal block screws (torque: 1.5 ± 0.1 N·m).

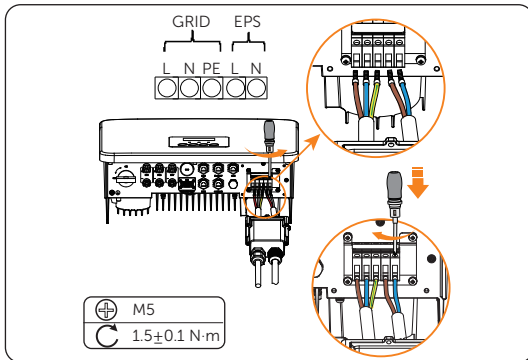

Figure 8-14 Connecting the cables

Step 7: Tighten the screws on the AC terminal, and then tighten the swivel nuts.

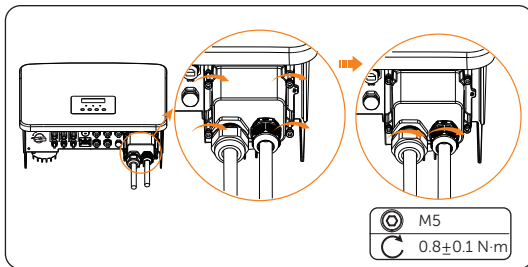

Figure 8-15 Installing the AC protective cover to inverter

 DANGER!

- Before powering on the inverter, make sure the AC connector has been installed correctly on the Grid and EPS (Off-grid) terminal even if the EPS (Off-grid) terminal is not wired. Otherwise, electrical shock may be caused by high voltage, resulting in serious personal injury or death.

 WARNING!

- Reinstall AC terminal caps immediately after removing the connectors from the terminals.

8.4 PV Connection

 DANGER!

- When exposed to the sunlight, PV modules will generate lethal high voltage. Please take precautions.
- Before connecting the PV modules, make sure that both DC switch and AC breaker are disconnected, and that the PV module output is securely isolated from the ground.

 WARNING!

- To mitigate the risk of fire, it is crucial to utilize a dedicated crimping tool specifically designed for PV installations to ensure secure and reliable connections.

 CAUTION!

- Power is fed from more than one source and more than one live circuit.

Requirements for PV connection

- Open circuit voltage and operating voltage
 - » The open circuit voltage of each module array cannot exceed the maximum PV input voltage (600 V) of the inverter. Otherwise, the inverter may be damaged.
 - » The operating voltage of PV modules must be within the MPPT voltage range (70-550 V) of the inverter. When the open circuit voltage exceeds 570V, the inverter will prompt a **PV Volt Fault** alarm. Consider the impact of low temperature on the voltage of the photovoltaic panels, as lower temperatures tend to result in higher voltages.

- PV module
 - » The PV modules within the same MPPT channel are of the same brand. Additionally, the strings within the same channel should have identical quantities, and be aligned and tilted identically.
 - » The positive or negative pole of the PV modules should not be grounded.
 - » The positive cables of the PV modules must be connected with positive DC connectors.
 - » The negative cables of the PV modules must be connected with negative DC connectors.

Wiring procedures

Step 1: Strip the insulation of the PV cables to an appropriate length.

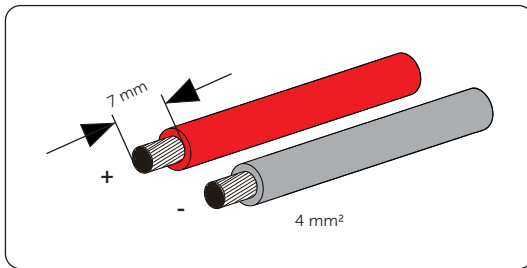

Figure 8-16 Stripping the PV cable

Step 2: Insert the stripped cable into the PV pin contact (Part H&J).

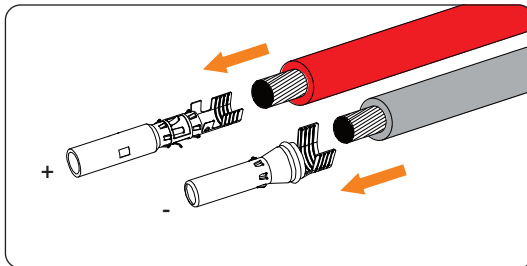

Figure 8-17 Inserting the PV pin contact

Step 3: Make sure the the PV cable and PV pin contact are of the same polarity. Crimp it with crimping tool for PV terminal. Pay attention to the crimping position.

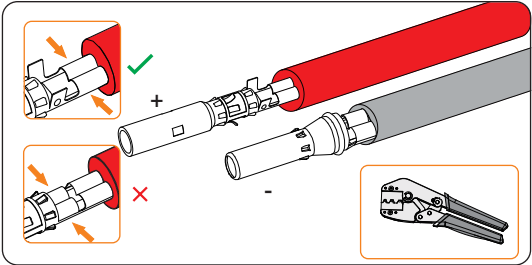

Figure 8-18 Crimping the terminal

Step 4: Thread the PV cable through swivel nut and insert the cable into the PV connector (Part G&I).

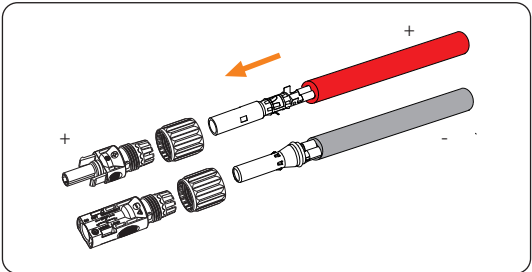

Figure 8-19 Threading the PV cable

Step 5: A "Click" will be heard if it is connected correctly. Gently pull the cable backward to ensure firm connection. Tighten the swivel nut. Verify that the PV connectors have the correct polarity before connection.

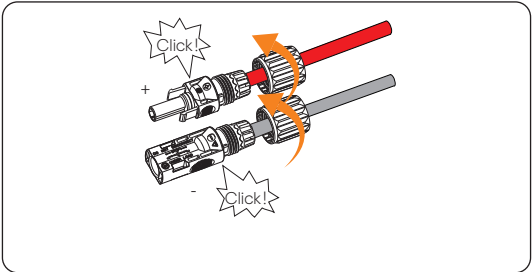

Figure 8-20 Securing the PV cable

Step 6: Use a voltage measuring device which complies with the local regulation to measure the positive and negative voltage of the assembled PV connectors. Make sure the open circuit voltage does not exceed the input limit of 600 V.

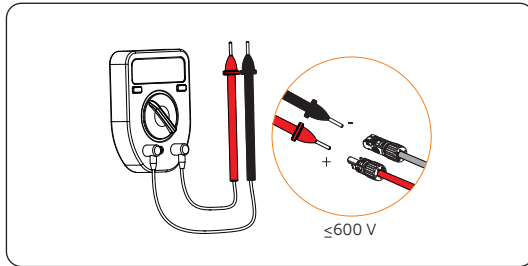

Figure 8-21 Measuring the voltage of PV connectors

NOTICE!

- If the voltage reading is negative, it indicates an incorrect DC input polarity. Please check if the wiring connections on the measuring device are correct or PV connectors are not mistakenly connected.

Step 7: Remove the PV terminal caps and connect the assembled PV connectors to the corresponding terminals until there is an audible "Click". The PV+ on the string side must be connected to the PV+ on the inverter side, and the PV- on the string side must be connected to the PV- on the inverter side.

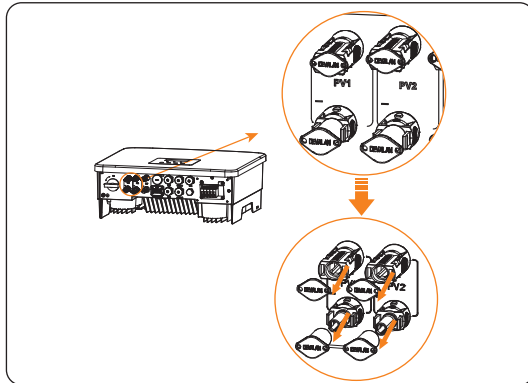

Figure 8-22 Removing the PV terminal caps

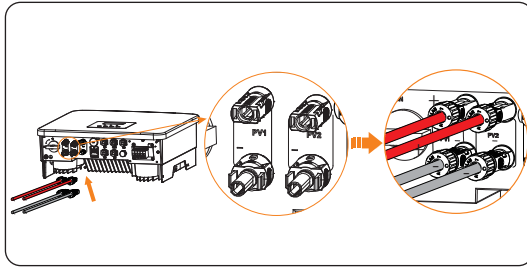

Figure 8-23 Connecting the PV cable

Step 8: Seal the unused PV terminals with the dustproof buckles (Part S&T) in the packing list.

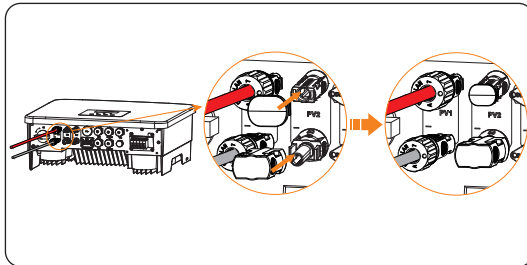



Figure 8-24 Sealing the unused PV terminals

WARNING!

- Seal the unused PV terminals with the dustproof buckles. If all PV terminals are connected, keep the dustproof buckles in a safe place. Reinstall them immediately after removing the connectors from the terminals.

8.5 Battery Power Cable Connection

 **DANGER!**

- Before connecting the cables, make sure the breaker, power button (if any) and DC switch (if any) of battery is OFF.
- Always ensure correct polarity. Never reverse the polarity of the battery cables as this will result in inverter damage.

NOTICE!

- The power cable of battery is in the battery accessory pack. NOT in the scope of inverter's delivery.

Requirments for battery connection

- Battery
 - » SolaX high voltage Lithium-ion battery and Lead-acid battery
 - » The inverter is equipped with one battery terminals. Max charge and discharge current is 30 A.
 - » Make sure the input voltage is higher than minimum voltage 80 V and lower than maximum input voltage 480 V.
- Micro circuit breaker (MCB)
 - » If the battery is integrated with a readily accessible internal DC breaker, no additional DC breaker is required. If local regulations mandate the use of a DC MCB between the battery and the inverter, install a non-polar DC MCB.
 - » The nominal voltage of DC MCB should be larger than maximum voltage of battery.
- Battery configuration information

Battery Control	Battery Modules
T-BAT H 5.8 (1 PC)	HV11550 (0-2 PCS)
MC0600 (1 PC)	HV10230 (1-4 PCS)
TBMS-MCR0800 (1 PC)	TP-HR25 (2~8 PCS)
TBMS-MCR0800 (1 PC)	TP-HR36 (2~8 PCS)
TBMS-MCS0800 (1 PC)	TP-HS25 (2~8 PCS)
TBMS-MCS0800 (1 PC)	TP-HS36 (2~8 PCS)

Wiring procedures

Step 1: Strip the insulation of the battery power cable to an appropriate length.

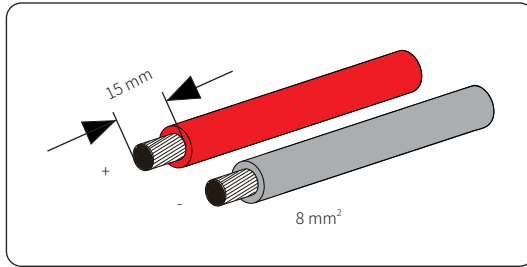

Figure 8-25 Stripping the battery cable

Step 2: Insert the stripped cable into the battery connector (Part K&L).

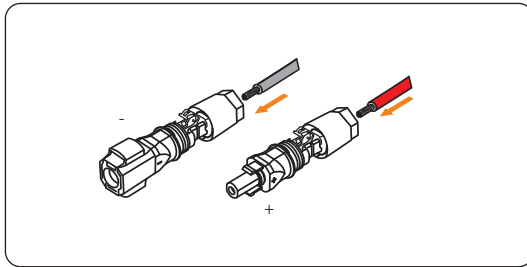

Figure 8-26 Inserting the battery pin contact

Step 3: Insert the spring to the cavity. A "Click" will be heard if it is connected correctly. Then push the ends together. Gently pull the cable backward to ensure firm connection. Tighten the swivel nut.

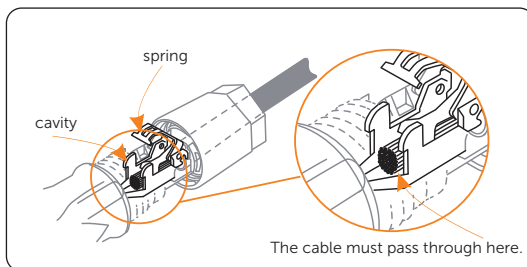

Figure 8-27 Diagram of spring and cavity

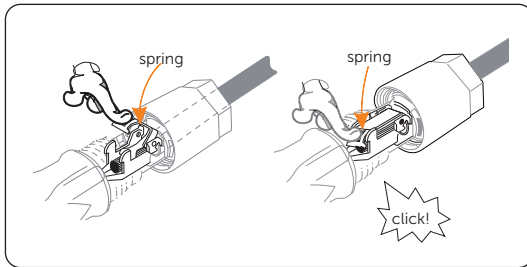

Figure 8-28 Fastening the spring

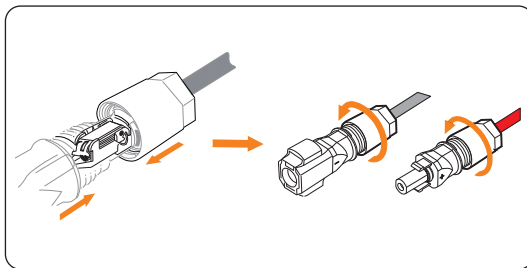

Figure 8-29 Tightening the battery cable

Step 4: Remove the battery terminal caps and connect the assembled battery connectors to corresponding terminals until there is an audible "Click".

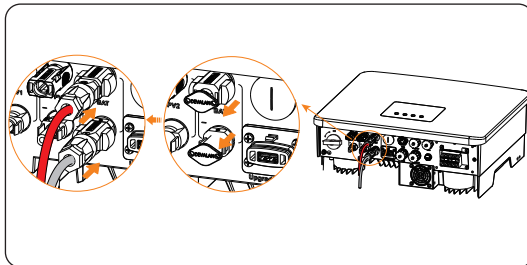

Figure 8-30 Connecting the battery connector

 **WARNING!**

- Keep the terminal caps in a safe place if batteries are connected to the inverter. Reinstall the caps immediately after removing the connectors from the terminals.

8.6 COM Communication Connection (Meter/CT)

The COM terminal is used for Meter/CT connection via Meter/CT terminal.

8.6.1 Pin assignment of Meter/CT terminal

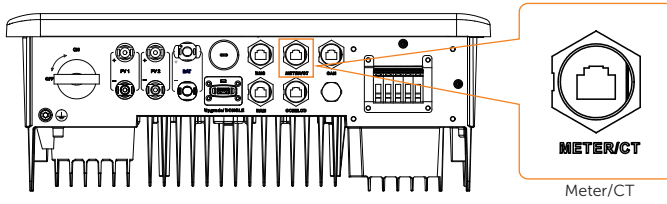

Table 8-5 Pin assignment of Meter/CT terminal

Pin	Pin assignment
1	CT1_1
2	/
3	CT2_1
4	485A
5	485B
6	CT2_2
7	/
8	CT1_2

8.6.2 Meter/CT Connection

The inverter should work with an electric meter or current transformer (CT for short) to monitor household electricity usage. The electricity meter or CT can transmit the relevant electricity data to the inverter or platform.

 CAUTION!

- The inverter will prompt a **Meter Fault** alarm if meter is selected in the LCD screen but not connected to inverter. Smart meters must be authorized by our company. Unauthorized meter may be incompatible with the inverter, thereby resulting in inverter damage and working mode malfunction. SolaX will not be responsible for the impact caused by the use of other appliances.

NOTICE!

- Do not place the CT on the N wire or ground wire.
- Do not put CT on the N wire and L wire at the same time.
- Do not place the CT on the side where the arrow points to the inverter.
- Do not place the CT on non-insulated wires.
- The cable length between CT and inverter should not exceed 100 meters.
- It is recommended to wrap the CT clip around in circles with insulating tape.

NOTICE!

- Please make PE connection for Meter if the meter has ground terminal.

8.6.3 Meter/CT Wiring procedure

Step 1: Disassemble the waterproof connector with RJ45 (Part E) to a waterproof connector and an RJ45 terminal (terminal A).

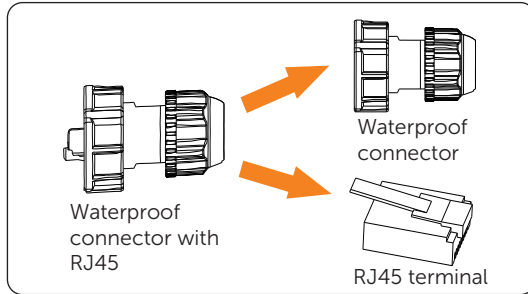

Figure 8-31 Disassembling the waterproof RJ45 connector

Step 2: Thread the communication cable through the waterproof connector.

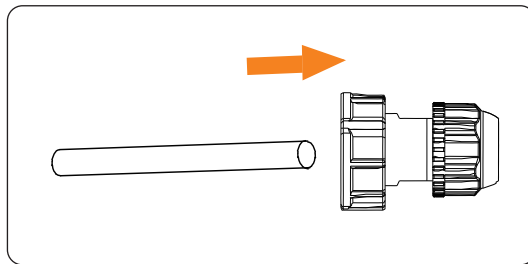

Figure 8-32 Threading the communication cable

Step 3: Strip and crimp the communication cable.

- » For CT connection
 - a. Strip around 15 mm wire insulation off both ends of the cable.

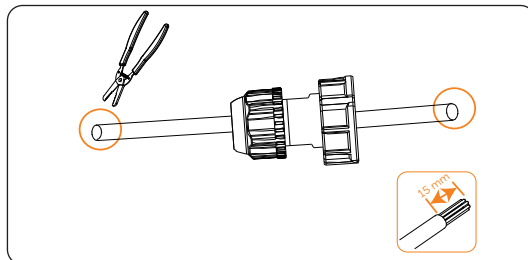

Figure 8-33 Stripping the communication cable for CT

- b. Insert the conductors at both ends respectively to terminal A and another RJ45 terminal (Terminal B) based on the pin definition of the inverter CT/ Meter port, and then use a crimping tool to crimp both cable ends.

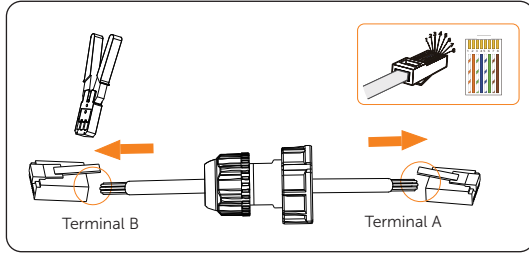

Figure 8-34 Crimping the communication cable for CT

Table 8-6 Pin number and color

PIN No.	Color	PIN No.	Color
1	Orange-White	5	Blue-White
2	Orange	6	Green
3	Green-White	7	Brown-White
4	Blue	8	Brown



» For meter connection

- a. Strip around 15 mm wire insulation off one end of the communication cable.

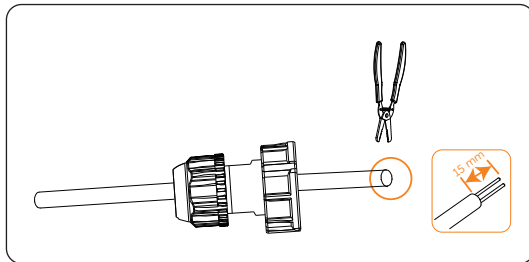

Figure 8-35 Stripping the communication cable for meter

- b. Insert the conductors respectively into pin 4 and pin 5 of the RJ45 terminal, and then use a crimping tool to crimp them.

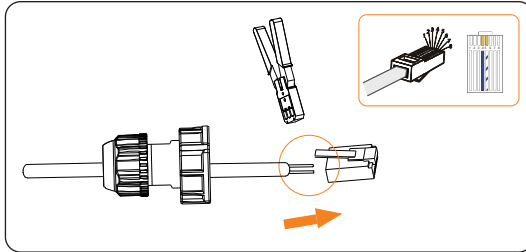

Figure 8-36 Crimping the communication cable for meter

- Step 4:** Remove the dustproof cover from the CT/Meter port of the inverter, insert the RJ45 terminal into the port, and then secure the waterproof connector.

An audible "Click" will be heard if it is successfully connected.

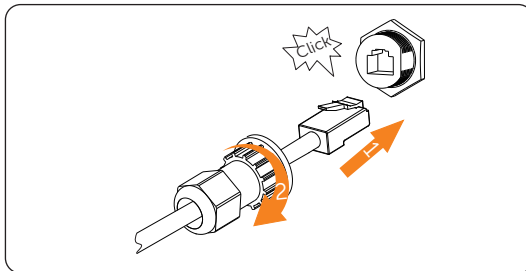
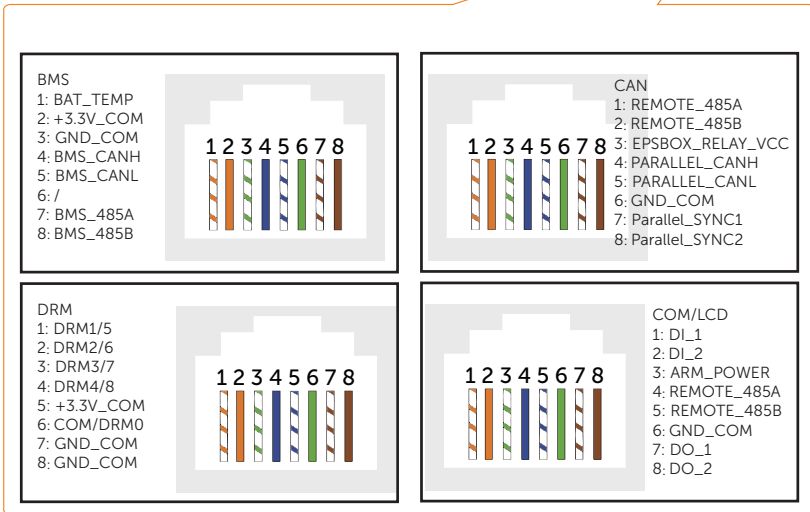
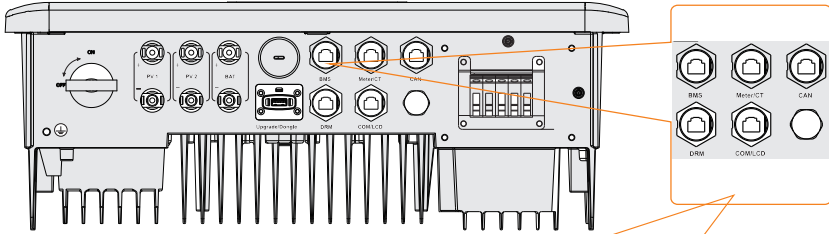

Figure 8-37 Connecting cable to the Meter/CT port

8.7 COM Communication Connection (BMS/CAN/COM/LCD/DRM)

The COM terminal is used for battery communication via BMS; parallel connection via CAN communication terminal; external communication via COM/LCD; and DRM (Demand Response Mode) terminal is used to control the inverter to response.



8.7.1 BMS Communication Connection

Through BMS communication terminal, the inverter can be connected to the batteries.

BMS connection diagram

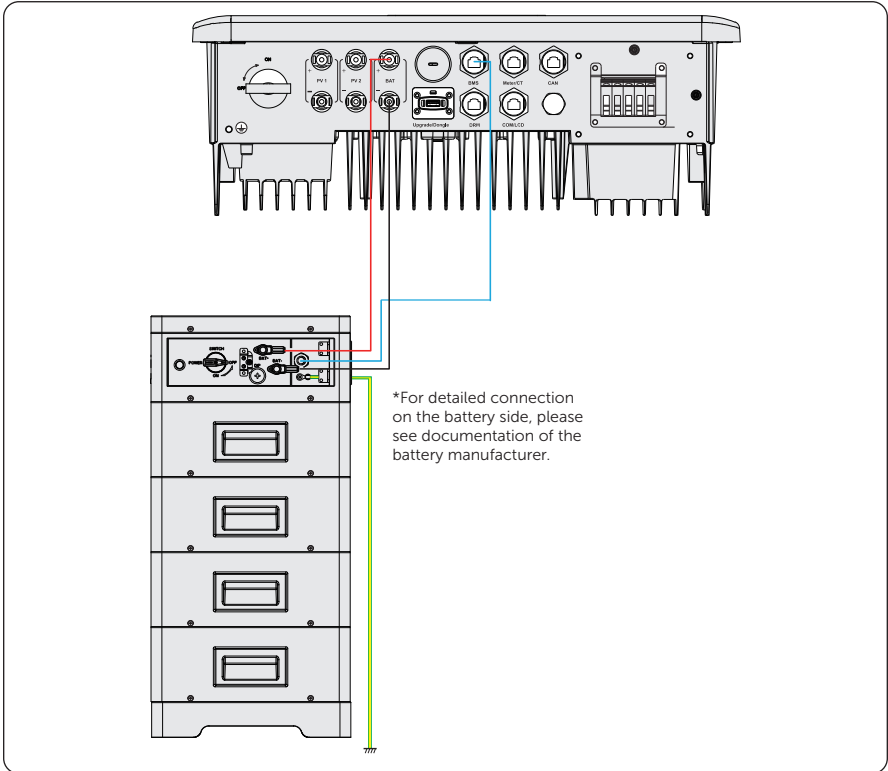

Figure 8-38 BMS connection diagram

8.7.2 CAN Connection (Parallel Connection)

The inverter provides the parallel connection function. One inverter will be set as the **Master** inverter to control the other **Slave** inverter in the system. For details, please refer to "15.6 Application of Parallel Function".

8.7.3 COM/LCD Communication Connection

The inverter supports communication with Adapter Box G2, EV-Charger, DataHub etc via COM/LCD terminal. Please refer to "15 Appendix" for the specific application of Adapter Box G2, EV-Charger and DataHub.

8.7.4 DRM Connection (Applicable to AS/NZS 4777.2)

According to AS/NZS 4777.2, the inverter needs to support the function of demand response mode (DRM). With the use of an external control box, active or reactive power regulation can be realized in a timely and fast manner, and the inverter can be operated stably during the process of regulation.

DRM 0, DRM 1 and DRM 5 are available now.

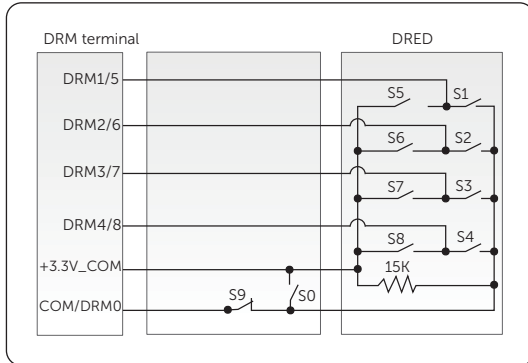

Figure 8-39 DRED connection diagram

Table 8-7 Descriptions of DRM

Mode	Pin	Requirement
DRM 0	Pin 6	<ul style="list-style-type: none"> When S0 is turned on, the inverters shut down. When S0 is turned off, the inverters restore grid connection.
DRM 1	Pin 1	<ul style="list-style-type: none"> When S1 is turned on, the inverters do not input active power.
DRM 5	Pin 1	<ul style="list-style-type: none"> When S5 is turned on, the inverters do not output active power.

8.7.5 BMS/CAN/COM/LCD/DRM Wiring procedure

Step 1: Thread the communication cable through the waterproof connector. And strip around 15 mm wire insulation off one end of the cable.

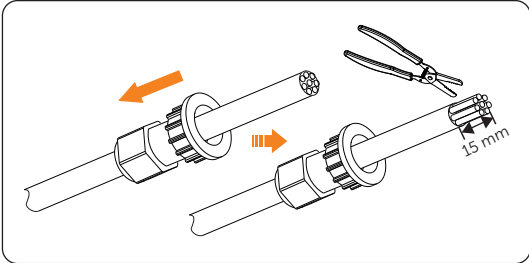

Figure 8-40 Threading the communication cable

Step 2: Insert the conductors to RJ45 terminals based on the pin definition of the inverter BMS/CAN/COM/LCD/DRM port, and then use a crimping tool to crimp them.

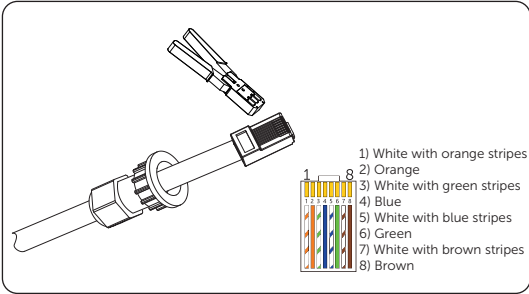

Figure 8-41 Crimping the communication cable

Step 3: Find the BMS/CAN/COM/LCD/DRM ports on the inverter. Remove the dustproof covers of these ports, and then insert the RJ45 terminals into the corresponding ports. An audible "Click" will be heard if it is successfully connected.

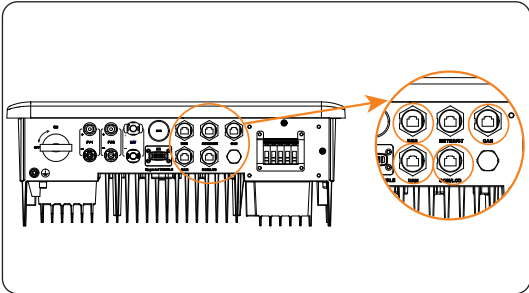

Figure 8-42 Finding the BMS/CAN/COM/LCD/DRM terminals

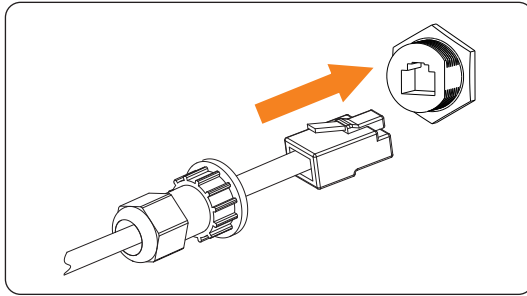

Figure 8-43 Inserting the RJ45 terminals into the ports

Step 4: Tighten the swivel nuts of BMS/CAN/COM/LCD/DRM ports.

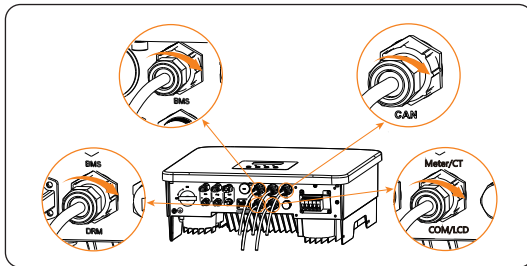

Figure 8-44 Tightening the swivel nuts

NOTICE!

- The DRM port is for Australia only.

8.8 Monitoring Connection

The inverter provides a Dongle terminal, which can transmit data of the inverter to the monitoring website via WiFi+LAN dongle. The WiFi+LAN dongle is equipped with two kinds of communication modes (Wi-Fi mode or LAN mode). Users can choose based on actual needs. (If needed, purchase products from us.)

Monitoring connection diagram

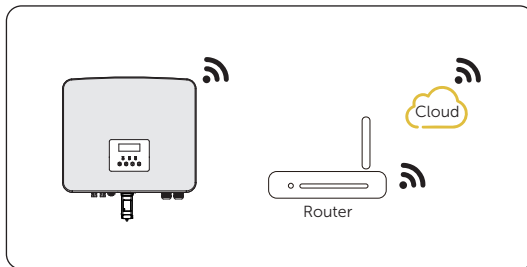

Figure 8-45 Wi-Fi mode connection diagram

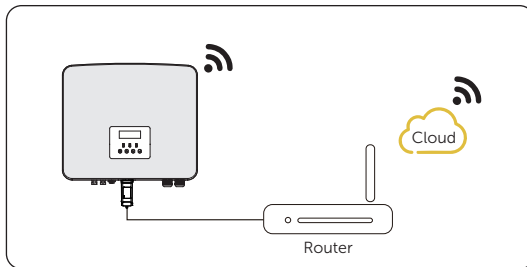

Figure 8-46 LAN mode connection diagram

Monitoring wiring procedure

Wi-Fi mode:

- a. Assemble the dongle.

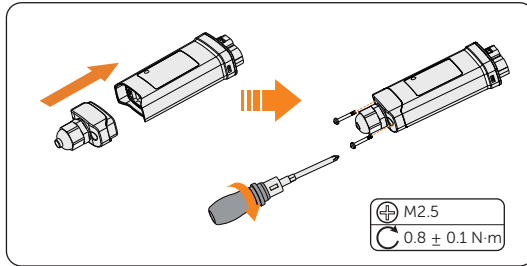

Figure 8-47 Assembling the dongle

- b. Plug the dongle to the inverter.

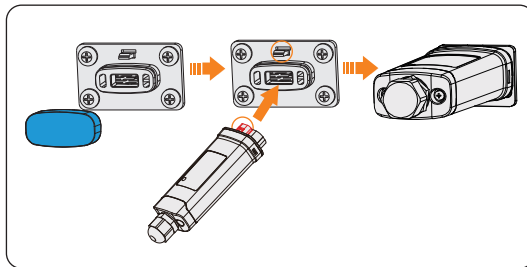

Figure 8-48 Dongle connection procedure

CAUTION!

- The buckles on the inverter and dongle must be on the same side. Otherwise, the dongle may be damaged.

NOTICE!

- The distance between the router and the inverter must be no more than 100 meters. If there are walls in between, the distance must be no more than 20 meters.
- For locations where Wi-Fi signals are weak, install a Wi-Fi signal booster.

NOTICE!

- For details on Wi-Fi configuration, see *Pocket WiFi + LAN Installation Manual*. You can configure Wi-Fi only after the inverter is powered on.

LAN mode:

- a. Disassemble the waterproof connector into components 1, 2, 3 and 4; Component 1 is not used. Keep it in a safe place.

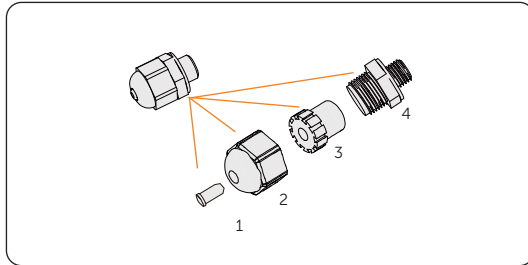

Figure 8-49 Disassembling the waterproof connector

- b. Assemble the dongle.

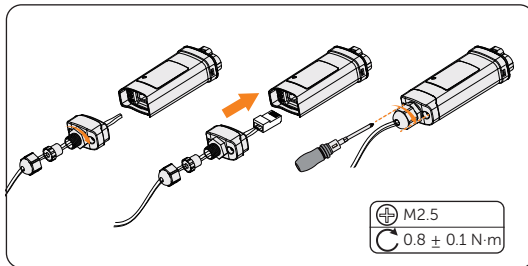

Figure 8-50 Assembling the dongle

- c. Plug the dongle to the inverter.

9 System Commissioning

9.1 Checking before Power-on

No.	Item	Checking details
1	Installation	The inverter is installed correctly and securely. The battery is installed correctly and securely. Other device (if any) is installed correctly and securely.
2	Wiring	All DC, AC cables and communication cables are connected correctly and securely; The meter/CT is connected correctly and securely. The ground cable is connected correctly and securely;
3	Breaker	All the DC breakers and AC breakers are OFF;
4	Connector	The external AC and DC connectors are connected; The connectors on the Grid and EPS (Off-grid) terminal are connected correctly and securely.
5	Unused terminal	Unused terminals and ports are locked by waterproof caps. Unused PV terminals are locked by dustproof buckles.
6	Screw	All the screws are tightened.

9.2 Powering on the System

Step 1: Turn on the DC switch and check the LCD screen.

- » If the LCD screen is not on, turn off the DC switch and check whether the PV polarity is connected correctly.
- » If the error of any channel of PV is displayed on LCD, turn off the DC switch and check the corresponding channel of PV connection.

Step 2: Set **Safety Code** according to different countries and grid-tied standards on the LCD screen. The inverter cannot be connected to the grid before the safety code is correctly set.

Step 3: Set the **System ON/OFF** to ON state on the LCD screen.

Step 4: Switch on the AC breaker and wait for the inverter to power on. After powering on the inverter, you can check whether Meter/CT is correctly connected.

- » If CT is connected, please perform the **Meter/CT Check** on the LCD screen to check the correct connection.
- » If meter is connected, please set the connection of meter through **Meter/CT Settings** and perform the **Meter/CT Check** on the LCD screen.
- » If Meter/CT is successfully connected, the power information of Meter/CT will be displayed on the LCD screen. If the Meter/CT connection fails, the screen will prompt "**Meter Fault**" or "**Missed CT Fault**".

Step 5: Switch on the battery or the breaker, button, DC switch of the battery (see documentation of the battery manufacturer).

Step 6: Check the LCD screen and perform **Forced Discharge** and **Forced Charge** through the setting path **Menu>Work Mode >Manual** to verify if the charging and discharging of battery is normal.

9.3 Lockable DC Switch

This series of inverters are provided with two kinds of DC switches: unlockable DC switch (optional; without lock); and lockable DC switch (standard; with lock).

- For lockable DC switch:

The lockable DC switch includes 3 states: ON, OFF, and OFF+Lock. The DC switch is in the OFF state by default.

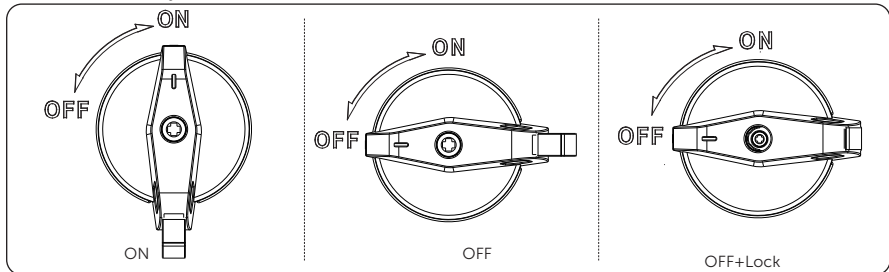

- To turn on the DC switch
 - i) Turn on the DC switch from OFF state to ON state.

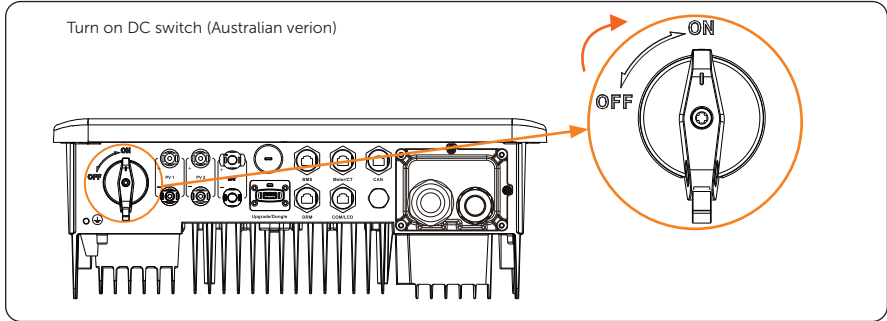

- To turn off the DC switch
 - i) Rotate the DC switch from ON state to OFF state.

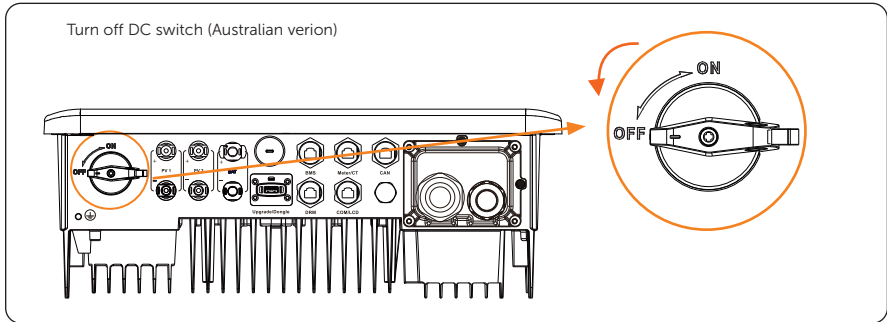

- To lock the DC switch
 - i) Turn off the DC switch
 - ii) Press the position indicated by the arrow ,then lock the DC switch with a lock.

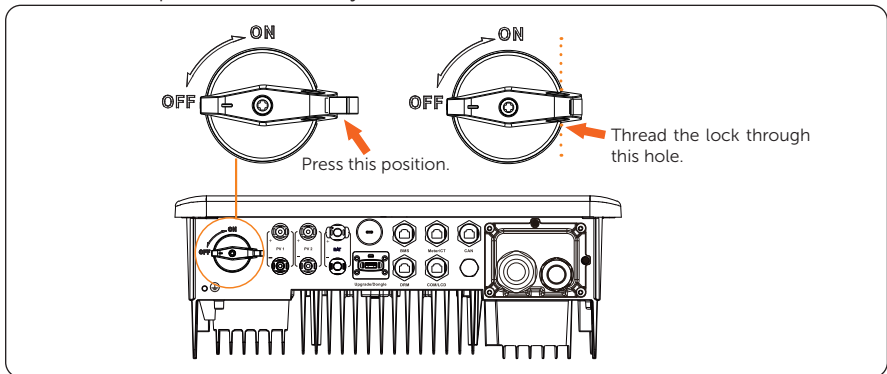

- To unlock the DC switch
Open the lock and remove it, the DC switch will return to OFF state automatically.

10 Operation on LCD

10.1 Introduction of Control Panel

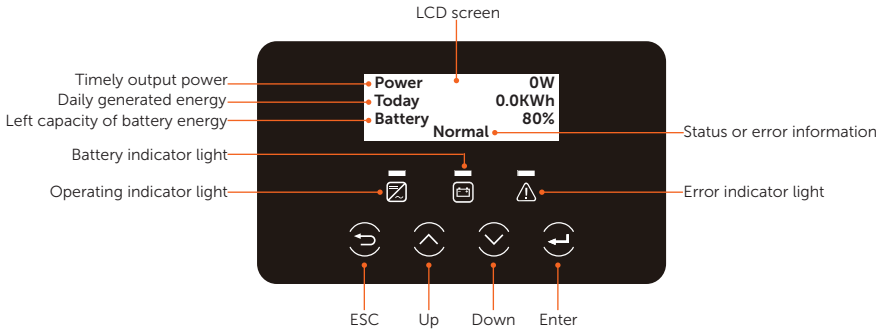









Figure 10-1 Control Panel

- In a normal state, the **Power**, **Today** and **Battery** information will be displayed. You can press the keys to switch information.
- In an error state, the fault message and error code will be displayed, please refer to "[12.2 Troubleshooting](#)" for corresponding solutions.

Table 10-1 Definition of indicators

LED indicator	Status	Definition
 Operating	 Light on	The inverter is in normal status or EPS (Off-grid) mode.
	 Blinking	The inverter is in waiting, checking status or the system switch is off.
	 Light off	The inverter is in fault status.
 Battery	 Light on	The battery communication is in normal status and working normally.
	 Blinking	The battery communication is in normal status and in an idle status.
	 Light off	The battery does not communicate with the inverter.



Light on





The inverter is in fault state.



Light off

The inverter is in norml status.

Table 10-2 Definition of keys

Key	Definition
 ESC key	Exit from the current interface or function
 Up key	Move the cursor to the upper part or increase the value
 Down key	Move the cursor to the lower part or decrease the value
 Enter key	Confirm the selection

10.2 Introduction of Menu Interface

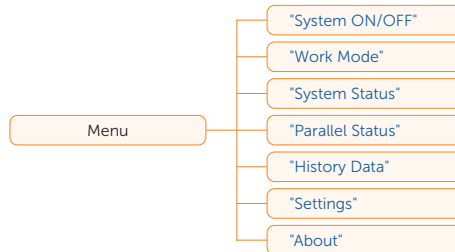

There are seven submenus in the menu that can be selected for relevant setting operations.

- **System ON/OFF:** Switch on and off the inverter.
- **Work Mode:** Select the working mode of the inverter, including **Self Use, Feed-in Priority, Backup Mode, Manual, Peaking Shaving** and **TOU Mode**.

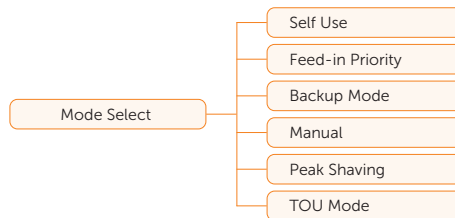

- **System Status:** Display the real-time value of PV, battery, etc. Including **PV1**, **PV2**, **Battery**, **On-grid** and **Meter/CT**.

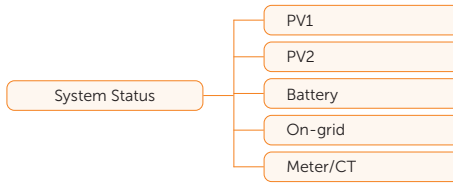

- **Parallel Status:** Display all the status data from master inverter when the inverters are parallel-connected.
- **History Data:** Display the history data of **On-grid**, **EPS**, **Meter/CT_1**, **Meter/CT_2** and **Error Log**.

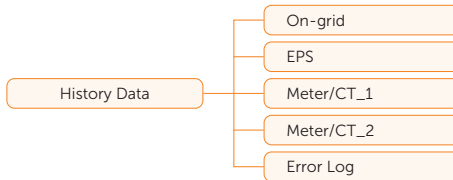

- **Setting:** Set the parameters of the inverter, including **User Setting** and **Advance Setting**.

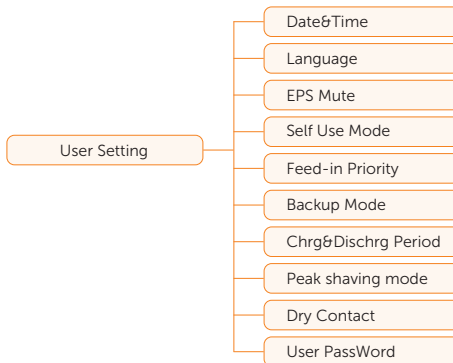

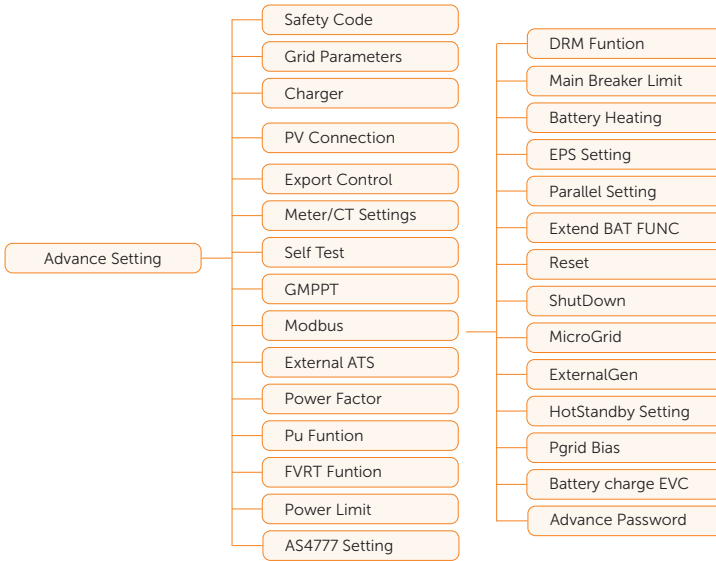

- **About:** Display the information about **Inverter**, **Battery 1**, **Battery 2**, **Internal code** and **ARC Info**.

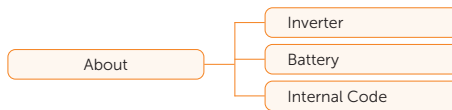

10.3 System ON/OFF

Setting path: **Menu>System ON/OFF**

Select **ON** or **OFF** to switch on and off the inverter. The interface is displayed **OFF** by default. When you select **ON**, the inverter starts running and displays **System ON**.

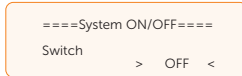

10.4 Work Mode

Selecting path: **Menu>Work Mode**

Here you can only select the working mode. Six working modes are available for you to choose in on-grid status, i.e Self Use mode, Feed-in Priority, Backup, Peak shaving mode, TOU Mode and Manual. You can choose the working modes according to your lifestyle and environment. Please refer to "[2.7 Working Mode](#)" for introduction of the modes and "[10.7.1 User Setting](#)" for specific setting of each mode.

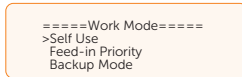

After entering into the Work Mode interface, you can set **Self Use**, **Feed-in Priority**, **Backup Mode**, **Manual**, **Peak shaving** and **TOU** as follows:

- » Selecting **Self Use**

Feed-in Priority, **Backup Mode**, **Peak Shaving** and **Manual** have the same setting logic as **Self Use**.

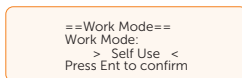

- » Selecting **TOU**

TOU can only be set in SolaX Cloud App. After setting the TOU in the App, the selected TOU mode will be displayed in TOU interface on the LCD.

Min SoC: The minimum SoC of the system.

Min Soc: Default: 10%

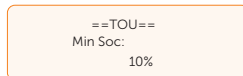
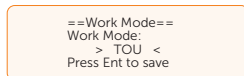

Self Use: Same working logic with "**Self Use Mode**", but it is not limited by the charging and discharging time slots. The priority of PV: Loads > Battery > Grid.

Min Soc: Default: 10%



Battery off: The battery neither charges nor discharges. The power of PV will supply to loads or the grid. Only when the battery SOC is lower than the system (TOU) **Min SOC**, the battery can be charged.

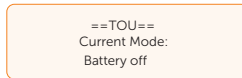

Peak shaving: The working logic is that when the power consumption from the grid exceeds the set PeakLimit value, the battery is allowed to discharge power. The excess power beyond the limit is provided by the combination of photovoltaic and battery to ensure that the maximum power purchased from the grid does not exceed the set limit.

Peaklimits: Default: 0W; range:0~60000W



Charging: The power of PV will charge the battery as much as possible to the set SOC of **Charge BAT to (%)**. You can set whether to Charge from grid. The default value of **Charge BAT to (%)** is 100%. When the battery reaches the set SOC, the surplus power will perform "**Self Use Mode**" or supply to the grid (based on the system setup), at this point, Charge from grid is not allowed.

Charge from grid: Default: Disable

Charge BAT to: Default: 100%; range:10%~100%

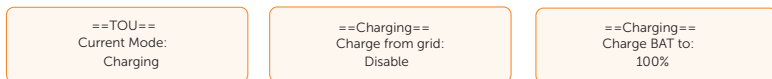

Discharging: If allowed by the battery, the system outputs a specified power from the grid based on the set output percentage, controlling the power at the AC port. You need to set the RatePower (%) through Web or App when choosing Discharging mode. When the battery Discharge to (%) reaches the set SOC, the inverter performs "Self-use Mode".

Rate of AC Power: Default: 100%; range:0%~100%

Discharge to: Default: 10%; range:10%~100%

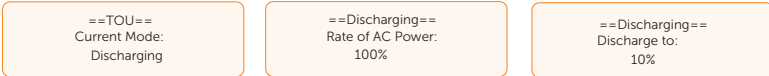

10.5 System Status

Displaying path: **Menu>System Status**

After entering into the **System Status** interface, the status of PV, Battery, On-grid, Meter/CT will be displayed on the LCD as follows:

- PV status: You can see information of **PV1** and **PV2**. Information contains input voltage, current and power of each PV.



- Battery status: There will be information of **Battery** displayed here. It shows the status of the battery terminal, including the voltage, current, power, SOC, cell temperature and BMS connection status. Positive value with power means charging; negative value means discharging.

a. For lithium-ion battery

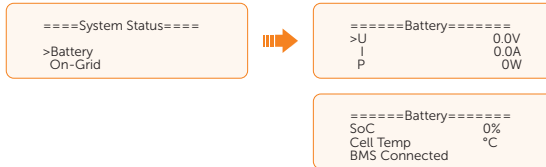

b. For Lead-acid battery

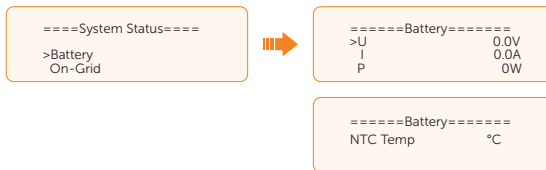

- On-grid status: Information contains the voltage, current, output power and frequency of Grid terminal. Positive value with power means power output; negative value means power input.

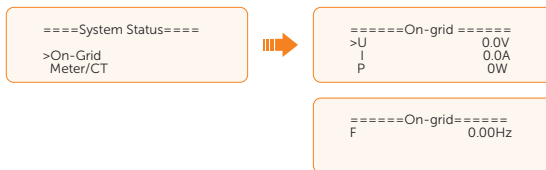

- Meter/CT status: Information contains feed-in power detected by the connected meter or CT. Positive value means power fed into grid; negative value means power taken from grid.



10.6 History Data

Displaying path: **Menu>History Data**

After entering the **History Data** interface, the status of **On-grid**, **EPS (Off-grid)**, **Meter/CT_1**, **Meter/CT_2**, **Error Log** will be displayed on the LCD as follows:

- **On-grid**: A record of the output and input electric energy of the inverter today and the total (through Grid terminal).
 - » **Output Today**: Output electric energy of the inverter today.
 - » **Output Total**: Total output electric energy since the inverter activated for the first time.
 - » **Input Today**: Input electric energy of the inverter today.
 - » **Input Total**: Total input electric energy since the inverter activated for the first time.

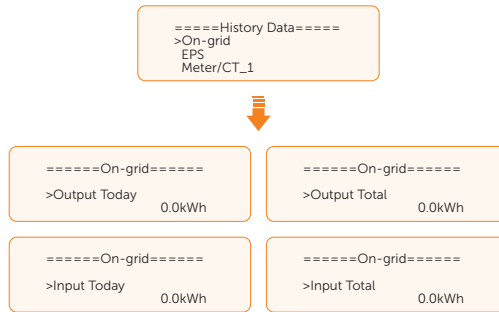

- **EPS (Off-grid)**: A record of the output electric energy of the inverter today and the total, when it is disconnected from grid (through EPS (Off-grid) terminal).

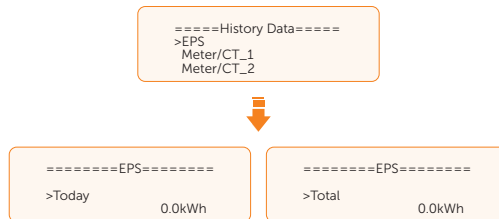

- **Meter/CT_1**: The total electricity fed into or taken from the grid since the inverter activated for the first time and on that day (detected by Meter/CT).
 - » **Feedin Today**: Electricity sold to grid today.
 - » **Feedin Total**: Total electricity sold to grid since the inverter activated for the first time.
 - » **Consume Today**: Electricity bought from grid today.

- » **Consume Total:** Total electricity bought from grid since the inverter activated for the first time.

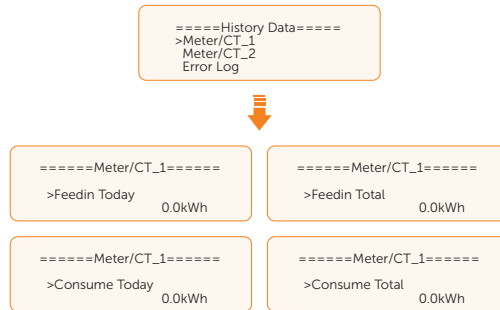

- **Meter/CT_2:** The output electricity of the connected on-grid inverter today and the total (detected by Meter 2). This function is only available when meter 2 is connected.

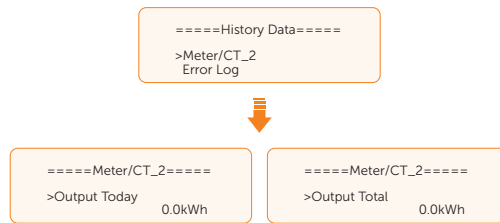

- **Error Log:** Display the recent six error messages. Information contains date and time error happened, error code and error description.



10.7 Setting

Settings includes User Settings and Advanced Settings.

10.7.1 User Setting

Setting path: **Menu>Setting ("0 0 0 0")>User Setting**

NOTICE!

The default password for **User Setting** is "0 0 0 0".

Setting Date & Time

You can set the current date and time of the installation site.

The display format is "2024-06-16 14:00", in which the first four numbers represent the year (e.g. 2000~2099); the fifth and sixth numbers represent the month (e.g. 01~12); the seventh and the eighth numbers represent the date (e.g. 01~31). The remaining numbers represent the time.



Setting Language

This inverter provides multiple languages for customers to choose, such as English, Deutsch, francais, Polskie, Espanol, Português. The default language is English.



Setting EPS (Off-grid) Mute

When the inverter is running in EPS (Off-grid) Mode, you can choose whether the buzzer is turned on or not.

- Select **Yes**, the buzzer mutes.
- Select **NO**, the buzzer will sound every 4 seconds when the battery SOC is > EPS min. SOC. When the battery SOC is equal to EPS min. SOC, the buzzer will sound with higher frequency at every 400 ms. This function is turned on by default.



Setting Self Use Mode

Please refer to "2.7.1 Self-use Mode" for working logic of this mode.

- **Min SOC:** Default: 10%; range: 10%~100%
 - » The minimum SOC of the battery. The battery will not discharge power when the SOC of the battery reaches this value.



- **Charge from grid:**
 - » You can set whether the power can be taken from the grid to charge the battery in the forced charging period. When **Charge from grid** is set to **Enable**, the grid power is allowed to charge the battery; when it is set to **Disable**, the grid power is not allowed to charge the battery.



- **Charge battery to:** Default: 30%; range: 10%~100%
 - » Set the target SOC to charge the battery from grid in the forced charging period (applicable only when the **Charge from grid** is enabled).
 - » You can set your own target value, i.e. during the forced charging period, the inverter will use both PV & grid power to charge the battery to the target value. If the PV power is still sufficient (enough for load and there is excess power), the inverter will continue to charge the battery.

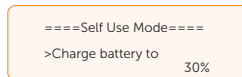

Setting Feed-in Priority

Please refer to "2.7.2 Feed-in Priority" for working logic of this mode.

- **Min SOC:** Default: 10%; range: 10%~100%
 - » The minimum SOC of the battery. The battery will not discharge power when the SOC of the battery reaches this value.



- **Charge battery to:** Default: 100%; range: 10%~100%
 - » Set the target SOC to charge the battery from grid in the forced charging period.

- » You can set your own target value, i.e. during the forced charging period, the inverter will use both PV & grid power to charge the battery SOC to the target SOC value, after the battery SOC meets the target value, if the PV power is still sufficient, the surplus power will be fed into the grid.

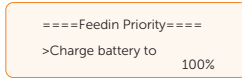

Setting Backup Mode

Please refer to "2.7.3 Backup Mode" for working logic of this mode.

- **Min SOC:** Default: 30%; range: 30%~100%
 - » The minimum SOC of the battery The battery will not discharge power when the SOC of the battery reaches this value.

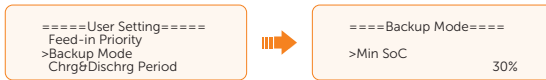

- **Charge battery to:** Default: 50%; range: 30%~100%
 - » In this mode, the charge from grid function is turned on by default, and customers can set the target value by themselves, that is, during the forced charging period, the inverter will use both PV & grid power to charge the battery to the target value. If the PV power is still sufficient (enough for load and there is excess power), the inverter will continue to charge the battery.

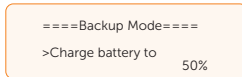

Setting Chg&Dischg Period

Here you can set the **Forced Chg Period** and **Allowed Dischg Period**.

If two charging and discharging periods are needed, enable the **Function Control** to activate the **Chg&Dischg Period2**.

- **Chg&Dischg Period:** You can set the charge and discharge time according to your own needs. The default time axis of the system is 24h.
 - » **Forced Chg Period Start Time:** Time to start charging; default: 00:00; range: 00:00~23:59
 - » **Forced Chg Period End Time:** Time to stop charging; default: 00:00; range: 00:00~23:59
 - » **Allowed Dischg Period Start Time:** Time allows to start discharging (The charging or discharging of the battery depends on the working mode.); default: 00:00; range: 00:00~23:59

- » **Allowed Dischg Period End Time:** Time to stop discharging; default: 23:59; range: 00:00~23:59

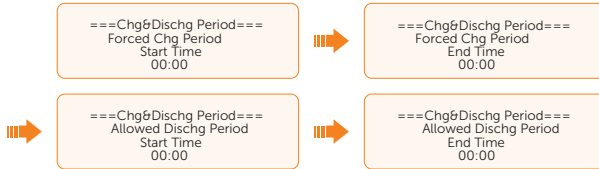

- **Chg&Dischg Period2:** The second time axis is closed by default. If two charging and discharging periods are needed, turn on the charging and discharging period 2. This period will hold the same setting logic as **Chg&Dischg Period**.

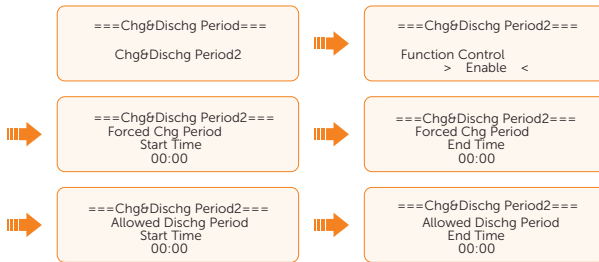

NOTICE!

- The charging and discharging period is only applicable for self-use mode, feed-in priority and backup mode.
- In the period not set as forced charging period and allowed discharging period, the battery can be charged but can not discharge power.
- In the period simultaneously set as forced charging period and allowed discharging period, the battery will be charged forcibly.

Setting Peak shaving mode

Please refer to "2.7.4 Peak Shaving Mode" for working logic of this mode.

- **DisChgPeriod1:** To set **ShavingStartTime**, **ShavingEndTime** and **PeakLimits**. **DisChgPeriod1** can be regarded as Peak shaving period. This period should be set to cover load peaks. Battery will be discharged to shave load peak until battery SOC drops to Min SOC (10% by default).
 - » **ShavingStartTime:** Default: 7:00
The battery starts discharging to shave consumption from the set time.

- » **ShavingEndTime:** Default: 15:00

The battery stops discharging at the set time.

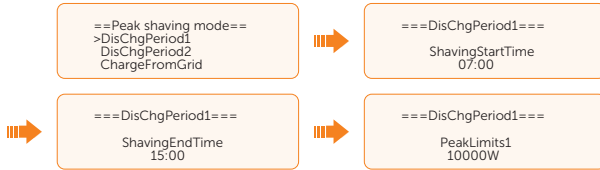

- » **PeakLimits1:** Default: 0 W, range: 0-60000 W

Once the consumption (from the grid) reaches this value, the inverter will start shaving to keep the consumption lower than this value.

- **DisChgPeriod2:** Same working logic with DisChgPeriod1

- » **ShavingStartTime:** Default: 19:00

The battery starts discharging to shave consumption from the set time.

- » **ShavingEndTime:** Default: 23:00

The battery stops discharging at the set time.

- » **PeakLimits2:** Default: 0 W, range: 0-60000 W

- **ChargeFromGrid:** It can be used in specific time period. This period allows the inverter to take energy from grid to charge battery in order to have enough backup for peak shaving. Please note that this period starts from ShavingEndTime2, end until ShavingStartTime1.

- » **Enable:** Activate the function of **ChargeFromGrid** to allow the inverter taking grid energy to charge battery. The **ChargePowerLimits** and **MAX_SOC** will be displayed only when **ChargeFromGrid** is enabled.

- » **ChargePowerLimits:** Default: 1000 W; range: 0-60000 W

Settable target power taken from grid. Inverter will use this target power taken from grid to charge battery.

- » **MAX_SOC:** Default: 50%; range: 10%-100%

Inverter will take grid energy to charge battery until battery SOC reaches this value.

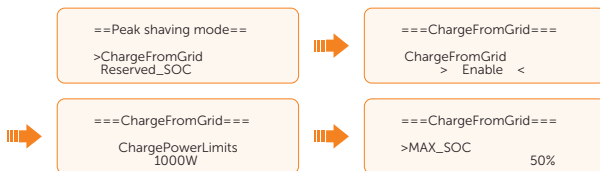

- **Reserved_SOC**: Default: 50%; range: 10%-100%
 - » It can be used in specific time period. In this period, the inverter does not allow taking grid energy to charge the battery. PV is the only way to charge the battery and PV will charge the battery first. Inverter will not supply power to loads until battery SOC is higher than the **Reserved_SOC** in order to save enough energy for later shaving period.



Setting Dry Contact

This function is applicable for the first generation of SolaX Adapter Box.

- a. Enter the **Load Management** interface through the path: **Menu>Setting>User Setting>Dry Contact**
- b. Set the **Load Management** mode. Overall three heat pump operation modes are available for you to choose:

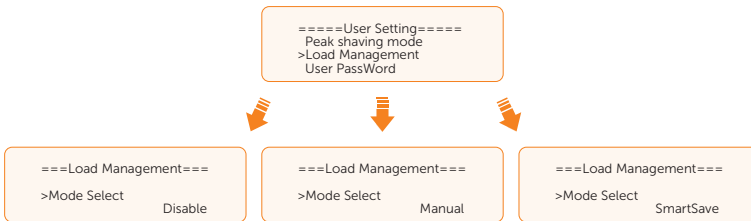

- » Mode 1 **Disable**: The Adapter Box function is disabled under this operation mode.
 - » Mode 2 **Manual**: In this operating mode, you can change the Adapter Box from on to off, or from off to on through settings on the inverter or through SolaX App.
 - » Mode 3 **SmartSave**: In this operating mode, users can set a series of parameters on the SolaX inverter to intelligently control how and when the heat pump works for them (see Step C).
- c. Set the parameters for mode **SmartSave**. In this mode, you can set **Thresholds on Feedin power**, **Thresholds off Consumption**, **Thresholds off Battery SOC**, **Mnimum duration per on-signal**, **Minimum duration per day** and **Schedule** in accordance with your actual needs.

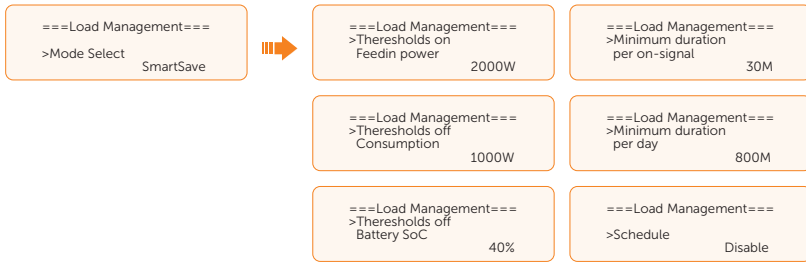

- Setting thresholds on/off
 - » **Thresholds on Feedin power:** Once the feed-in power is greater than or equal to the set value, the Adapter Box will turn on and the heat pump will heat the water up to a higher temperature.
 - » **Thresholds off Consumption:** Once the power consumption (from the grid) is greater than or equal to the set value, the Adapter Box will be turned off, SolaX system stops providing electricity to heat pump.
 - » **Thresholds off Battery SOC:** Once the battery SOC drops to the set value, the Adapter Box will turn off, SolaX system stops providing electricity to heat pump.
- Setting minimum / maximum duration
 - » **Minimum duration per on-signal:** Minimum working hours, heat pump will work at least the time set here every time been activated. High priority than other power threshold settings.
 - » **Maximum duration per day:** Maximum working hour limitation per day. High priority than other power threshold settings.
- Setting schedule
 - » **Schedule:** Set the heat pump working periods flexibly (heat pump on and off periods). High priority than other power threshold settings. Two work periods can be set.

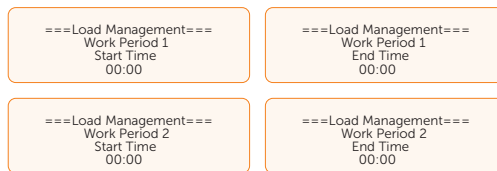

- Mode Priority: **Minimum/Maximum duration > Schedule >Thresholds on/off**
- d. When the power of loads are greater than that of the inverter, you can set the **Generator** to supply loads.

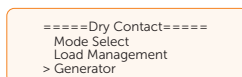

Setting User Password

The default password is "0 0 0 0". You can reset the password here.

10.7.2 Advanced Setting

Setting path: **Menu>Setting>Advance Setting**

NOTICE!

- All the adjustable parameters including safety code, grid parameter, export control, etc. can be modified under the permissions of installer password. Unauthorized use of the installer password by unauthorized persons can lead to incorrect parameters being inputted, resulting in power generation loss or violation of local regulation. Get the installer password from the dealer and never open the password to unauthorized person.

Setting Safety Code

NOTICE!

- The inverter cannot be connected to the grid before the safety code is correctly set. If there is any doubt about your safety code where the inverter installed, please consult your dealer or SolaX service for details.
- The setup will vary from different safety codes.

Here you can set safety code according to different countries and grid-tied standards. In addition, the inverter has an **User Defined** option which allows you to customize relevant parameters with a wider range.

There are several standards to choose from, please refer to the LCD screen on the inverter. (May be changed or added without notice)

Table 10-3 Safety code

Safety code	Country
TOR	Austria
G99	United Kingdom
TR	Denmark
EN50549-EE	Estonia
EN50549-SE	Sweden
AS 4777.2	Australia
CEI0-21	Italy

Operation on LCD

Safety code	Country
C10/26	Belgium
G100 NI	Northern Ireland
VDE4105	Germany
PEA	Thailand

For Australia, select Australia Region A / B / C in compliance with AS/NZS 4777.2. Only after the safety code setting is completed, some designated parameters in the inverter system will take effect according to the corresponding safety regulations.

Table 10-4 Region settings

Region	Australia A	Australia B	Australia C	New Zealand	
Standard Code Name	AS4777_2020_A	AS4777_2020_B	AS4777_2020_C	New Zealand	Setting Range
OV-G-V	265 V	265 V	265 V	265 V	230-300 V
OV-GV1-T	1.5 s	1.5 s	1.5 s	1.5 s	
OV-G-V2	275 V	275 V	275 V	275 V	230-300 V
OV-GV2-T	0.1 s	0.1 s	0.1 s	0.1 s	
UN-G-V1	180 V	180 V	180 V	180 V	40-230 V
UNGV1-T	10 s	10 s	10 s	10 s	
UN-G-V2	70 V	70 V	70 V	70 V	40-230 V
UNGV2-T	1.5 s	1.5 s	1.5 s	1.5 s	
OV-G-F1	52 Hz	52 Hz	55 Hz	55 Hz	50-55 Hz
OVGF1-T	0.1 s	0.1 s	0.1 s	0.1 s	
OV-G-F2	52 Hz	52 Hz	55 Hz	55 Hz	50-55 Hz
OVGF2-T	0.1 s	0.1 s	0.1 s	0.1 s	
UN-G-F1	47 Hz	47 Hz	45 Hz	45 Hz	40-50 Hz
UNGF1-T	1.5 s	1.5 s	5 s	1.5 s	
UN-G-F2	47 Hz	47 Hz	45 Hz	45 Hz	45-50 Hz
UNGF2-T	1.5 s	1.5 s	5 s	1.5 s	
Startup-T	60 s	60 s	60 s	60 s	15-1000 s
Restore-T	60 s	60 s	60 s	60 s	15-600 s

Region	Australia A	Australia B	Australia C	New Zealand	
Standard Code Name	AS4777_2020_A	AS4777_2020_B	AS4777_2020_C	New Zealand	Setting Range
Recover-VH	253 V	253 V	253 V	253 V	
Recover-VL	205 V	205 V	205 V	198 V	
Recover-FH	50.15 Hz	50.15 Hz	50.15 Hz	50.15 Hz	
Recover-FL	47.5 Hz	47.5 Hz	47.5 Hz	47.5 Hz	
Start-VH	253 V	253 V	253 V	253 V	
Start-VL	205 V	205 V	205 V	198 V	
Start-FH	50.15 Hz	50.15 Hz	50.15 Hz	50.15 Hz	
Start-FL	47.5 Hz	47.5 Hz	47.5 Hz	47.5 Hz	

Setting Grid parameters

The default value is the specified value under the current safety regulations. The contents will be displayed according to the requirements of local laws and regulations. Please refer to the actual contents displayed on the LCD screen on the inverter.

```
====Grid Parameters====
>Overvoltage_L1
Undervoltage_L1
OverFreq_L1
```

Setting Charger

The inverter is compatible with lithium-ion battery and Lead-acid battery. You can set the charge & discharge parameters of battery.

- a. For lithium-ion battery
 - **Max Charge:** Maximum charging current of battery. Default: 30A, range: 0-30A.
 - **Max Discharge:** Maximum discharging current of battery. Default: 30A, range: 0-30A.
 - **Charger upper limit:** Default: 100%, range: 10%-100%
 - » The maximum battery SOC when charging.

```
====Charger====
>Max Charge
Current
30A
```

```
====Charger====
>Max DisCharge
Current
30A
```

```
====Charger====
>Charger upper limit
100%
```

b. For lead-acid battery

- **Charge Equalization:** When the battery voltage reaches this value, it will enter the constant voltage charging stage. Range: 85V-400V.
- **Charge Float:**When the battery voltage reaches this value, it will enter the float charging stage. Range: 85V-400V.
- **DisCharge Cut:** In on-grid mode, when the battery voltage reaches this value, the battery will stop discharging, and the inverter will enter ILDE mode if there is no PV power supply. In off-grid mode, when the battery voltage reaches this value, the battery will stop discharging, the inverter will stop exporting power from the EPS (Off-grid) port and display "BAT power low" on the LCD display. Range: 85V-400V.
- **DisCharge Backup:** In on-grid mode, when the battery voltage reaches this value, the battery will stop discharging, and the inverter will enter ILDE mode if there is no PV power supply. In off-grid mode, when the battery voltage reaches this value, the battery will stop discharging, the inverter will stop exporting power from the EPS (Off-grid) port and display "BAT power low" on the LCD display. Range: 85V-400V.
- **Max Discharge:** Maximum discharging current of battery. Default: 30A, range: 0-30A.
- **Max Charge:** Maximum charging current of battery. Default: 30A, range: 0-30A.

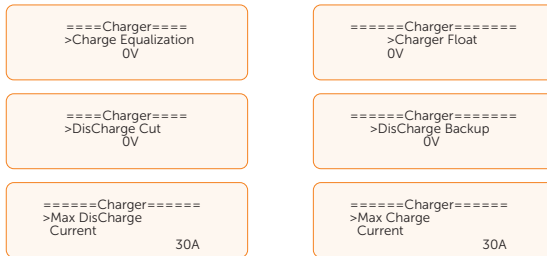

Setting PV Connection

PV connection supports MULTI Mode. MULTI Mode means that each PV module connects to the inverter's one MPPT.

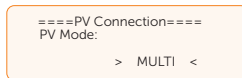

Setting Export Control

This function allows the inverter to control the output power to the grid. The **User Value** set here must be less than the maximum value. If the user does not want to feed power to the grid, set **User Value** to "0".

```
====Export Control====
User Value
60000W
```

NOTICE!

- Under Safety Code AS4777.2, **Export Control** is in the path of **Advance Setting**>**AS4777 Setting**. You can set the **Soft Limit** and **Hard Limit** of **Export Control** to control the power output to grid. Please refer to section "**AS4777 Setting**" for details.

Meter/CT Setting

CT or electricity meter is needed to connect with the inverter. Meter is set by default.

NOTICE!

- If the user has other power generation equipment (such as inverter) at home and wants to monitor both, the inverter provides Meter2 communication function to monitor the power generation equipment.

- Select and enter the **Meter/CT Setting** according to the setting path.
- Set the the parameters of Meter/CT:
 - Case 1: Only CT is connected for the series inverter. No power generation equipment in the whole system. Please activate the CT selection. You can check the connection status in **Meter/CT Check**.

```
====Meter/CTSetting====
>Select  CT
```

- Case 2: Only Meter 1 is connected for the series inverter. No power generation equipment in the whole system. Please activate the meter 1 selection and set the meter address and direction. You can check the connection status in **Meter/CT Check**.

NOTICE!

- CT and meter 1 can not be used simultaneously.



- » Case 3: CT and Meter 2 are connected. (CT for SolaX hybrid inverter, Meter 2 for another power generation equipment or CT for another power generation equipment, Meter 2 for SolaX hybrid inverter) For CT setting, please refer to Case 1. For meter 2 setting, please set the address and direction of Meter2 based on actual connection. You can check the connection status in **Meter/CT Check**.



- » Case 4: Meter 1 and Meter 2 are connected. (Meter1 for SolaX hybrid inverter, Meter 2 for another power generation equipment or Meter 1 for another power generation equipment, Meter 2 for SolaX hybrid inverter). Please refer to Case 2 for Meter 1 setting and Case 3 for Meter 2 setting. You can check the connection status in **Meter/CT Check**.

Setting Self Test (only for CEI 0-21)

The self test function allows users to test the following items: **All Test**, **Test Report**, **Ovp (59.S2) test**, **Uvp (27.s1) test**, **Uvp (27.s2) test**, **Ofp (81>.S1) test**, **Ufp (81<.S1) test**, **Ufp2 (81>.S2) test**, **Ufp2 (81<.S2) test**, **Ovp10 (59.s1) test**.

In the **Self Test** interface, the user can select **All Test** or a single test item for testing. All tests take about 6 minutes. And it will display **Success**. For a single test item, it takes about a few seconds or minutes.

Before testing, make sure that the inverter is connected to the grid. Click **Test Report** to view the test results of all items.

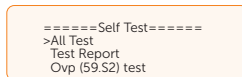

Setting GMPPT

You can set the shadow tracking speed with four options, which are **Off**, **Low**, **Middle**, and **High**. This function is off by default.

- **Off**: Switch off the shadow tracking function.
- **Low**: Scan the shadow every four hours.
- **Middle**: Scan the shadow every three hours.
- **High**: Scan the shadow per hour.

```

=====GMPPT=====
PV1 Control
> Low <
  
```

Setting Modbus

You can set the address and select the baud rate of the external communication protocol for communicating with external equipment.

```

=====Modbus=====
Braud Rate
> 19200 <
  
```



```

=====Modbus=====
>Address
  1
  
```

Setting External ATS

Enable means the inverter achieves grid and off-grid switching through the advanced matebox. **Disable** means the inverter achieves grid and off-grid switching by the inverter itself. (Disable by default)

External ATS needs to be set to Enable only when an advanced matebox is connected. In other cases, Disable this function is required. When the inverter is in Parallel state, Enable can not be set.

```

=====External ATS=====
Select
> Disable <
  
```

Setting Power Factor

The default value is the specified value under the current safety regulations. The contents will be displayed according to the requirements of local laws and regulations. Please refer to local grid requirements.

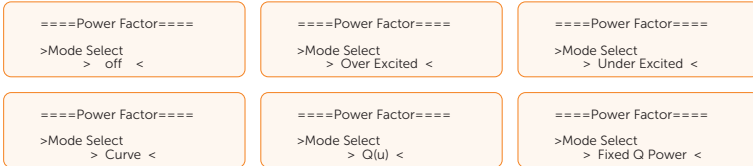

Table 10-5 Items under Power Factor

Off	
Over Excited	PF Value
Under Excited	PF Value
Curve	P1 PF
	P2 PF
	P3 PF
	P4 PF
	Power 1
	Power 2
	Power 3
	Power 4
	PflockInPoint
	PflockOutPoint
	3Tua

	SetQuPower1
	SetQuPower2
	SetQuPower3
	SetQuPower4
	QuRespondV1
Q(u)	QuRespondV2
	QuRespondV3
	QuRespondV4
	K
	3Tua
	QuDelayTimer
	QuLockEn
Fixed Q Power	Q Power

- Reactive power control, reactive power standard curve $\cos \varphi = f(P)$
 - » For VDE ARN 4105, the curve $\cos \varphi = f(P)$ should refer to curve A. The set default value is shown in curve A.

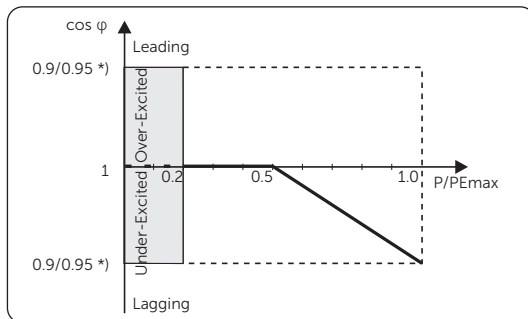

Figure 10-2 Curve A

*) If the grid-connected power of the inverter ≤ 4.6 kW, the Power Factor is 0.95 at 1.0 power; if the grid-connected power of the inverter > 4.6 kW, the Power Factor is 0.90 at 1.0 power.

- » For TOR, the curve $\cos \varphi = f(P)$ should be curve B. The set default value is shown in curve B.

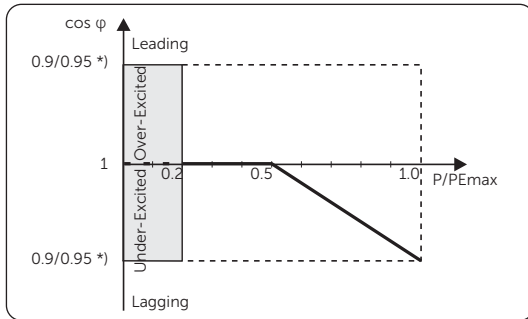

Figure 10-3 Curve B

*) Depend on the required Q capacity

- » For CEI 0-21, the default value of PFLockInPoint is 1.05. When $V_{ac} > 1.05V_n$, $P_{ac} > 0.2 P_n$, curve $\cos \varphi = f(P)$ corresponds to curve C.

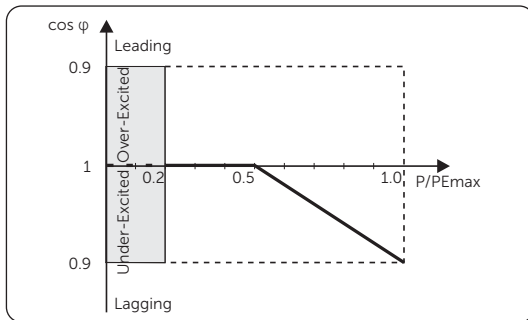

Figure 10-4 Curve C

- Reactive power control, reactive power standard curve $Q = f(V)$

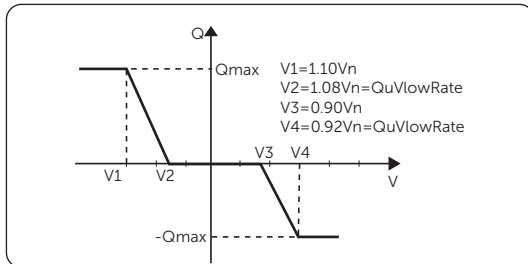

Figure 10-5 Curve $Q = f(V)$

Setting Pu Function

(Applicable to specific countries, please refer to local grid requirements.)

The Pu function is a volt-watt response mode required by certain national standards such as AS/NZS 4777.2. This function can control the active power of the inverter according to the grid voltage. You can set **Response Voltage**, **3Tau** and **PuPower**.

The items in the **P(u) Function** interface will be adjusted in accordance with the local safety requirements and law regulations, casual modification is prohibited.



For AS/NZS 4777.2, the curve required for the volt-watt mode can be referred to the below curve.

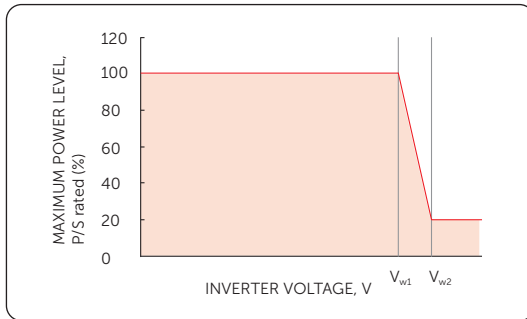
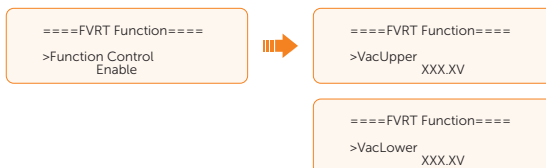

Figure 10-6 Curve for P(u)

Setting PVRT function

PVRT consists of HVRT (High Voltage Ride Through) and LVRT (Low Voltage Ride Through). With PVRT function, the series inverter can ensure continuous operation without disconnecting from the grid within a certain range of voltage sudden rise and drop in a certain time interval.

- **Enable:** Enable the PVRT function
- **VacUpper:** The voltage for high voltage ride through
- **VacLower:** The voltage for low voltage ride through



Setting Power Limit

Here you can set the rated output power by percentage.

The percentage of rated output power is used as the actual output power.

Proportion: Default: 1.00; range: 0.00-1.00

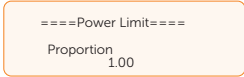

AS4777 Setting

The function of **AS4777 Setting** is only activated when the **Safety Code** is set to AS4777 and New Zealand, which is only applicable to Australia and New Zealand.

- a. Select and enter **AS4777 Setting** in **Advance Settings** interface. You will see **Exprot Control** (for active power output control) and **General Control** (for apparent power output control).

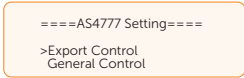

- b. Set the **Soft Limit** value and **Hard Limit** value for Export Control and General Control. The figure below will take the setup of Export Control as an example.

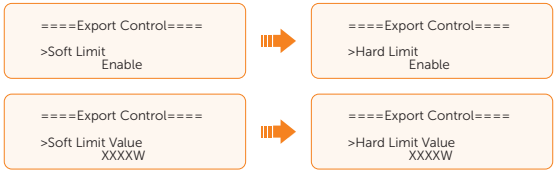

NOTICE!

- **Soft Limit:** Control the output value to grid within the set **Soft Limit Value**.
- **Hard Limit:** If the actual output value reaches the set **Hard Limit Value**, the system will automatically disconnect from grid and prompt error message on the LCD.

Setting DRM function (Applicable to AS/NZS 4777.2)

The DRM Function is a demand response method required by the AS/NZS 4777.2 standard and is only applicable to Australia and New Zealand.

The function is enabled by default.

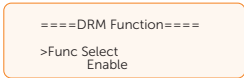

Setting Main Breaker Limit

Due to power limit, the current of Meter or CT must abide by the utility's requirements. You can set the corresponding amperage according to the utility's requirements. Failure to set the current may cause a circuit breaker fault of main switchboard, thus affecting the charging and discharging of battery.

The default value is 100 A, range: 32-100 A

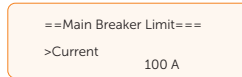

Setting Battery Heating

This function is disabled by default and is only valid when the battery has the heating function. You can enable **Battery Heating** function to make the battery heated. And set the heating period.

- a. Enable the **Battery Heating** function.

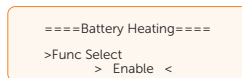

- b. Set the heating start time and end time for the battery. Two heating periods can be set.

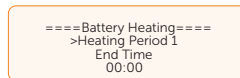

NOTICE!

- If the ambient temperature is extremely low, turning on battery heating will consume a significant amount of electrical energy.

EPS Setting

Select and enter **EPS Setting** interface and set **Frequency**, **Min SOC**, **Min ESC SOC** and **Super-Backup**.

- **Frequency:** Default: 50 Hz. Output frequency of EPS
- **Min SOC:** Default: 10%, range: 10%-25%
 - » If the battery SOC is lower than the **Min SOC**, the inverter will prompt **BatPowerLow** and turn off if there is no PV input.
- **Min ESC SoC:** Default: 20%, range: 15%-100%
 - » In EPS (Off-grid) mode, the minimum SOC required for re-entry EPS (Off-grid) mode after **BatPowerLow** prompted. When the battery SOC reaches the **Min ESC SOC** through charging from PV, the inverter will automatically enter EPS (Off-grid) mode from EPS Waiting mode.

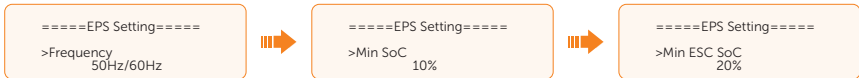

- **Super-Backup:** When the Super-Backup is enabled, if there is only PV and no battery is available, the inverter can also enter EPS (Off-grid) mode when there is a loss of grid. Default: Disable.

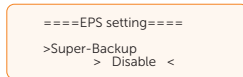

Parallel Setting

If a parallel operation is required, the user may set it with Parallel Setting.

Status shows whether the inverter is in parallel status. **Free** means the inverter is not in parallel. **Master** means the inverter has been set in parallel and has become the master inverter.

Setting means you can set the inverter's status. There are two status to choose: Free and Master.

Default: Free



Setting Extend BAT FUNC

This function allows for the extension of battery modules, such as adding a new battery module to an existing system. It is only applicable and functional in on-grid mode and cannot be used in EPS (Off-grid) mode. In on-grid mode, enabling this function will make the inverter to charge or discharge the battery SOC to approximately 38%. This function will turn to **Disable** automatically after 48 hours this function enabled.

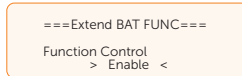

Reset

Here you can reset value of Error Log, Meter/CT, INV Energy, Wifi and INV; and restore to the factory set.

- **Reset Error Log**



- **Reset Meter/CT**



- **Reset INV Energy**



- **Factory Reset**



- **Reset Wifi**



- **INV Reset**



Setting ShutDown

ShutDown is an Enable Switch, it determines whether to allow the external switch to turn on and off the inverter. If you want to use the external switch, the Enable mode can be set.

Default: Disable

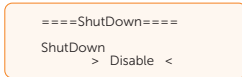

Setting MicroGrid

Here you can Enable the function of MicroGrid.

Default: Disable

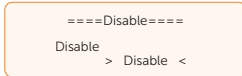

Setting ExternalGen

You can select **ATS Control** or **Dry Contact** to control ExternalGen. ExternalGen is disable by default.

Setting ATS Control to control ExternalGen

- a. Select **ExternalGen** and enter the interface, the default Disable interface will be displayed. Then press **Enter** to select **ATS Control** and enter the interface.

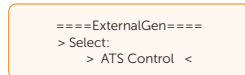
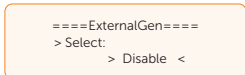

- b. After entering into the ATS Control interface, you can set **MAX Charge**, **Forced Charge Period** and **Allowed Disc Period**, **Charge from Gen** and **Gen Min Power** as follows:

- » Setting **MAX Charge**

MAX Charge means the maximum power of the generator charged to the battery.

Max Charge: Default: 3000W; range: 0~8000W

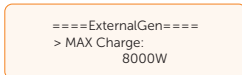

- » Setting **Forced Charge Period** and **Allowed Disc Period**

Forced Charge Period Start/End Time: Default: 00:00; range: 00:00~23:59

Allowed Disc Period Start Time: Default: 00:00; range: 00:00~23:59

Allowed Disc Period End Time: Default: 23:59; range: 00:00~23:59

Chrg&DischrgPeriod2 has the same setting logic as Forced Charge Period and Allowed Disc Period.

Forced Charge Period Start/End Time: Default: 00:00; range: 00:00~23:59

Allowed Disc Period Start/End Time: Default: 00:00; range: 00:00~23:59

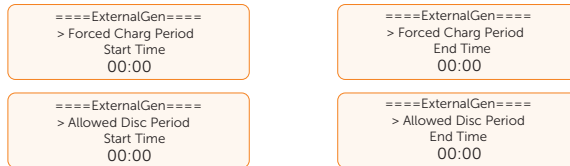

» Setting Charge from Gen

Charge battery to can only be set after Charge from Gen is enabled.

Charge battery to: Default: 30%; range: 10%~100%



» Setting Gen Min Power

Gen Min Power: Default: 0W; range: 0W~60000W

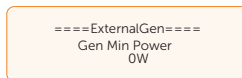

Setting Dry Contact to control ExternalGen

- a. Select **ExternalGen** and enter the interface, the default Disable interface will be displayed. Then press **Enter** to select **Dry Contact** and enter the interface.



- b. After entering into the Dry Control interface, you can set **MAX Charge**, **Start Gen Method**, **Max Run Time**, **Min Rest Time**, **Allow Work Time**, **Charge and Discharge Period** (Refer to Setting ATS Control Setting Forced Charge Period and Allowed Disc Period for details), **Charge from Gen** (Refer to Setting ATS Control Setting Charge from Gen for details) as follows:

» Setting **Max Charge**

Max Charge: Default: 3000W; range: 0~8000W

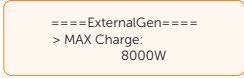

» Setting **Start Gen Method**

immediately: When the grid is disconnected from the inverter and the ExternalGen is enabled, the generator will start immediately.

reference SoC: The generator will start or close according to the Switch on/off SoC.

Switch on SoC: Default: 20%; range: 10%~100%

Switch off SoC: Default: 80%; range: 10%~100%

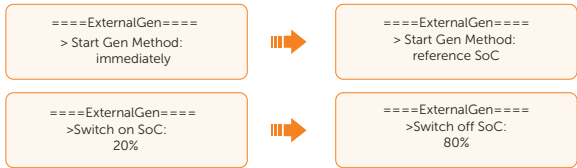

» Setting **Max. Run Time and Min. Rest Time**

Max. Run Time means the maximum time that the generator can run at a single start, and when the single start time reaches the maximum running time, the generator will actively shutdown.

Default: 1000min; range: 1~60000min

Min. Rest Time means once the generator is turned on, the generator can be turned off only after the minimum running time is reached.

Default: 60min; range: 1~60000min



» Setting **Allow Work Time**

Start Time: Default: 00:00; range: 00:00~23:59

Stop Time: Default: 23:59; range: 00:00~23:59



Setting HotStandby Setting

This function is mainly to reduce the energy losses of the system when the power of load is very low.

- **Enable:** When the power of load is very low and other conditions for entering hot standby are met, the inverter will enter **HotStandby** status to reduce system losses.
- **Disabled:** Even when the power of load is very low and other conditions for entering hot standby are met, the inverter will not enter **HotStandby** status and continue to output power to the load. It is disabled by default.

```

====HotStandby Setting====
Function Control
> Enable <
  
```

Setting Pgrid Bias

This function is disabled by default.

When the inverter has no power output:

- Check the **Meter/CT** value in **Menu>System Status>Meter/CT** when the function is disabled.
- If the **Meter/CT** displayed in **System Status** is negative value, please select **Grid** for **Pgrid Bias** to discharge power to the mains. If the **Meter/CT** displayed in **System Status** is positive value, please select **INV** for **Pgrid Bias** to take power from the mains.

```

=====Pgrid Bias=====
> Disable <
  
```

Setting Battery charger EVC

Enable means allowing the battery to discharge energy to EV Charger. **Disable** means battery discharging energy to EV Charegr is not allowed.

Default: Disable

```

====Battery charger EVC====
Battery charger EVC
> Disable <
  
```

Advanced Password

You can reset the advanced password here. When setting successfully, the LCD screen will display "Set Successfully!". While setting failed, the LCD screen will display "Setting Failed!"

10.8 About

Displaying path: **Menu > About**

Here shows the basic information of the inverter, battery, internal code. After entering the **About** interface, you can check those information.

- Inverter
 - » Inverter SN, Register SN, DSP version, ARM Verion, On-grid Run Time, EPS Run Time.
- Battery
 - » BatBrand, Bat_M SN (SN of BMS), Bat_PS1 SN (SN of battery module 1), Bat_PS2 SN (SN of battery module 2), Bat_PS3 SN (SN of battery module 3), Bat_PS4 SN (SN of battery module 4), Battery M Version (software version of BMS) and Battery S version (software version of battery module).
- Internal Code
 - » Internal code of inverter and battery.

11 Operation on SolaX App and Web

11.1 Introduction of SolaXCloud

SolaxCloud is an intelligent management platform for home energy, which integrates energy efficiency monitoring, device management, data security communication and other integrated capabilities. While managing your home energy device, it helps you optimize the efficiency of electricity consumption and improve the revenue of power generation.

11.2 Operation Guide on SolaXCloud App

11.2.1 Downloading and Installing App

Method 1: Select and scan the QR code below to download the app.



Figure 11-1 QR code for downloading SolaXCloud App

Method 2: Search for **SolaXCloud** iPhone APP Store, Google Play or Appstore of Android phones, and then download the app.

11.2.2 Operations on App

For instructions on related operations, see the Documents on the SolaXCloud App.

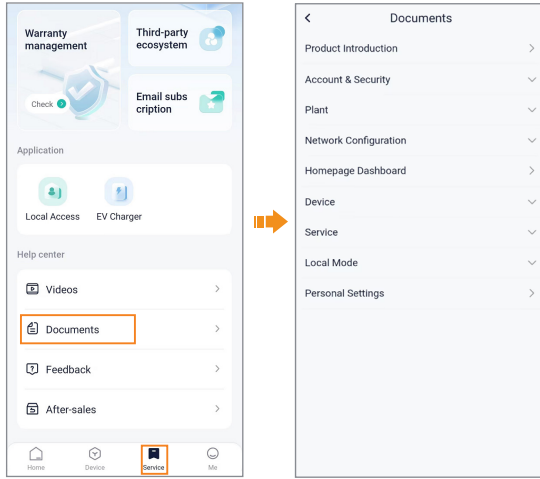

Figure 11-1 App guide on SolaXCloud

NOTICE!

- The App pages above are from the SolaXCloud App V6.0.0., which might change with version update and should be subject to the actual situations.

11.3 Operations on SolaXCloud Webpage

Open a browser and enter www.solaxcloud.com to complete registration, login, add site and other related operations according to the guidelines of User guide.

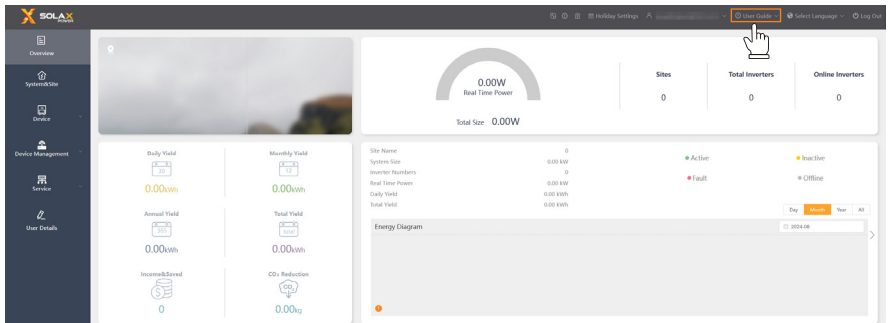

Figure 11-1 User guide on Web

12 Troubleshooting and Maintenance

12.1 Power off

- Turn off the system by **System ON/OFF** on LCD screen.
- Turn off the AC switch between the inverter and the power grid.
- Set the DC switch to **OFF**.
- Switch off the battery or the breaker, button, DC switch of the battery (see documentation of the battery manufacturer).

WARNING!

- After the inverter is powered off, there may still be residual electricity and heat which may cause electric shocks and body burns. Please wear personal protective equipment (PPE) and start maintaining the inverter at least five minutes after power off.

12.2 Troubleshooting

This section lists the possible problems with the inverter, and provides information and procedures for identifying and resolving them. In case of any errors, check for the warnings or error messages on the system control panel or App, and then refer to the suggestions below. For further assistance, contact SolaX Customer Service. Please provide the model and SN of the inverter, and be prepared to describe the system installation details.

Table 12-1 Troubleshooting list

Error Code	Fault	Diagnosis and Solutions
IE 01	TZ Protect Fault	Overcurrent fault <ul style="list-style-type: none">Wait for a while to check if it returns to normal.Disconnect PV+, PV- and batteries, reconnect.If the system is in off-grid state, check if the power of EPS loads exceeds the maximum limit of the system or exceeds the current power supply of battery.If the system fails to restore to its normal state, contact SolaX for help.
IE 02	Grid Lost Fault	Grid lost fault <ul style="list-style-type: none">Check the grid connection status.Contact SolaX for help.

Error Code	Fault	Diagnosis and Solutions
IE 03	Grid Volt Fault	<p>Power grid voltage overrun</p> <ul style="list-style-type: none"> • Wait a moment, if the utility returns to normal, the system will reconnect. • Please check if the grid voltage is within normal range. • Contact SolaX for help.
IE 04	Grid Freq Fault	<p>Grid overfrequency</p> <ul style="list-style-type: none"> • Wait a moment, if the utility returns to normal, the system reconnects. • Contact SolaX for help.
IE 05	PV Volt Fault	<p>PV overvoltage</p> <ul style="list-style-type: none"> • Check the output voltage of the PV panel. • Check if the DC switch is OFF. • Contact SolaX for help.
IE 06	Bus Volt Fault	<ul style="list-style-type: none"> • Press the ESC key to restart the inverter. • Check if the PV input open circuit voltage is in the normal range. • Check if the power of half-wave load exceeds the system limit. • Contact SolaX for help.
IE 07	Bat Volt Fault	<p>Battery voltage fault</p> <ul style="list-style-type: none"> • Check if the battery input voltage is within normal range. • Contact SolaX for help.
IE 08	AC10mins Volt	<p>Grid voltage out of range in the last 10 minutes</p> <ul style="list-style-type: none"> • The system will return to normal if the grid returns to normal. • Contact SolaX for help.
IE 09	DCI OCP Fault	<p>DCI overcurrent protection fault</p> <ul style="list-style-type: none"> • Wait for a while to check if it's back to normal. • Contact SolaX for help.
IE 10	DCV OVP Fault	<p>DCV EPS (Off-grid) overvoltage protection fault</p> <ul style="list-style-type: none"> • Wait for a while to check if it's back to normal. • Contact SolaX for help.
IE 11	SW OCP Fault	<p>Software detection of overcurrent fault</p> <ul style="list-style-type: none"> • Wait for a while to check if it's back to normal. • Shut down photovoltaic, battery and grid connections. • Contact SolaX for help.

Error Code	Fault	Diagnosis and Solutions
IE 12	RC OCP Fault	<p>Overcurrent protection fault</p> <ul style="list-style-type: none"> • Check the impedance of DC input and AC output. • Wait for a while to check if it's back to normal. • Contact SolaX for help.
IE 13	Isolation Fault	<p>Insulation fault</p> <ul style="list-style-type: none"> • Please check the wire insulation for damage. • Wait for a while to check if it's back to normal. • Contact SolaX for help.
IE 14	Temp Over Fault	<p>Temperature out of range</p> <ul style="list-style-type: none"> • Check if the ambient temperature exceeds the limit. • Contact SolaX for help.
IE 15	Bat Con Dir Fault	<p>Battery direction fault</p> <ul style="list-style-type: none"> • Check if the battery cables are connected in the opposite direction. • Contact SolaX for help if it can not return to normal.
IE 16	EPS Overload Fault	<p>EPS (Off-grid) overload fault</p> <ul style="list-style-type: none"> • Shutdown the high-power device and press the ESC key to restart the inverter. • Contact SolaX for help if it can not return to normal.
IE 17	Overload Fault	<p>On-grid mode overload fault</p> <ul style="list-style-type: none"> • Shutdown the high-power device and press the ESC key to restart the inverter. • Contact SolaX for help if it can not return to normal.
IE 18	BatPowerLow	<p>Bat power low</p> <ul style="list-style-type: none"> • Shutdown the high-power device and press the ESC key to restart the inverter. • Charge the battery to a level higher than the protection capacity or protection voltage.
IE 19	BMS Lost	<p>Battery communication lost</p> <ul style="list-style-type: none"> • Check that the communication cable between the battery and the inverter are properly connected. • Contact SolaX for help if it can not return to normal.
IE 20	Fan Fault	<p>Fan fault</p> <ul style="list-style-type: none"> • Check for any foreign matter that may have caused the fan not to function properly. • Contact SolaX for help if it can not return to normal.

Error Code	Fault	Diagnosis and Solutions
IE 21	Low TempFault	<p>Low temperature fault</p> <ul style="list-style-type: none"> • Check if the ambient temperature is too low. • Contact SolaX for help if it can not return to normal.
IE 22	ARM unmatched	<p>ARM software version mismatch fault</p> <ul style="list-style-type: none"> • Update the software and press the ESC key to restart the inverter. • Contact SolaX for help if it can not return to normal.
IE 23	Other Device Fault	<p>Other Device Fault</p> <ul style="list-style-type: none"> • Update the software and press the ESC key to restart the inverter. • Contact SolaX for help if it can not return to normal.
IE 25	InterCommsFault	<p>Internal communication fault</p> <ul style="list-style-type: none"> • Restart the inverter. • Contact SolaX for help if it can not return to normal.
IE 26	INV EEPROM	<p>Inverter EEPROM fault</p> <ul style="list-style-type: none"> • Shut down photovoltaic, battery and grid, reconnect. • Contact SolaX for help if it can not return to normal.
IE 27	RCD Fault	<p>Residual current device fault</p> <ul style="list-style-type: none"> • Check the impedance of DC input and AC output. • Disconnect PV+, PV- and batteries, reconnect. • Contact SolaX for help if it can not return to normal.
IE 28	Grid Relay Fault	<p>Electrical relay fault</p> <ul style="list-style-type: none"> • Disconnect PV+, PV-, grid and batteries and reconnect. • Contact SolaX for help if it can not return to normal.
IE 29	EPS Relay Fault	<p>EPS (Off-grid) relay fault</p> <ul style="list-style-type: none"> • Disconnect PV+, PV-, grid and batteries and reconnect. • Contact SolaX for help if it can not return to normal.
IE 30	PV ConnDirFault	<p>PV direction fault</p> <ul style="list-style-type: none"> • Check if the PV input cables are connected in the opposite direction. • Contact SolaX for help if it can not return to normal.

Error Code	Fault	Diagnosis and Solutions
IE 31	ChargeRelayFault	<p>Charge relay fault</p> <ul style="list-style-type: none"> • Press the ESC key to restart the inverter. • Contact SolaX for help if it can not return to normal.
IE 32	EarthRelayFault	<p>EPS earth relay fault</p> <ul style="list-style-type: none"> • Press the ESC key to restart the inverter. • Contact SolaX for help if it can not return to normal.
IE 101	PowerTypeFault	<p>Power type fault</p> <ul style="list-style-type: none"> • Upgrade the software and press the ESC key to restart the inverter. • Contact SolaX for help if it can not return to normal.
IE 102	Port OC Warning	<p>EPS (Off-grid) port overcurrent fault</p> <ul style="list-style-type: none"> • Check if the EPS (Off-grid) load exceeds the system requirements, and press the ESC key to restart the inverter. • Contact SolaX for help if it can not return to normal.
IE 103	Mgr EEPROM Fault	<p>Manager EEPROM fault</p> <ul style="list-style-type: none"> • Shut down photovoltaic ,battery and grid, and then reconnect. • Contact SolaX for help if it can not return to normal.
IE 104	DSPUnmatched	<p>DSP veision error</p> <ul style="list-style-type: none"> • Check that the DSP1 veision matches. • Contact SolaX for help if it can not return to normal.
IE 105	NTC Sample Invalid	<p>NTC invalid</p> <ul style="list-style-type: none"> • Make sure the NTC is properly connected and the NTC is in good condition. • Confirm that the installation environment is normal. • Contact SolaX for help if it can not return to normal.
IE 106	Bat Temp Low	<p>Battery temperature low</p> <ul style="list-style-type: none"> • Check the battery installation environment to ensure good heat dissipation. • Check if the battery heat function is enabled on the LCD screen of inverter and the heating time period is correctly set. • Contact SolaX for help if it can not return to normal.

Error Code	Fault	Diagnosis and Solutions
IE 107	Bat Temp High	Battery temperature high <ul style="list-style-type: none"> • Check the battery installation environment to ensure good heat dissipation. • Contact SolaX for help if it can not return to normal.
IE 109	Meter Fault	Meter fault <ul style="list-style-type: none"> • Check if the meter is normal and is compatible with the inverter. • Check if the communication cable is normal and properly connected. • Check if the communication settings such as protocol, address and baud rate of the meter are consistent with those of the inverter. • Contact SolaX for help if it can not return to normal.
IE 110	BypassRelayFlt	Bypass relay fault <ul style="list-style-type: none"> • Press the ESC key to restart the inverter. • Contact SolaX for help if it can not return to normal.
BE 01	BMS_Exter_Err	Battery error - external communication fault <ul style="list-style-type: none"> • Contact SolaX for help.
BE 02	BMS_InterErr	Battery error - internal communication fault <ul style="list-style-type: none"> • Contact SolaX for help.
BE 03	BMS_OverVolt	Over voltage in battery system <ul style="list-style-type: none"> • Contact SolaX for help.
BE 04	BMS_LowerVolt	Low voltage in battery system <ul style="list-style-type: none"> • Contact SolaX for help.
BE 05	BMS_ChargeOCP	Battery fault - over charge fault <ul style="list-style-type: none"> • Contact SolaX for help.
BE 06	DischargeOCP	Battery fault-discharge over current fault <ul style="list-style-type: none"> • Contact SolaX for help.
BE 07	BMS_TemHigh	Over temperature in battery system <ul style="list-style-type: none"> • Contact SolaX for help.
BE 08	BMS_TempSensor Fault	Battery temperature sensor malfunction <ul style="list-style-type: none"> • Contact SolaX for help.
BE 09	CellImblance	Battery Unbalanced Fault <ul style="list-style-type: none"> • Contact SolaX for help.
BE 10	BMS_Hardware Protect	Battery hardware protection fault <ul style="list-style-type: none"> • Contact SolaX for help.

Error Code	Fault	Diagnosis and Solutions
BE 11	BMS_Circuit	Battery circuit fault <ul style="list-style-type: none"> Restart the battery. Contact SolaX for help.
BE 12	BMS_ISO_Fault	Battery insulation fault <ul style="list-style-type: none"> Check that the battery is properly grounded and restart the battery. Contact SolaX for help.
BE 13	BMS_VolSen	Battery voltage sensor fault <ul style="list-style-type: none"> Contact SolaX for help.
BE 14	BMS_TempSen	Temperature sensor fault <ul style="list-style-type: none"> Restart the battery. Contact SolaX for help.
BE 15	BMS_CurSensor Fault	Battery current sensor fault <ul style="list-style-type: none"> Contact SolaX for help.
BE 16	BMS_Relay Fault	Battery relay fault <ul style="list-style-type: none"> Contact SolaX for help.
BE 17	BMS_Type_Unmatch	Battery type fault <ul style="list-style-type: none"> Upgrade the battery BMS software. Contact SolaX for help.
BE 18	BMS_Ver_Unmatch	Battery version mismatch fault <ul style="list-style-type: none"> Upgrade the battery BMS software. Contact SolaX for help.
BE 19	BMS_MFR_Unmatch	Battery manufacturer mismatch fault <ul style="list-style-type: none"> Upgrade the battery BMS software. Contact SolaX for help.
BE 20	BMS_SW_Unmatch	Battery hardware and software mismatch fault <ul style="list-style-type: none"> Upgrade the battery BMS software. Contact SolaX for help.
BE 21	BMS_M&S_Unmatch	Battery master slave control mismatch fault <ul style="list-style-type: none"> Upgrade the battery BMS software. Contact SolaX for help.
BE 22	BMS_CR_NORespond	Battery charging request no respond <ul style="list-style-type: none"> Upgrade the battery BMS software. Contact SolaX for help.
BE 23	BMS_SW_Protect	Battery slave software protection failure <ul style="list-style-type: none"> Upgrade the battery BMS software. Contact SolaX for help.
BE 24	BMS_536_Fault	Battery discharge over current fault <ul style="list-style-type: none"> Contact SolaX for help.

Troubleshooting and Maintenance

Error Code	Fault	Diagnosis and Solutions
BE 25	BMS_SelfCheckErr	Over temperature in battery system <ul style="list-style-type: none"> • Contact SolaX for help.
BE 26	BMS_Tempdiff	Battery temperature sensor malfunction <ul style="list-style-type: none"> • Contact SolaX for help.
BE 27	BMS_Break_Fault	Battery unbalanced fault <ul style="list-style-type: none"> • Contact SolaX for help.
BE 28	BMS_Flash_Fault	Battery hardware protection failure <ul style="list-style-type: none"> • Contact SolaX for help.
BE 29	BMS_Precharge_Fault	Battery precharge fault <ul style="list-style-type: none"> • Contact SolaX for help.
BE 30	BMS_AirSwitch_Fault	Battery air switch fault <ul style="list-style-type: none"> • Check if the battery breaker is off. • Contact SolaX for help.
/	Screen not on	<ul style="list-style-type: none"> • Check if the inverter correctly and normally connected to PV, battery or grid. • Contact SolaX for help if the inverter is connected correctly.
/	Abnormal sound on fan	<ul style="list-style-type: none"> • Check if there is foreign objects stuck in the fan. • Contact SolaX for help.
/	Screen on but no content display	<ul style="list-style-type: none"> • Contact SolaX for help.
/	No readings after CT connection	<ul style="list-style-type: none"> • Check if CT is correctly clipped on the L wire • Check if the arrow on the CT points at Grid. • Contact SolaX for help if it can not return to normal.
/	No readings on Load (on App or Web)	<ul style="list-style-type: none"> • Check if the load is connected correctly. • Check if the power of load on the LCD screen displays normally. • Check if the monitoring module works normally. • Contact SolaX for help if it can not return to normal.
/	No readings on Grid (on App or Web)	<ul style="list-style-type: none"> • Check if the grid connection is normal. • Check if the grid parameter on the LCD screen displays normally. • Check if the monitoring module works normally. • Contact SolaX for help if it can not return to normal.

Error Code	Fault	Diagnosis and Solutions
/	No readings on battery (on App or Web)	<ul style="list-style-type: none"> • Check if the battery is connected correctly. • Check if the battery parameter on the LCD screen displays normally. • Check if the monitoring module works normally. • Contact SolaX for help if it can not return to normal.
/	No Feedin data (on App or Web)	<ul style="list-style-type: none"> • Check if the meter/CT is connected correctly. • Check if the meter/CT parameter on the LCD screen displays normally. • Check if the monitoring module works normally. • Contact SolaX for help if it can not return to normal.
/	No data on App or Web	<ul style="list-style-type: none"> • Check if the monitoring module works normally. • Contact SolaX for help.
/	No display on meter after power on	<ul style="list-style-type: none"> • If the meter connection is abnormal, reconnect them according to the wiring diagrams. • Wait for the grid voltage to restore. • Contact SolaX for help if it can not return to normal.
/	Abnormal electrical data on meter	<ul style="list-style-type: none"> • If the wiring is incorrect, reconnect them based on the wiring diagrams. • Set the voltage and current ratio according to the setting steps of meter user manual. • Contact SolaX for help if it can not return to normal.

12.3 Maintenance

Regular maintenance is required for the inverter. Please check and maintain the following items based on the instructions below to ensure the optimal performance of the inverter. For inverters working in inferior conditions, more frequent maintenance is required. Please keep maintenance records.



- Only qualified person can perform the maintenance for the inverter.
- Only spare parts and accessories authorized by SolaX can be used for maintenance.

12.3.1 Maintenance routines

Table 12-2 Proposal of Maintenance

Item	Check notes	Maintenance interval
Fans	<ul style="list-style-type: none"> • Check if the fan makes noise or is covered by dust. • Clean the fan with a soft and dry cloth or brush, or replace the fan if necessary. 	Every 12 months
Electrical connection	<ul style="list-style-type: none"> • Ensure that all cables are firmly connected. • Check the integrity of the cables, ensuring that there are no scratches on the parts touching the metallic surface. • Verify that the sealing caps on idle terminals are not falling off. 	Every 12 months
Grounding reliability	<ul style="list-style-type: none"> • Check if the grounding cables are firmly connected to the grounding terminals. Use a ground resistance tester to test the grounding resistance from the inverter enclosure to the PE bar in the power distribution box. 	Every 12 months
Heat sink	<ul style="list-style-type: none"> • Check if there are foreign objects in the heat sink. 	Every 12 months
General status of inverter	<ul style="list-style-type: none"> • Check if there is any damage on the inverter. • Check if there is any abnormal sound when the inverter is running. 	Every 6 months

12.3.2 Upgrading Firmware

WARNING!

- Make sure that the type and format of the firmware file are correct. Do not modify the file name. Otherwise, the inverter may not work properly.
- Do not modify the folder name and file path where the firmware files are located, as this may cause the upgrade to fail.

WARNING!

- Before upgrading, ensure that the PV input voltage is higher than 100 V (preferably on sunny day), or that the battery SOC is higher than 20%, or the battery input voltage is higher than 90 V. Failure to meet one of these conditions may result in upgrade process failure.

Upgrade preparation

- Prepare a USB drive (USB 2.0/3.0, ≤32 GB, FAT 16/32).
- Check for the current firmware version of the inverter.
- Contact our service support for the update firmware file, and save it to the USB drive.
 - » For ARM file: 618.xxxxx.00_HYB_1P_ARM_Vx.xx_xxxxxxxx.usb
 - » For DSP file: 618.xxxxx.00_HYB_1P_DSP_Vx.xx_xxxxxxxx.usb
- Check the folder name and file path:

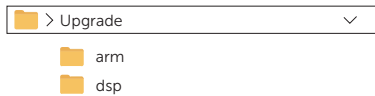
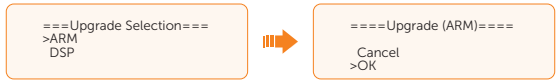

Figure 12-2 Folder name and path

Upgrade steps

- Press and hold the **Enter** key on the inverter LCD for 5 seconds to enter the **OFF** mode.
- Remove the dongle from the Dongle terminal of the inverter by hand, and then insert the USB drive. The inverter will automatically display the **Upgrade Selection** interface. (For the position of Dongle terminal, see ["8.1.1 Terminals of Inverter"](#).)
- On the **Upgrade Selection** interface, select **ARM** or **DSP** based on the file type, and then tap **OK**.



- d. Select and confirm the firmware version, and then tap the **Enter** key to start updating. ARM update takes about 20 seconds, and DSP update takes about 2 minutes.

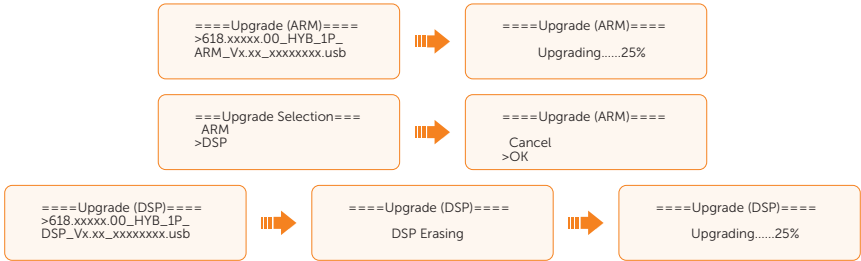

- e. After the upgrade is completed, the LCD screen displays **Upgrade Successful**. If the upgrades fail, the LCD screen displays **Upgrade failed**.

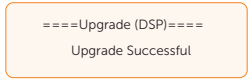

CAUTION!

- If the ARM firmware upgrade fails or stops, do not unplug the USB drive. Power off the inverter, restart it, and then repeat the above upgrade steps.

CAUTION!

If the DSP firmware upgrade fails or stops, perform operations below to troubleshoot:

- Check if the DC switch is turned off. If it is off, turn it on.
- (Recommended) If the DC switch is already on, check if the battery and PV parameters in **Menu>System Status** meets the upgrade requirements (The PV input voltage should be larger than 100 V, or the battery input voltage should be larger than 90 V, or the battery SOC be higher than 20%).
- Alternatively, select **Menu > Mode Select > Manual > Forced Charge** to charge the battery. This process can help wake up the battery for DSP upgrade.

NOTICE!

- If the LCD screen lags or freezes after the upgrade, turn off the DC switch, and then restart the inverter. Check if the inverter returns to normal. If not, contact us.

13 Decommissioning

13.1 Disassembling the Inverter



- Strictly follow the steps below to disassemble the inverter.
- Only use the disassembling tool for PV terminal delivered with the inverter to disassemble the PV connector

Step 1: Turn off the system by **System ON/OFF** on LCD screen.

Step 2: Disconnect the external AC breaker of the inverter.

Step 3: Turn the DC switch to OFF.

Step 4: Turn off the battery switch / button / breaker (if any). (See documents of battery)

Step 5: Disconnect the PV connectors: Insert the disassembling tool for PV terminal into the notch of PV connectors and slightly pull out the connectors.

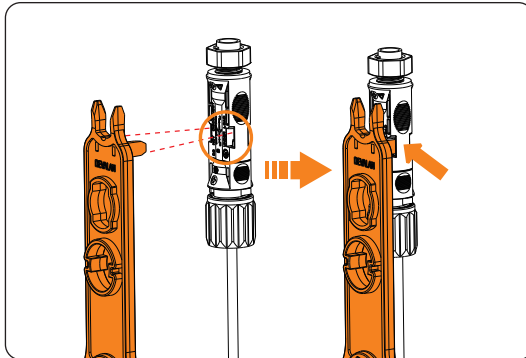

Figure 13-3 Removing the PV connector

Step 6: (Optional) Disassembling the dustproof buckles: use disassembling tool for PV terminal to disassemble the dustproof buckles as shown below.

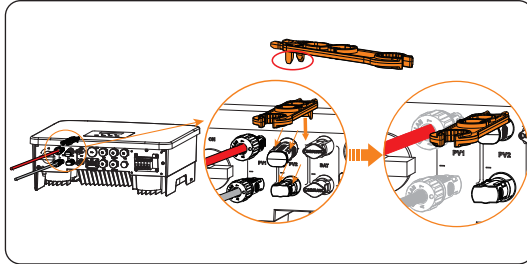

Figure 13-4 Disassembling the dustproof buckles

Step 7: Slightly pull out the dongle module.

Step 8: Disconnect the battery connectors: Insert the flat-head screwdriver into the notch of connectors and slightly pull the connectors.

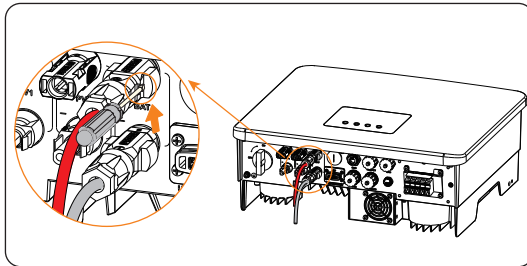

Figure 13-5 Removing the battery connector

Step 9: Disconnect the AC connector: Loosen the swivel nuts, and then loosen the screws on the AC terminal. Loosen the terminal block screws of L, N, and the grounding on the terminal block. Slight pull the connectors.

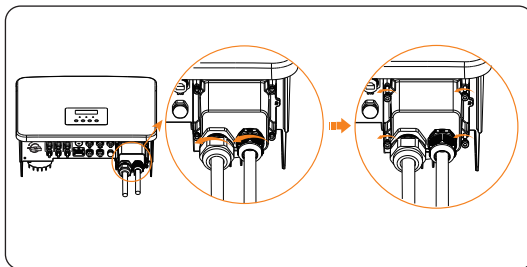

Figure 13-6 Loosening the swivel nuts

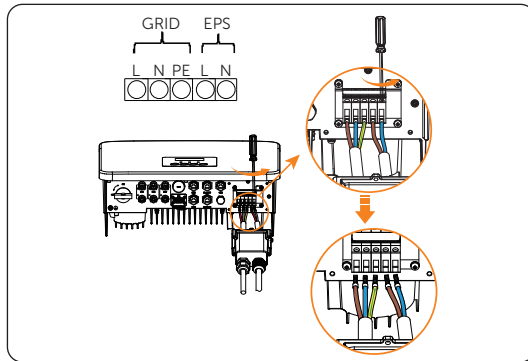

Figure 13-7 Removing AC connector

- Step 10:** Disconnect the COM connector: Loosen the swivel nut of the BMS, CAN, COM/LCD, DRM and Meter/CT ports, then slightly pull out the RJ45 terminals.
- Step 11:** Put the original terminal caps on the terminals.
- Step 12:** Unscrew the grounding screw by philips head screw and remove the grounding cable.
- Step 13:** Unlock the anti-theft lock if you installed it. Unscrew the M5 screw on the sides of inverter and vertically lift up the inverter to dismantle the inverter.

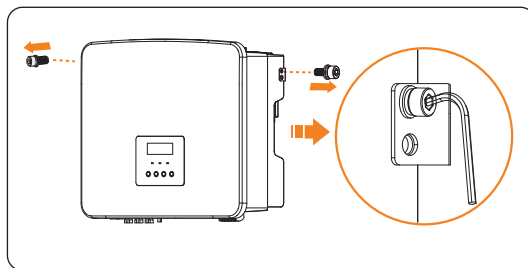

Figure 13-8 Unscrewing the M5 screws

- Step 14:** Unscrew the screws for fastening the wall mounting bracket and remove the wall mounting bracket if needed.

13.2 Packing the Inverter

- Use the original packaging materials if available.

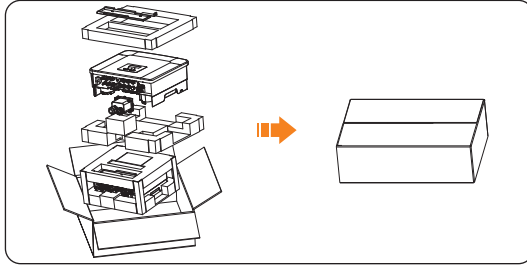

Figure 13-9 Packing the inverter

- If the original packing material is not available, use the packing material which meets the following requirements:
 - » Suitable for the weight and dimension of product
 - » Convenient for transportation
 - » Can be sealed with adhesive tape

13.3 Disposing of the Inverter

Properly dispose of the inverter and accessories in accordance with local regulations on the disposal of electronic waste.

14 Technical Data

- PV Input (apply to version D/M)

Model	X1-Hybrid-3.0	X1-Hybrid-3.7	X1-Hybrid-5.0 X1-Hybrid-5.0K-D	X1-Hybrid-6.0	X1-Hybrid-7.5
Max. recommended PV power ¹ [W]	6000	7400	10000	12000	15000
Max PV voltage [d.c. V]	600	600	600	600	600
Nominal DC operating voltage [d.c. V]	360	360	360	360	360
MPPT voltage range [d.c. V]	70-550				
MPPT full power voltage range [d.c. V]	115-480	135-480	190-480	225-480	280-480
Max. PV current [d.c. A]	16/16	16/16	16/16	16/16	16/16
Isc PV array short circuit [d.c. A]	20/20	20/20	20/20	20/20	20/20
Start output voltage [d.c. V]	90	90	90	90	90
Max. inverter backfeed current to the array [d.c. V]	0	0	0	0	0
No. of MPP trackers	2	2	2	2	2
Strings per MPP trackers	1	1	1	1	1

* Marked with "1" indicates that a single channel MPPT can only input a maximum of 5000W.

* The specific gross weight is subject to the actual situation of the whole machine, which may be a little different due to the influence of the external environment.

- AC Output (On-grid) (apply to version D/M)

Model	X1-Hybrid-3.0	X1-Hybrid-3.7	X1-Hybrid-5.0 X1-Hybrid-5.0K-D	X1-Hybrid-6.0	X1-Hybrid-7.5
Rated output apparent power [VA]	3000	3680	5000 (Germany 4600, AU 4999) (5.0K-D 4999)	6000	7500 (PEA 6900)
Max. output apparent power [VA]	3300	3680	5500 (Germany 4600, AU 4999) (5.0K-D 4999)	6600	7500 (PEA 7300)
Nominal AC voltage [a.c. V]	220/230/240				
Frequency [Hz]	50/60				
Rated output current [a.c. A]	13	16	21.7	26.1	32.6
Max. output continuous current [a.c. A]	14.4	16	23.9 (Germany 20, AU 21.7)	28.6	32.6 (PEA 33)
Current (inrush) (at 50μs) [a.c. A]	10				
Maximum output fault current (at 1ms) [a.c. A]	91				
Maximum output overcurrent protection [a.c. A]	65				
Power factor range	0.8 leading - 0.8 lagging				
Total harmonic distortion (THDi)	< 2%				

Technical Data

- AC Input (apply to version D/M)

Model	X1-Hybrid-3.0	X1-Hybrid-3.7	X1-Hybrid-5.0 X1-Hybrid-5.0K-D	X1-Hybrid-6.0	X1-Hybrid-7.5
AC input					
Max. apparent power [VA]	6300	7360	9200	9200	9200
Rated AC power [W]	3000	3680	5000	6000	7500
Nominal AC voltage [a.c. V]	220/230/240				
Frequency [Hz]	50/60				
Max. AC input current [a.c. A]	27.4	32	40	40	40
Power factor range	0.8 leading - 0.8 lagging				

- Battery (apply to version D/M)

Model	X1-Hybrid-3.0	X1-Hybrid-3.7	X1-Hybrid-5.0 X1-Hybrid-5.0K-D	X1-Hybrid-6.0	X1-Hybrid-7.5
Battery type	Lithium-ion battery / Lead-acid battery				
Battery voltage range [d.c. V]	80-480				
Max. continuous charge/ discharge current [d.c. A]	30				
Communication interface	CAN/RS485				
Reverse connection protection	Yes				

- EPS Output (apply to version D/M)

Model	X1-Hybrid-3.0	X1-Hybrid-3.7	X1-Hybrid-5.0 X1-Hybrid-5.0K-D	X1-Hybrid-6.0	X1-Hybrid-7.5
Rated EPS apparent power [VA]	3000	3680	5000	6000	7500
Nominal EPS voltage [a.c. V]	230				
Frequency	50/60				
Rated EPS current [a.c. A]	13	16	21.7	26.1	32.6
EPS (Off-grid) peak power [VA]	6000, 10s	6000, 10s	7500, 10s	9000, 10s	11250, 10s
Switching time (typical value) [ms]	< 10				
Total harmonic distortion (THDv)	< 2 %				

• Efficiency, Safety and Protection (apply to version D/M)

Model	X1-Hybrid-3.0	X1-Hybrid-3.7	X1-Hybrid-5.0 X1-Hybrid-5.0K-D	X1-Hybrid-6.0	X1-Hybrid-7.5
Efficiency					
MPPT efficiency	99.9%	99.9%	99.9%	99.9%	99.9%
European efficiency	97.0%	97.0%	97.0%	97.0%	97.0%
Maximum efficiency	97.6%	97.6%	97.6%	97.6%	97.6%
Max. battery charge efficiency (PV to BAT) (@ full load)	97.0%	97.0%	97.0%	97.0%	97.0%
Max. battery discharge efficiency (BAT to AC) (@ full load)	97.0%	97.0%	97.0%	97.0%	97.0%
Safety and Protection					
Safety	IEC/EN 62109-1/-2				
Grid monitoring	VDE-AR-N 4105, G99, G98, AS/NZS 4777, EN50549, CEI 0-21, C10/11, IEC61727, RD1699, NRS 097-2-1, PEA/MEA, VFR2019, PPDS				
DC SPD protection	Integrated				
AC SPD protection	Integrated				
Over/ under voltage protection	Yes				
Grid protection	Yes				
DC injection monitoring	Yes				
Back feed current monitoring	Yes				
Residual current detection	Yes				
Active anti-islanding method	Frequency Shift				
Over load protection	Yes				
Over heat protection	Yes				
Array insulation resistance detection	Yes				

Technical Data

- General Data (apply to version D/M)

Model	X1-Hybrid-3.0	X1-Hybrid-3.7	X1-Hybrid-5.0 X1-Hybrid-5.0K-D	X1-Hybrid-6.0	X1-Hybrid-7.5
Dimensions (W/H/D) [mm]	482*417*181				
Dimensions of packing (W/H/D) [mm]	590*530*315				
Net weight [kg]	24	24	24	24	25
Gross weight * [kg]	28	28	28	28	29
Heat dissipation treatment	Natural cooling			Smart cooling	
Noise emission (typical) [dB]	< 30			< 45	
Storage temperature range [°C]	-40 to +65				
Operating ambient temperature range [°C]	-35 to +60 (derating at 45)				
Humidity [%]	4 ~ 100 (Condensing)				
Altitude [m]	< 3000				
Ingress protection	IP65				
Protective class	I				
Cold standby consumption	< 3W				
Overvoltage category	III(MAINS), II(PV, Battery)				
Pollution degree	III				
Installation mode	Wall mounted				
Inverter topology	Non-isolated				
Communication interface	Meter/CT, external control RS485, Pocket WiFi (optional: Pocket Lan / 4G), DRM, USB Upgrade, NTC (optional)				

* The specific gross weight is subject to the actual situation of the whole machine, which may be a little different due to the influence of the external environment.

15 Appendix

15.1 Application of Generator

15.1.1 Introduction of generator application

When utility power supply is unavailable, the system can seamlessly switch to the generator for power supply and continue the collaboration with the energy storage system to ensure the uninterrupted operation of the load.

In this case, the generator functions as the utility grid to supply power for the load, and the hybrid inverter converts the solar energy to electricity.

15.1.2 Notice for generator application

- Note 1: The generator should be equipped with an Auto Transformer Switch (ATS), enabling it to start automatically in the event of a power outage.
- Note 2: The rated output power of the generator should be greater than the sum of the load power and the battery charging power. If there are two inverters in parallel, the rated output power of the generator should be greater than the sum of the load power and the battery charging power of the two inverters.
- Note 3: If the rated output power of the generator is small and cannot meet the requirements of Note 2, the setting value of **MaxChargePower** can be changed in the **Menu>Setting>Advance Setting>ExternalGen** to ensure that the generator power can meet the load and battery charging use at the same time.
- Note 4: The EPS load power cannot be greater than the battery discharge power to prevent the battery power from being unable to meet the EPS load after the generator shuts down and the inverter will report an **Overload fault** alarm. If two inverters are paralleled, the EPS load power shall be doubled.

15.1.3 ATS control mode

In this operating mode, the generator functions as a substitute for the grid. There is no communication between the generator and the inverter, which means no wiring modifications are required (although the inverter cannot control the generator, either). The ATS working for the generator determines whether the generator should be turned on or off based on the status of the grid.

Wiring connection diagram

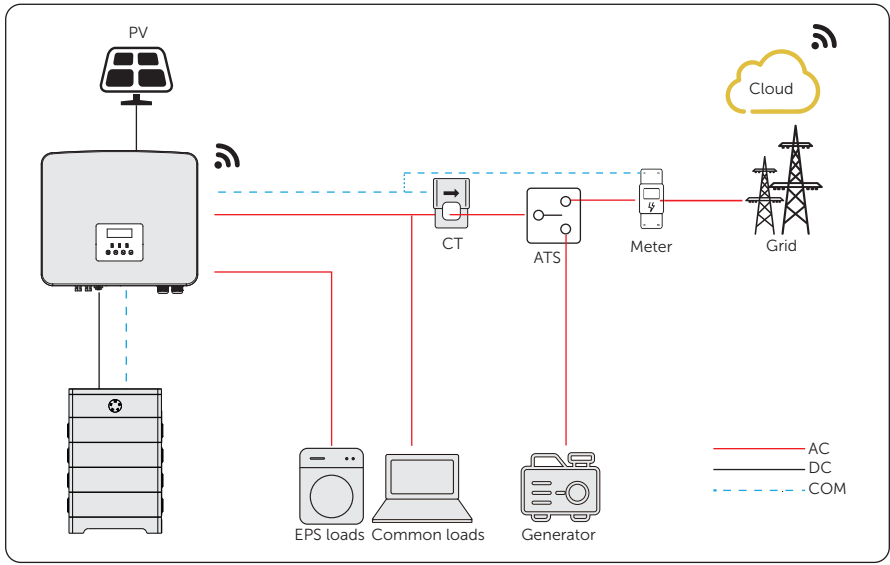
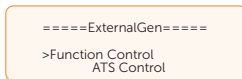

Figure 15-1 ATS control wiring diagram

Inverter settings for ATS control mode

- a. Select **Menu>Setting>Advance Setting>ExternalGen>ATS Control**.



- b. Set the relative parameters as below in accordance with actual needs.

- » **MaxCharge:** Maximum battery charging power from generator. (0-8000 W, 3000 W by default)

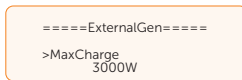

- » **Char&Disc Period:** Including **Forced Charge Period** and **Allowed Disc Period**. Two periods can be set. These period settings are associated with the same settings under **Working mode** for no need to jump to working mode page to set the working period when using generator mode.

```

=====ExternalGen=====
>Forced Chrg Period
  Start Time
  00:00
=====ExternalGen=====
>Allowed Disc Period
  Start Time
  00:00

=====ExternalGen=====
>Forced Chrg Period
  End Time
  00:00
=====ExternalGen=====
>Allowed Disc Period
  End Time
  00:00
    
```

- » **Charge from Gen and Charge battery to:** The SOC which allows the system charging from generator. (10-100%, 30% by default)

15.1.4 Dry contact mode

In this operating mode, users can intelligently control the system by establishing a dry contact connection between the inverter and the generator. It allows for adjustments to multiple settings so that the system can meet the requirements of different scenarios.

Wiring connection diagram

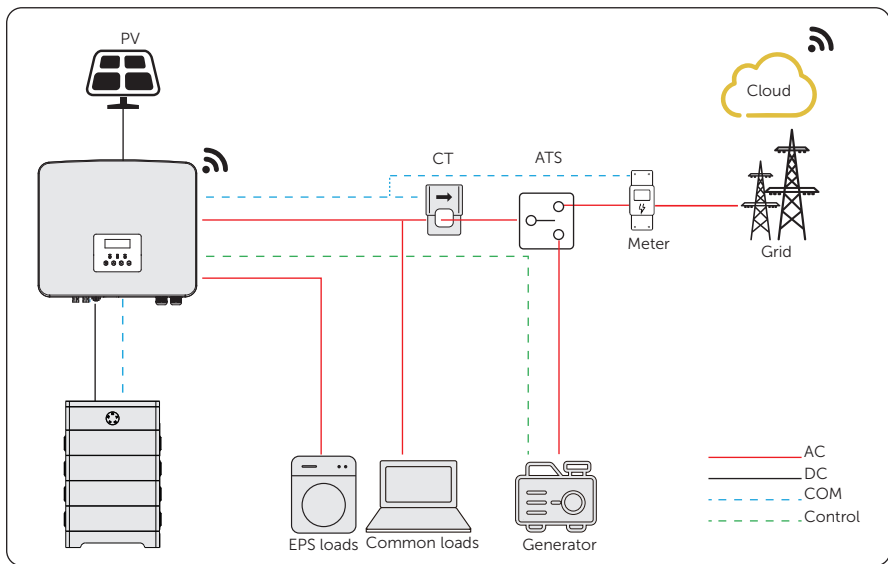

Figure 15-2 Dry contact wiring diagram

Inverter connection for dry contact mode

- Connection terminal-COM/LCD terminal

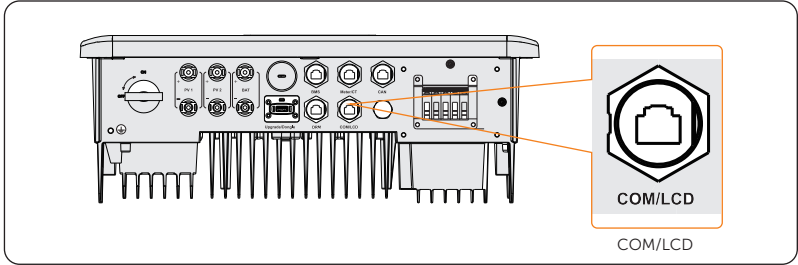

Figure 15-3 Connection terminal for generator

- Connection pins-Pin 7 and Pin 8

Table 15-1 Connection pins for generator

Application	/		Power	Communication			/		Generator
Pin	1	2	3	4	5	6	7	8	
Assignment	DI_1	DI_2	ARM_ POWER	REMOTE_ 485A	REMOTE_ 485B	GND_ COM	DO_1	DO_2	

- Inverter settings for dry contact mode
 - Select **Menu>Setting>Advance Setting>ExternalGen>Dry Contact.**



- Set the relative parameters in accordance with actual needs.

- » **MaxCharge:** Maximum battery charging power from generator. (0-8000 W, 3000 W by default).

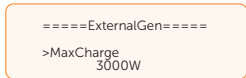

- » **Start Gen Method:** Reference SOC and Immediately can be selected.
 - Reference SOC:** Turn on/off generator according to the set **Switch on/off SOC.**
 - Immediately:** Turn on /off the generator when grid status changed.

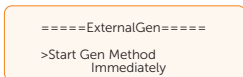
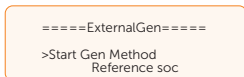

- » **Switch on/off SOC:** the option is activated when you select **Reference SOC** for **Start Gen Method**. The inverter will turn on the generator when the battery reaches the set **Switch on SOC** and turn it off when the battery reaches the set **Switch off SOC**.



- » **MaxRunTime:** Maximum operating time of generator. (1000 Min by default)

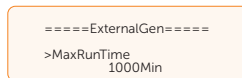

- » **MinRestTime:** Minimum time interval for two consecutive starts to avoid frequent generator on and off.

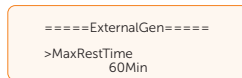

- » **Charge&Disc Period:** Including **Forced Charge Period** and **Allowed Disc Period**. Two periods can be set. These period settings are associated with the same settings under **Working mode** for no need to jump to working mode page to set the working period when using generator mode.

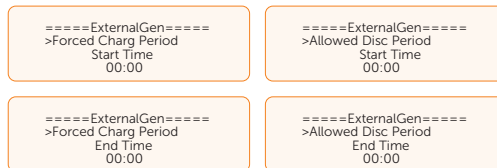

- » **Allow Work:** Allowed time period for generator operating. You can set the start time and end time.



- » **Charge from Gen and Charge battery to:** The SOC which allows the system charging from generator. (10-100% from generator, 30% by default)



15.2 Application of Adapter Box G2

15.2.1 Introduction of Adapter Box G2 application

With the SolaX Adapter Box G2, users can effectively utilize solar energy by commanding it to power their heat pump using settings available on the SolaX inverter and SolaXCloud. This intelligent integration allows for optimized solar self-consumption and ultimately helps in reducing electricity bills.

15.2.2 Wiring connection diagram

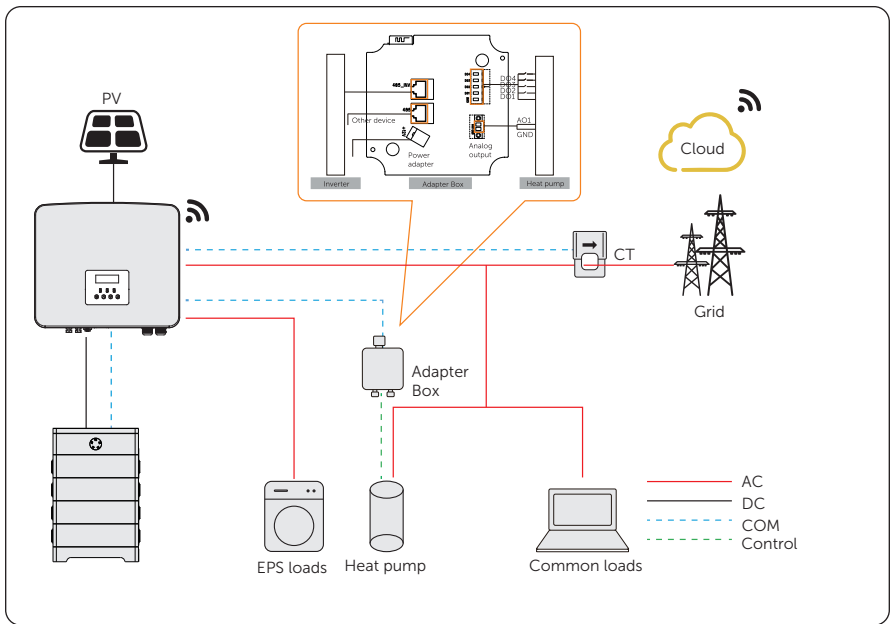

Figure 15-4 Adapter Box G2 wiring diagram

The inverter communicates with Adapter Box G2 via COM/LCD. In case of excess power, the Adapter Box G2 can utilize it to heat the pump through the connection of dry contacts, SG Ready, or Analog output between the Adapter Box G2 and the heat pump. To power the Adapter Box G2, an external power adapter is required as the inverter itself cannot supply power to the Adapter Box G2.

15.2.3 Communication connection with inverter

- Connection terminal-COM/LCD terminal

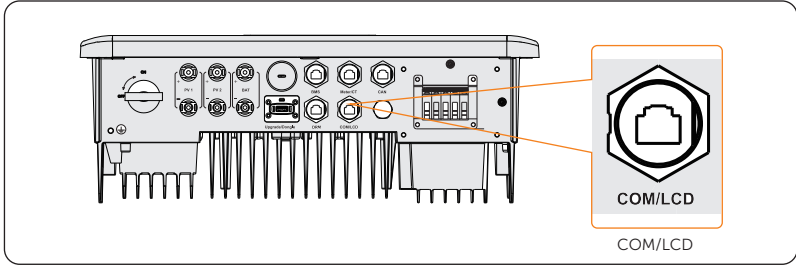

Figure 15-5 Connection terminal for Adapter Box G2

- Connection pins

Table 15-2 Pin-to-pin connection for inverter and Adapter Box G2

COM/LCD terminal of inverter		RS485_INV terminal of Adapter Box G2	
Pin	Pin assignment	Pin	Pin assignment
4	REMOTE_485A	4	RS485-A
5	REMOTE_485B	5	RS485-B

- Connection steps-Please refer to "8.6.4 RS485 Communication Connection" for specific wire making and connection.

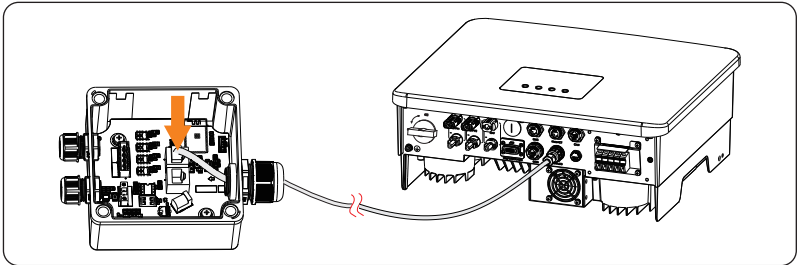

Figure 15-6 Connecting to Adapter Box

NOTICE!

- The communication cable between Adapter Box G2 and inverter can not exceed 100m.

15.2.4 Settings for Adapter Box G2

- a. Select **Menu>Setting>Advance Setting>Modbus**;
- b. Select the **AdapBoxG2** and set the **Baud Rate** and corresponding Address. The default **Baud Rate** is 9600.

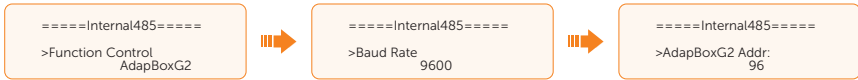

NOTICE!

- When two equipments need to be connected at the same time, the baud rate and address of the two equipments shall be set to the same.

- c. Check the connection status.

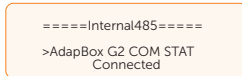

NOTICE!

- For specific wiring and setting procedures of Adapter Box G2, see *Adapter Box G2 User Manual*.

15.3 Application of EV-Charger

15.3.1 Introduction of EV-Charger application

The EV-Charger is intended for charging electric vehicles. It should be installed in a fixed location and connected to the AC supply. The EV-Charger can communicate with other devices or systems (inverter, meter, CT, third-party charger management platform, etc.) to realize intelligent control of charging process.

15.3.2 Wiring connection diagram

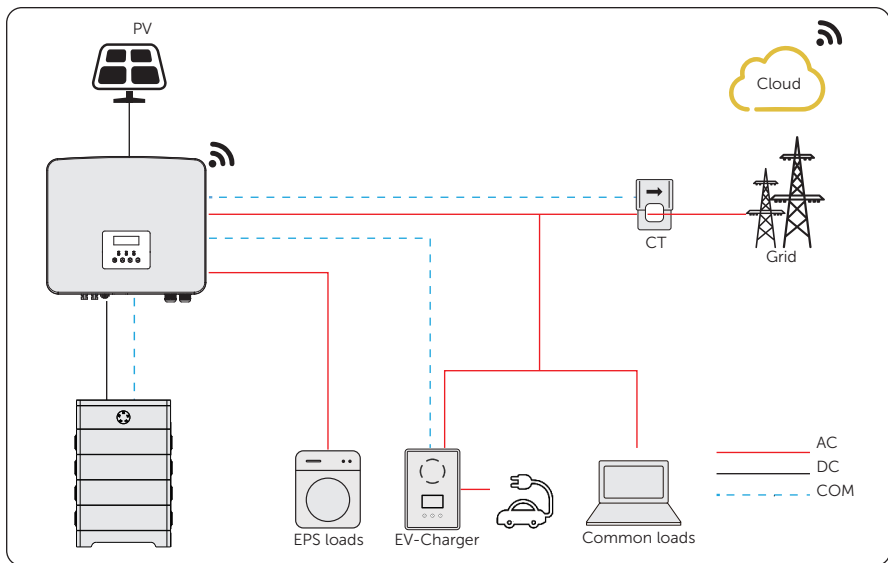

Figure 15-7 EV-Charger wiring diagram

15.3.3 Communication connection with inverter

- Connection terminal-COM/LCD terminal

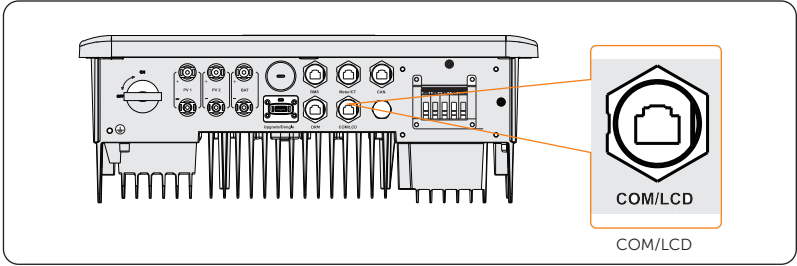

Figure 15-8 Connection terminal for EV-Charger

- Connection pins

Table 15-3 Pin-to-pin connection for inverter and EV-Charger

COM/LCD terminal of inverter		COM terminal of EV-Charger	
Pin	Pin assignment	Pin	Pin assignment
4	REMOTE_485A	5	B1
5	REMOTE_485B	4	A1

- Connection steps-Please refer to "8.6.4 RS485 Communication Connection" for specific wire making and connection.

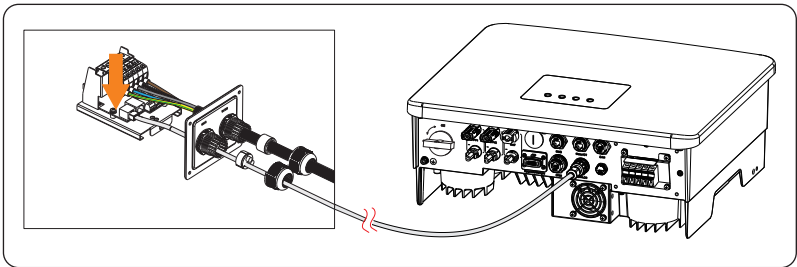

Figure 15-9 Connecting to EV-Charger

NOTICE!

- The communication cable between EV-Charger and inverter can not exceed 100m.

15.3.4 Setting for EV-Charger

- Select **Menu>Setting>Advance Setting>Modbus**;
- Select the **EV Charger** and set the **Baud Rate** and corresponding Address. The default **Baud Rate** is 9600.

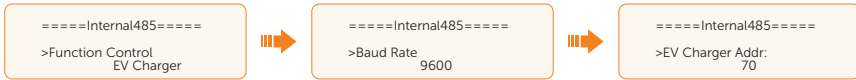

NOTICE!

- When two equipments need to be connected at the same time, the baud rate and address of the two equipments shall be set to the same.

- Check the connection status.



- You can enable **Battery Charge EVC** to allow the battery to discharge energy to EV-Charger through setting path: **Menu>Setting>Advance Setting>Battery Charge EVC**.

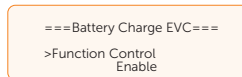

NOTICE!

- For specific wiring and setting procedures of EV-Charger, see *X1-EVC Series User Manual*.

15.4 Application of DataHub

15.4.1 Introduction of DataHub application

SolaX DataHub can be connected to inverters through COM/LCD to control the output power of the entire power station according to on-site requirements. Besides, it can work with SolaXCloud to monitor all inverters, allowing for real-time data display and device management. In the entire system, a maximum of 60 X1-Hybrid G4 series inverters can be connected to the DataHub.

15.4.2 Wiring connection diagram

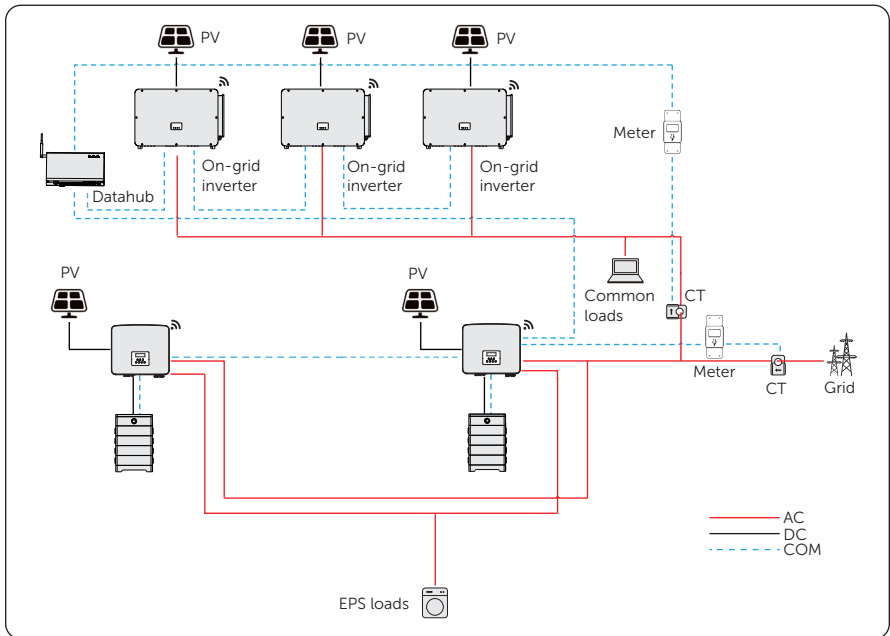

Figure 15-10 DataHub wiring diagram

15.4.3 Communication connection with inverter

- Connection terminal-COM/LCD terminal

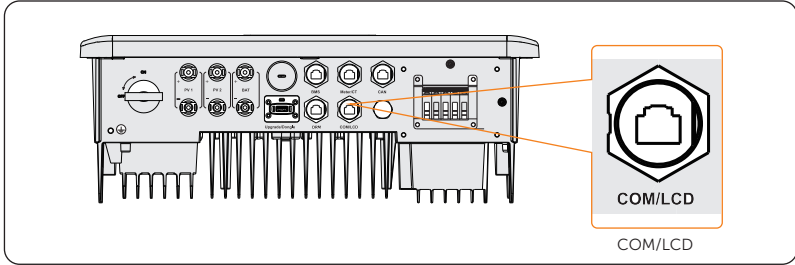

Figure 15-11 Connecting terminal for DataHub

- Connection pins

Table 15-4 Pin-to-pin connection for inverter and DataHub

COM/LCD terminal of inverter		RS485-1 terminal of DataHub	
Pin	Pin assignment	Pin	Pin assignment
4	REMOTE_485A	/	A+
5	REMOTE_485B	/	B-

- Connection steps-Please refer to "8.6.4 RS485 Communication Connection" for specific wire making and connection.

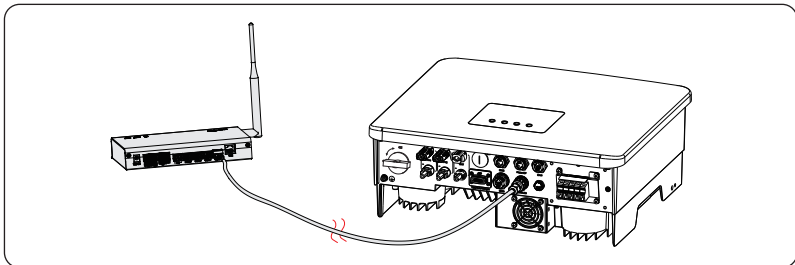

Figure 15-12 Connecting to DataHub

NOTICE!

- The communication cable between DataHub and inverter can not exceed 100m.

15.4.4 Settings for DataHub

- a. Select **Menu>Setting>Advance Setting>Modbus**;
- b. Select the **DataHub** and set the **Baud Rate** and corresponding Address.

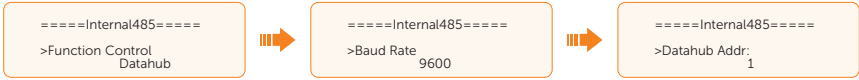

NOTICE!

- The baud rate, communication protocol and verification method of the inverters connected to the same RS485 terminal of DataHub must be consistent, and the communication addresses of the inverters must be consecutive and not repeated.

NOTICE!

- For specific wiring and setting procedures of DataHub, see *DataHub 1000 User Manual*.

15.5 Application of Micro-grid

15.5.1 Introduction of Micro-grid application

Due to Islanding Effect, on-grid inverter is unable to work during off-grid. This characteristic makes user losing the on-grid inverter PV energy when off-grid. Micro-grid is the function that making hybrid inverter simulate the grid to active on-grid inverter during off-grid by connecting on-grid inverter to hybrid inverter's EPS terminal.

15.5.2 Wiring connection diagram

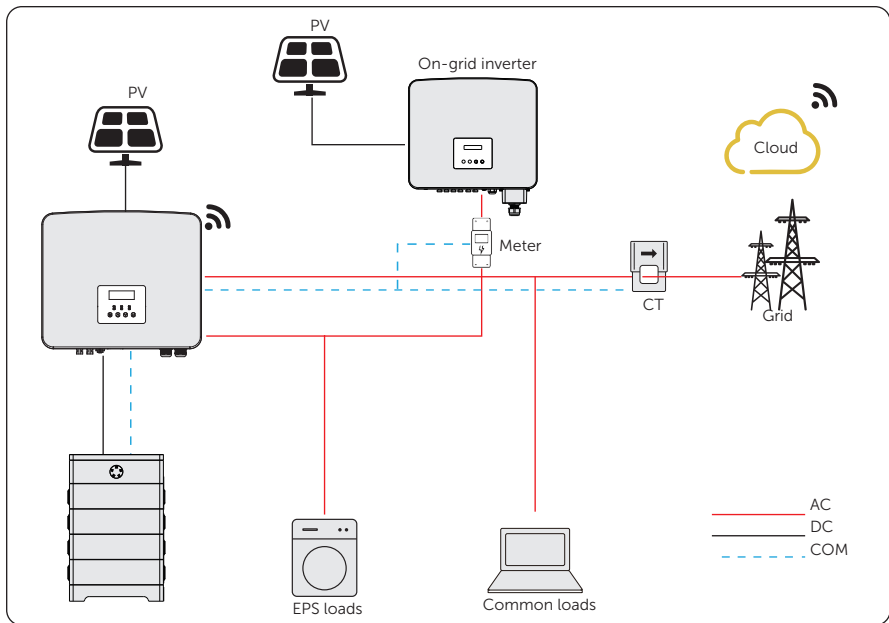

Figure 15-13 Micro-grid wiring connection

15.5.3 Working modes

Grid on

- When PV is sufficient, the hybrid and on-grid inverters power the common and EPS loads together. When there is surplus energy on the on-grid inverter, it will also charge the battery.
- When PV is insufficient, the hybrid, on-grid inverter and grid power all the loads.

Grid off

In this case, the hybrid inverter will simulate the grid so as to make the on-grid inverter work. Hybrid and on-grid inverter will power the EPS loads together. If there is surplus energy, it will charge the battery.

NOTICE!

- In EPS mode, due to limited battery charging power, the hybrid inverter will increase the EPS output frequency to restrict and shut down the on-grid inverter, ensuring the stable operation of the entire system. In this period, the on-grid inverter may report a **Grid frequency Fault** which is a normal phenomenon.

Notice for micro-grid application

- Any brand of on-grid inverter that supports "frequency adaptation"
- On-grid inverter output power \leq Max hybrid inverter EPS output power
- On-grid inverter output power \leq Max battery charging power

NOTICE!

- Since X1-Hybrid G4 series inverter is unable to control the output power of on-grid inverter in grid connection mode, the series inverter can not achieve zero export when loads power + battery charging power < on-grid inverter output power.

15.5.4 Cable connection (Hybrid inverter)

Please refer to "[8.3 AC Connection](#)" for Grid and EPS connection on X1-Hybrid G4 series inverter.

15.5.5 Cable connection (On-grid inverter)

Please connect the AC cable of on-grid inverter to the EPS terminal of X1-Hybrid G4 series inverter. Please refer to the user manual of specific on-grid inverter.

15.6 Application of Parallel Function

15.6.1 Introduction of parallel application

The series inverters supports parallel operation in both Grid and EPS modes. It supports up to 2 units in the parallel system.

15.6.2 Notice for parallel application

- The two inverters should be of the same software version.
- For optimal efficiency, it is recommended that the two inverters have the same model, and are connected to batteries of the same model and quantity.
- In parallel system, there are three status: **Free**, **Slave** and **Master**.

Table 15-5 Three status

Free	Only if no one inverter is set as a Master , the two inverters are in Free mode in the system.
Slave	Once one inverter is set as a Master , the other inverter will enter Slave mode automatically. Slave mode can not be changed from other modes by LCD setting.
Master	When one inverter is set as a Master , this inverter enters Master mode. Master mode can be changed to Free mode.

- Master inverter has an absolute lead in the parallel system to control the other slave inverter's energy management and dispatch control. Once master inverter has some error and stop working, the other slave inverter will be stop simultaneously. But master inverter is independent of the slave inverter to work and will not be affected by slave inverter's fault.
- Overall system will be running according to master inverter's setting parameters, and most setting parameters of slave inverter will be kept but not be cancelled.
- Once slave inverter exits from the system and be running as an independent unit (the network cable is disconnected simultaneously), its all setting will be re-activated.
- The parallel system is extremely complex and requires a large number of cables to be connected. Therefore, the cables must be connected in the correct wire sequence. Otherwise, any small mistake can lead to system failure.
- The communication cable length should not exceed 10 m.

15.6.3 System wiring diagram

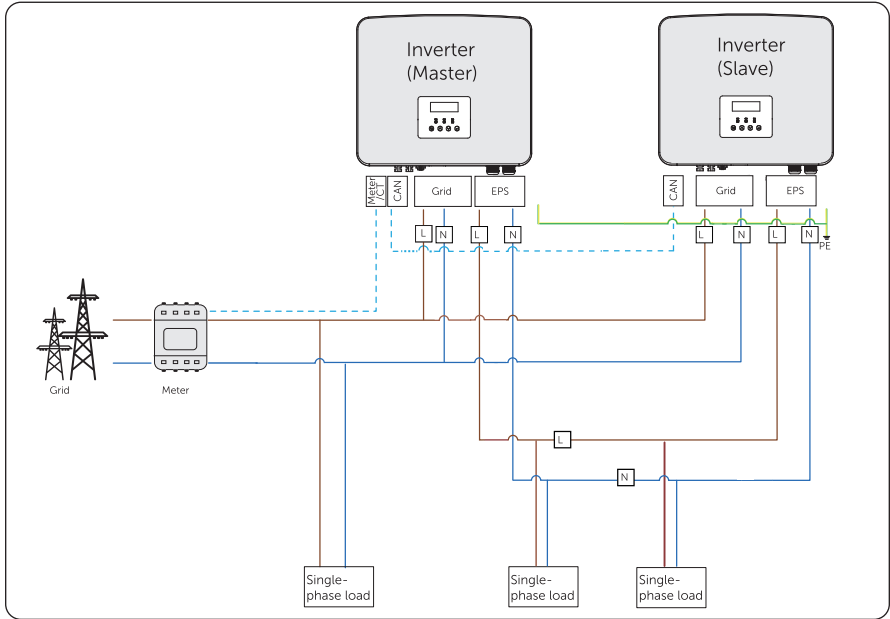

Figure 15-14 System wiring diagram

15.6.4 System wiring procedure

Power cable wiring-Grid and EPS terminal

- Grid terminal of Master and Slave inverter: L connects to L and N connects to N,
- EPS terminal of Master and Slave inverter: L connects to L and N connects to N,
- PE cable connects to the E-BAR nearby.

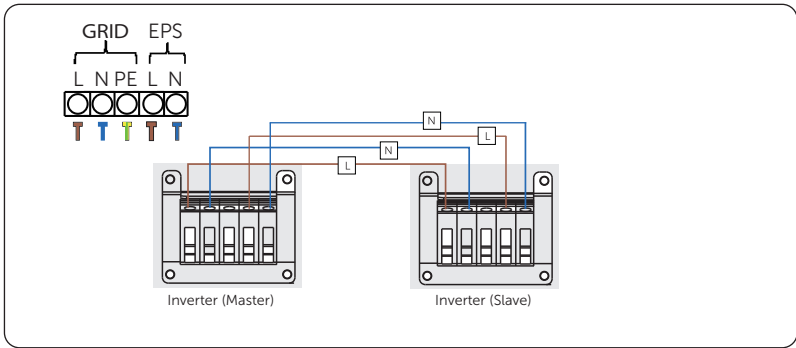

Figure 15-15 Power cable wiring

Communication cable wiring-CAN terminal and Meter/CT terminal

- Use standard network cables for Master-Slave inverter connection.
- Master inverter CAN connects to Slave inverter CAN.
- Meter/CT connects to Meter/CT terminal of the Master inverter. Please refer to "8.7.2 Meter/CT Connection".

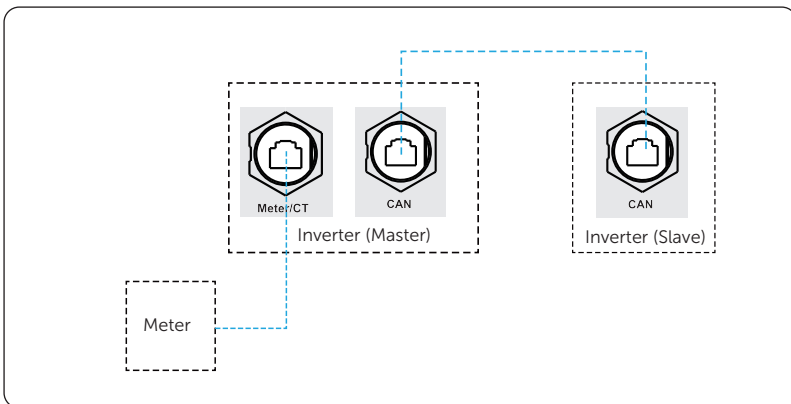

Figure 15-16 Communication wiring

NOTICE!

- For details on the specific wiring of the inverter, see "8.3 AC Connection" and "8.6.2 Parallel Connection".

15.6.5 Settings for parallel connection

Parallel setting

Setting path: **Menu>Setting>Advance Setting>Parallel Setting.**

How to build the parallel connection

- a. Turn on the power of the entire system, find the inverter which needs to be set as Master and connect the meter to Master inverter, enter the setting page of the Master inverter LCD screen, select the **Parallel Setting**, and select **Master**; then enter the **Resistance Switch** and set it to **ON**;

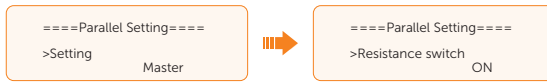

- b. Find the last slave in the parallel system and enter the setting page of the inverter LCD screen and set the **Resistance Switch** to **ON**.

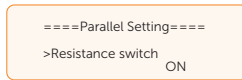

How to remove the parallel connection

- a. Find the inverter which needs to be set as Free. Select the **Parallel Settings** and select **Free** for the inverter.

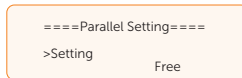

- b. Disconnect all the network cables on the Parallel-1 and Parallel-2 port.

NOTICE!

- If a slave inverter is set to **Free** mode but not disconnect the network cable, this inverter will return to **Slave** mode automatically.
- If a slave inverter is disconnected with master inverter but not be set to **Free** mode, this slave inverter will stop working and prompt **ParallelFault**.

Parallel display

Displaying path: **Menu>Parallel Status**

NOTICE!

- Once inverter enters parallel system, the **Today** yield will be replaced by **Parallel**.

In **Parallel Status** interface, the number displayed in the **Parallel Status** interface refers to the total number of online inverters, for example two inverters in parallel in the below figure.



15.7 Application of Meter/CT

15.7.1 CT/Meter Connection Scenarios

X1-Hybrid G4 inverter series can be connected to a CT, a direct-connected meter, or a CT-connected meter. It also supports a Meter 2 function for you to monitor another power generation equipment at home.

Followings are the detailed wiring and setting procedures of these scenarios. For wiring procedure of the inverter CT/Meter port, see "8.6.3 **Meter/CT Wiring procedure**".

15.7.2 Connection of CT

NOTICE!

- Do not place the CT on the N wire or ground wire.
- Do not place CT on the N line and L line at the same time.
- Do not place the CT on non-insulated wires.
- The cable length between CT and inverter should not exceed 100 meters.
- After CT is connected, prevent the CT clip from falling off. It is recommended to wrap the CT clip around in circles with insulating tape.

NOTICE!

- The CT referred to in this section is the CT delivered with the inverter.

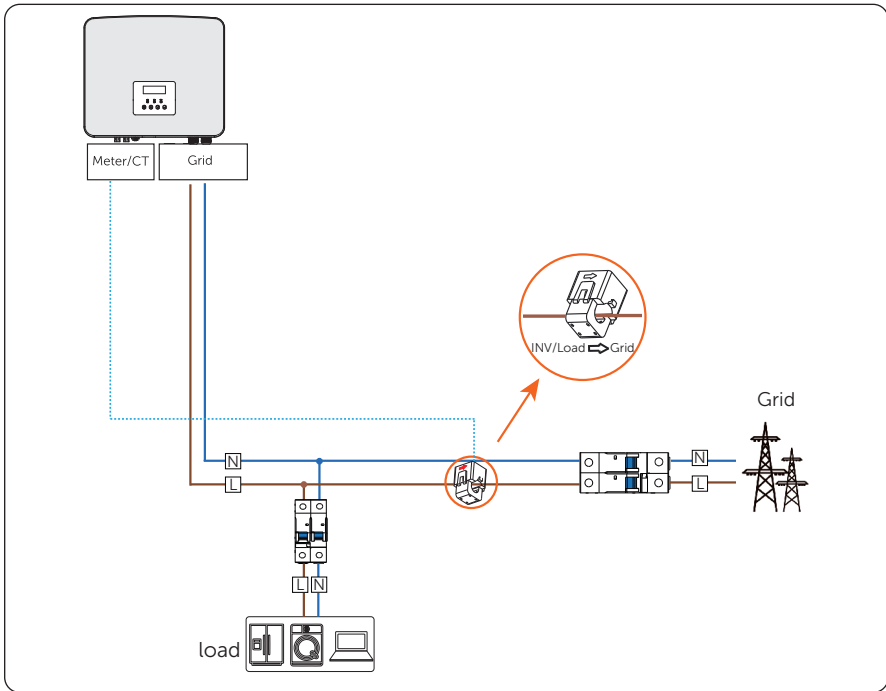

Figure 15-1 System wiring with CT

- * The arrow on the CT must point at the public grid.
- *The emergency load is connected to the EPS terminal of the inverter, which is not shown in the diagram.

Wiring Procedure

Step 1: Clip the CT to the L cable of the grid.

Make sure the arrow on the CT is pointing to the grid side from the inverter.

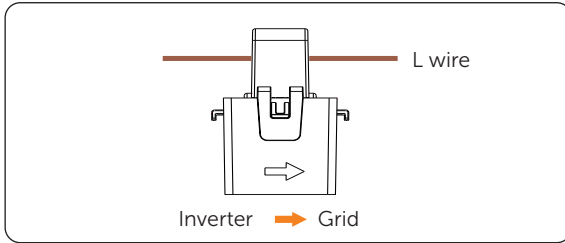

Figure 15-2 Clipping CT to grid cables

Step 2: Use the RJ45 coupler to connect the extension communication cable and the CT.

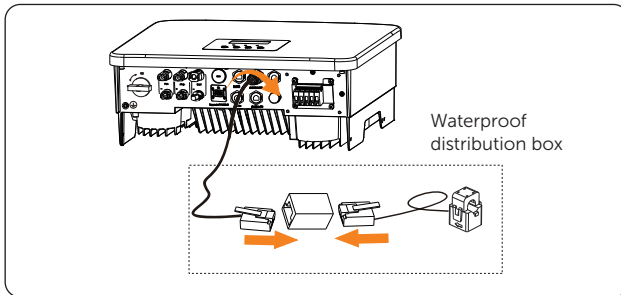

Figure 15-3 Connecting the inverter to the CT

Setting Procedure

After connecting CT to the inverter, you need to enable it on the inverter before it can be used.

Select **Advance Settings > Meter/CT Setting**, and then select **CT**.

You can check the CT connection status in **Meter/CT Check**. For details, see "[Setting Meter/CT Check](#)".

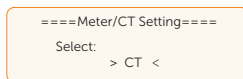

Figure 15-4 Setting CT for the inverter

15.7.3 Connection of Direct-connected Meter

NOTICE!

- SolaX DDSU666 is used for example.

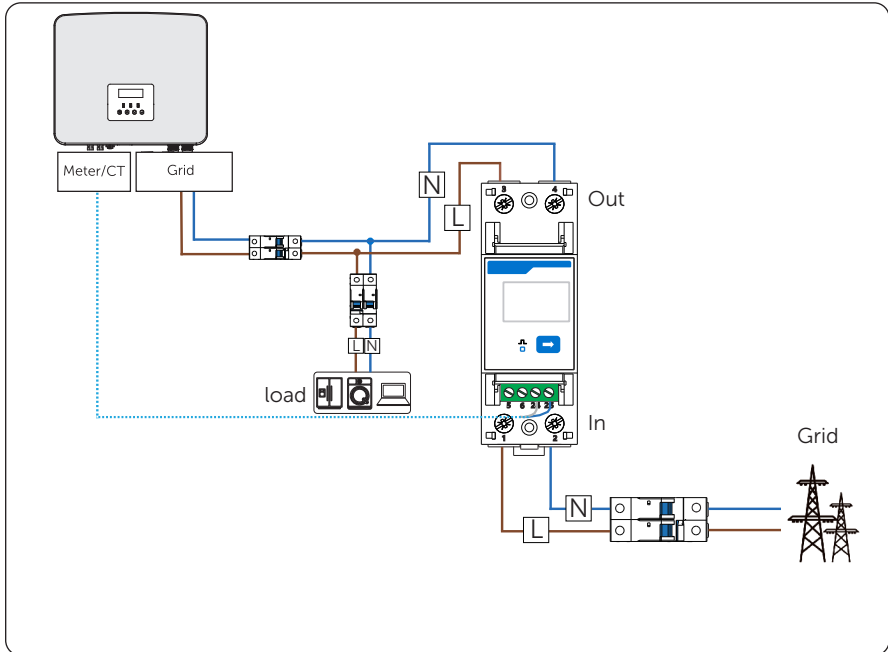

Figure 15-3 System wiring with SolaX DDSU666

*Terminal 1 and 2 of the meter must be connected to the grid side, and terminal 3 and 4 be connected to the inverter side of the system. Otherwise, the system power data might be misread.

*The emergency load is connected to the EPS terminal of the inverter, which is not shown in the diagram.

Meter Terminal Definition

Table 15-1 Terminal definition of DDSU666

Terminal No.	Definition	Description
1, 3	UL	Voltage input and output terminal, connected to the L wire
2, 4	UN	Phase N voltage input and output terminal, connected to the N wire
24	RS485A	RS485 terminal A
25	RS485B	RS485 terminal B

Wiring Procedure

Step 1: Strip around 10 mm wire insulation off the L and N cables, and then connect the L wire to terminal 1 and 3, and the N wire to terminal 2 and 4 in sequence.

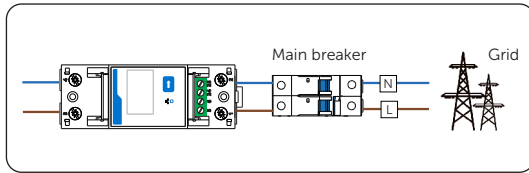

Figure 15-5 Connecting DDSU666 to the grid

Step 2: Strip 15 mm wire insulation off the other end of the communication cable.

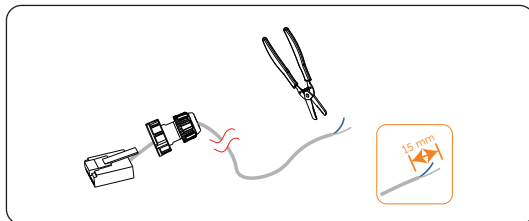

Figure 15-6 Stripping communication cable for meter

Step 3: Connect the conductors to terminal 24 and 25 of the meter.

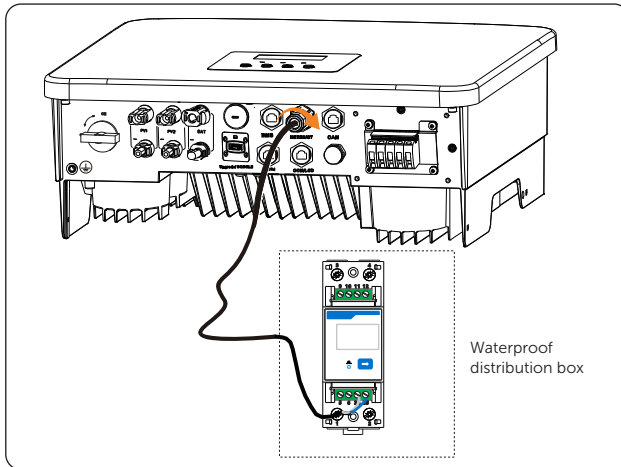

Figure 15-7 Connecting inverter to DDSU666

Setting Procedure

After connecting meter to the inverter, you need to enable it on the inverter before it can be used.

Select **Advance Settings > Meter/CT Setting**, and then select **Meter**.

You can check the meter connection status in **Meter/CT Check**. For details, see [Meter/CT Check](#).

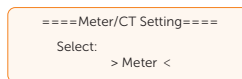

Figure 15-8 Setting meter for the inverter (1)

15.7.4 Connection of CT-connected Meter

NOTICE!

- SolaX DDSU666-CT is used for example.
- The CT referred to in this section is the CT delivered with DDSU666-CT.

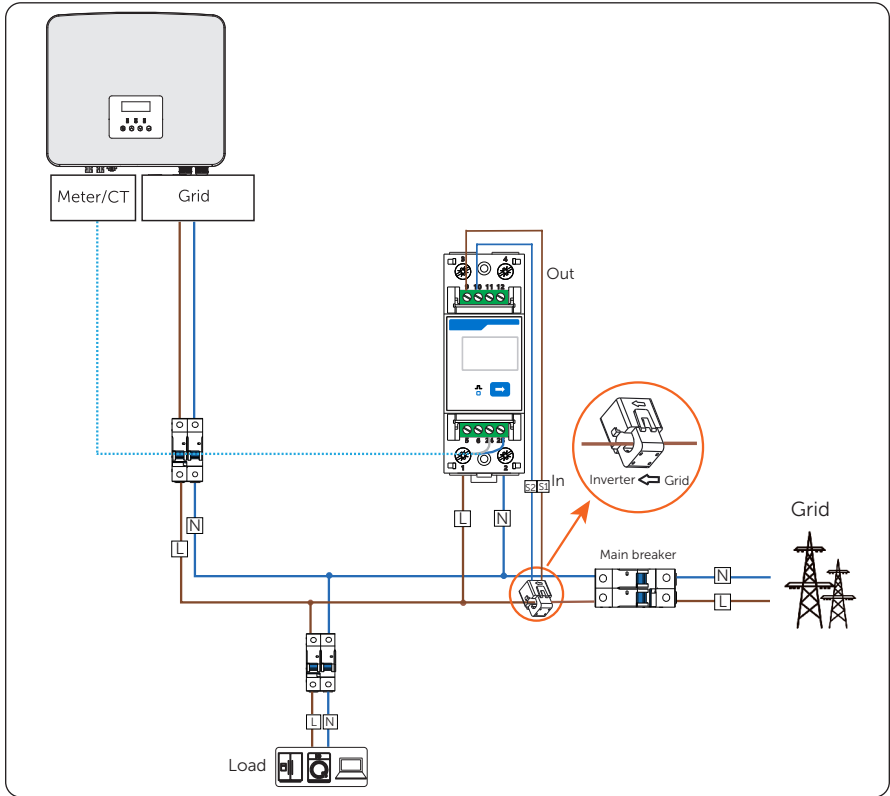

Figure 15-9 System wiring with SolaX DDSU666-CT

*The arrow on the CT must point at the inverter side.

*Terminal 1 and 2 of the meter must be connected to the grid side. Terminal 9 must be connected to the S1 wire of the CT, and terminal 10 be connected to the S2 wire of the CT. Otherwise, the system power data might be misread.

*The emergency load is connected to the EPS terminal of the inverter, which is not shown in the diagram.

Meter Terminal Definition

Table 15-2 Terminal definition of SolaX DDSU666-CT

Terminal No.	Definition	Description
1	UL	Voltage input terminal, connected to the L wire
2	UN	Phase N voltage input terminal, connected to the N wire
9	I*	Current input terminal, connected to S1 wire of CT
10	I	Current output terminal, connected to S2 wire of CT
24	RS485A	RS485 terminal A
25	RS485B	RS485 terminal B

Wiring Procedure

- Step 1:** Strip around 10 mm wire insulation off the L and N cables, and then connect L and N wires respectively to terminal 1 and 2 of the meter.
- Step 2:** Clip the CT onto the L wire in the direction from grid to inverter.
- Step 3:** Connect S1 wire of the CT to terminal 9, and S2 wire of the CT to terminal 10.

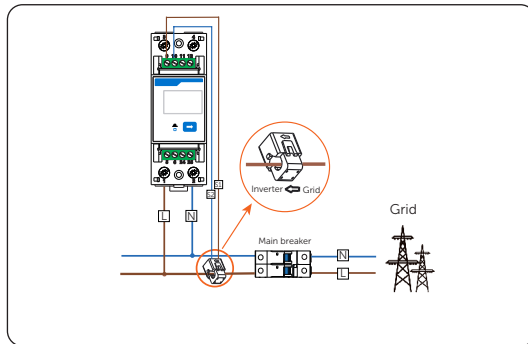

Figure 15-10 Connecting DDSU666-CT to the grid

Step 4: Strip 15 mm wire insulation off the other end of the communication cable.

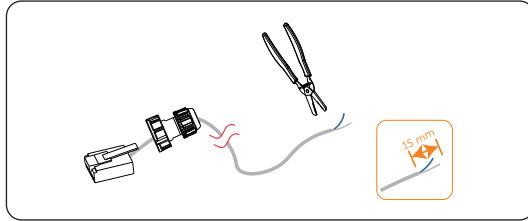

Figure 15-11 Stripping communication cable for meter

Step 5: Connect the conductors to terminal 24 and 25 of the meter.

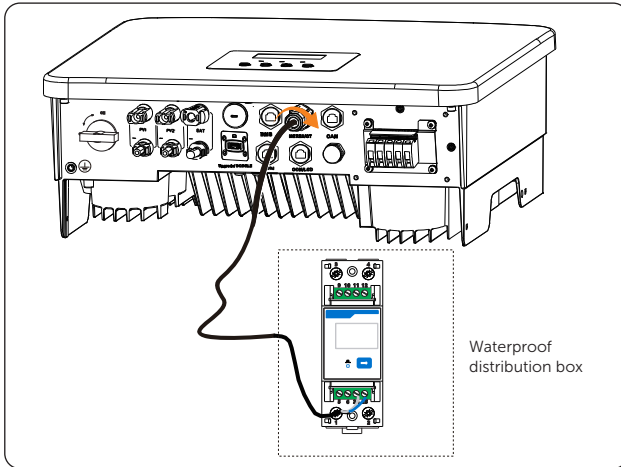

Figure 15-12 Connecting inverter to meter

Setting Procedure

After connecting meter to the inverter, you need to enable it on the inverter before it can be used.

Select **Advance Settings > Meter/CT Setting**, and then select **Meter**.

You can check the meter connection status in **Meter/CT Check**. For details, see [Meter/CT Check](#).

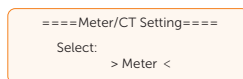

Figure 15-13 Setting meter for the inverter (2)

15.7.5 Connection of Two Meters

If you have another power generation equipment (such as an inverter) at home and wants to monitor both equipment, our inverter provides a Meter 2 Communication function to monitor the other power generation equipment.

NOTICE!

- For connecting CT and meter, or connecting two meters, prepare an RJ45 splitter adapter and a proper waterproof enclosure for it in advance.
- For X1-Hybrid G4 inverter series, Meter 1 and meter 2 can both be CT, direct-connected meter and CT-connected meter. The following diagrams use double CTs and double direct-connected meters for example.

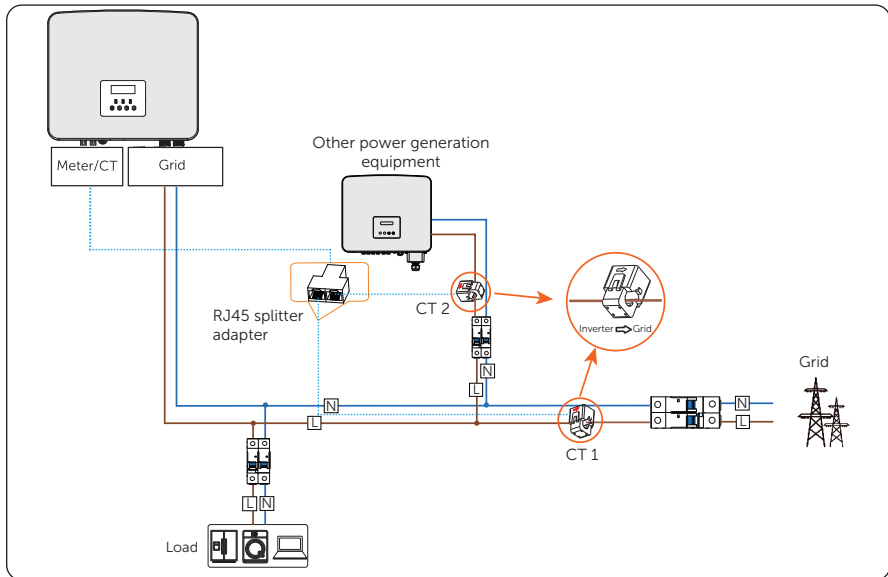

Figure 15-14 Connecting to double CTs

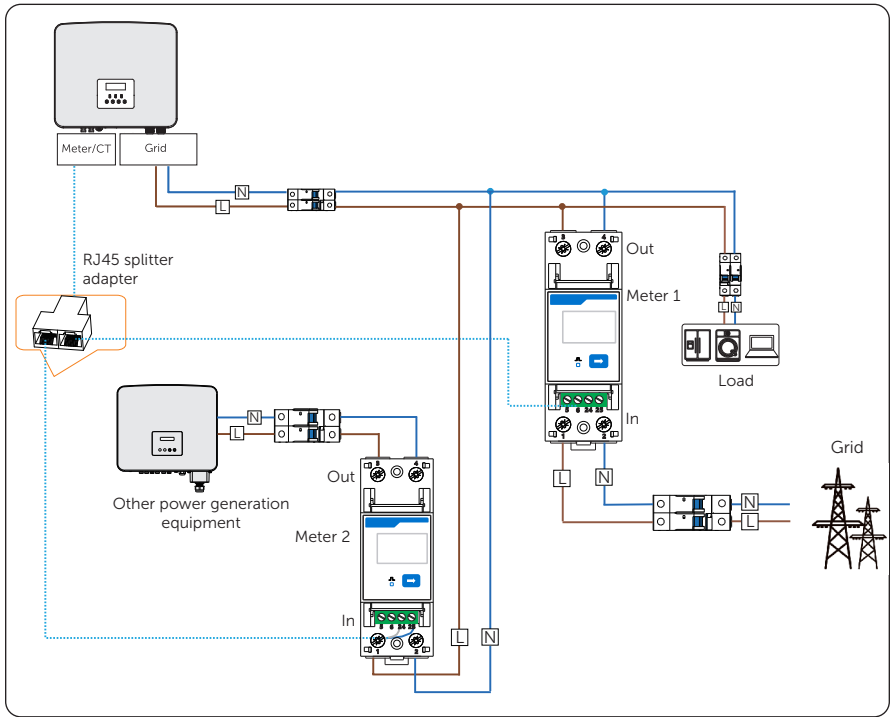

Figure 15-15 Connecting to double direct-connected meters

Wiring Procedure

- Step 1:** Follow the above steps to connect the meter, CT and inverter.
- Step 2:** Connect the RJ45 terminals to the RJ45 splitter adapter.

Setting Procedure

After connecting the CT and meter to the inverter, you need to set parameters on the inverter LCD before they can work normally for the system.

Step 1: Select **Advance Settings > Meter/CT Setting**.

Step 2: Set the Meter/CT:

- » Case 1: Double CTs are connected respectively to the position of Meter 1 and Meter 2. In this case, you only need to select CT, and the inverter will identify the CTs automatically.

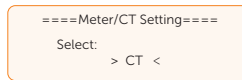

Figure 15-16 Setting CT for the inverter

- » Case 2: CT and Meter 2 are connected (CT for SolaX inverter, Meter 2 for another power generation equipment). CT is set by default. Check whether the address and direction of Meter2 are set based on actual connection.

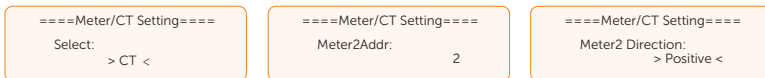

Figure 15-17 Selecting CT and set Meter2 data

- » Case 3: Meter 1 and Meter 2 are connected (Meter 1 for SolaX inverter, Meter 2 for another power generation equipment). Select **Meter** and enable the Meter function. Check whether the address and direction of Meter 1 and Meter 2 are set based on actual connection.

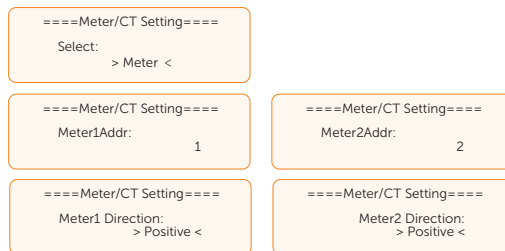

Figure 15-18 Selecting meter and set Meter 1 and Meter 2 data

Related Operation

Setting Meter/CT Check

- **Installation Check:** It is for checking whether the meter/CT has been correctly connected. It is vital to the normal function of the whole system. Therefore, we recommend performing installation check after connecting the meter/CT.

Select **Meter/CT Setting > Meter/CT Check**, and then enable **Installation Check**.

The system will perform meter/CT check immediately after you enable it, and then automatically restores to the disabled status after the check completes.



- **Cyclic Check:** It is for periodically checking whether the meter/CT is in good condition when the inverter is running.

Select **Meter/CT Setting > Meter/CT Check**, and then enable **Cyclic Check**.

Once Cyclic Check is enabled, the system will check the meter/CT status periodically based on the defined cycle.





Figure 15-19 Checking CT/Meter status

Contact Information





UNITED KINGDOM

 Unit C-D Riversdale House, Riversdale Road, Atherstone, CV9 1FA
 +44 (0) 2476 586 998
 service.uk@solaxpower.com





TURKEY

 Fevzi Çakmak mah. asım cd. no 88 A Karatay / Konya / Türkiye
 service.tr@solaxpower.com



USA

 3780 Kilroy Airport Way, Suite 200, Long Beach, CA, US 90806
 +1 (408) 690 9464
 info@solaxpower.com





POLAND

 WARSAW AL. JANA P. II 27. POST
 +48 662 430 292
 service.pl@solaxpower.com



ITALY

 +39 011 19800998
 support@solaxpower.it





PAKISTAN

 service.pk@solaxpower.com



AUSTRALIA

 21 Nicholas Dr, Dandenong South VIC 3175
 +61 1300 476 529
 service@solaxpower.com.au







GERMANY

 Am Tullnaupark 8, 90402 Nürnberg, Germany
 +49 (0) 6142 4091 664
 service.eu@solaxpower.com
 service.dach@solaxpower.com





NETHERLANDS

 Twekkeler-Es 15 7547 ST Enschede
 +31 (0) 8527 37932
 service.eu@solaxpower.com
 service.bnl@solaxpower.com





SPAIN

 +34 9373 79607
 tecnico@solaxpower.com



BRAZIL

 +55 (34) 9667 0319
 info@solaxpower.com



SOUTH AFRICA

 service.za@solaxpower.com



SolaX Power Network Technology (Zhejiang) Co., Ltd.

Add.: No. 278, Shizhu Road, Chengnan Sub-district, Tonglu County,
Hangzhou, Zhejiang, China
E-mail: info@solaxpower.com

Copyright © SolaX Power Network Technology (Zhejiang) Co., Ltd. All rights reserved.



320101081103