



# GoodWe Technical Workshop



**Welcome to SegenSolar – Your Solar PV Distributor**

## Single Phase and Three Phase

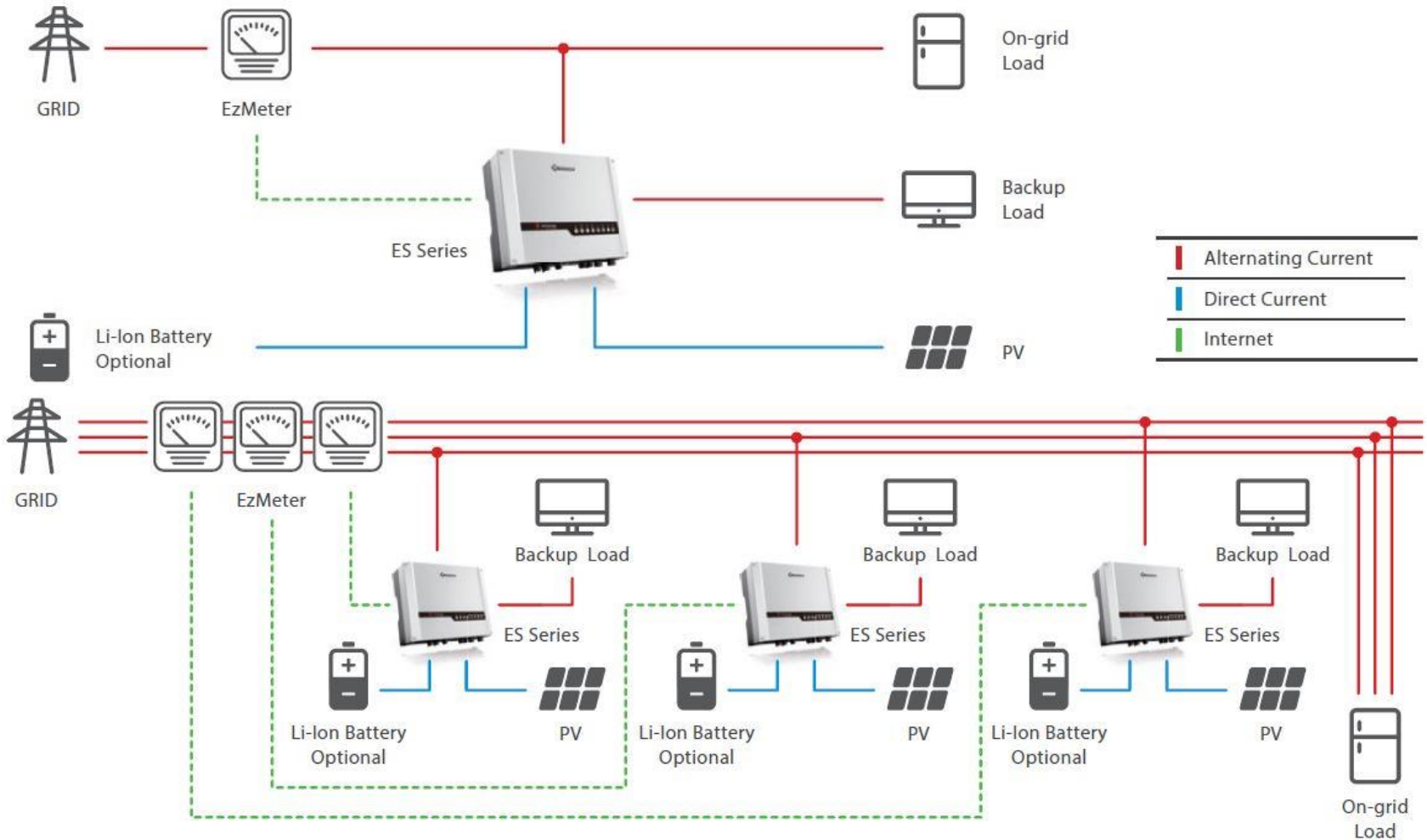

## Pylontech batteries



- Vertical industry integration ensures more than 6000 cycles at 80% DoD or 4500 cycles at 90% DoD
- Nominal current of 25A for US2000B
- Nominal current of 37A for US3000B
- Modular units allow for flexible design and upgrade options
- Compatible with GoodWe ES and EM
- Simple buckle fixing minimize the installation time and cost
- Safety Cert.TÜV CE UN38.3 TLC



Basic Parameters	US2000B Plus	Phantom-S	US3000
Nominal Voltage (V)	48	48	48
Nominal Capacity (Wh)	2400	2400	3552
Usable Capacity (Wh)	2200	2200	3200
Dimension (mm)	442*410*89	445*428*97.5	442*420*132
Weight (Kg)	24	24	32
Discharge Voltage (V)	45 ~ 53.5	5 ~ 53.5	45~53.5
Charge Voltage (V)	52.5 ~ 53.5	52.5~53.5	52.5~53.5
Charge / Discharge Current (A)	25 (Recommended)	25 (Recommended)	37 (Recommended)
	50 (Max)	50 (Max)	74 (Max)
	100 (Peak@15s)	100 (Peak@15s)	100 (Peak@15s)
Communication Port	RS232, RS485, CAN	RS232, RS485, CAN	RS232, RS485, CAN
Single string quantity(pcs)	8	8	8
Working Temperature/°C	0~50	0~50	0~50
Shelf Temperature/°C	-20~60	-20~60	-20~60
Humidity	5%~85%	5%~85%	5%~85%
Altitude (m)	<2000	<2000	<2000
Design life	10+ Years (25°C/77°F)	10+ Years (25°C/77°F)	10+ Years (25°C/77°F)
Cycle Life	>4500, 25°C	>4500, 25°C	>4500, 25°C
Authentication Level	TÜV / CE / UN38.3	TÜV / CE / UN38.3	TÜV / CE / UN38.3

Inverter		Battery	Communication	Cable Supply	Coupling type	Application	Key Features	Firmware Ver.	Installation
Brand of Inverter	Type	US2000 / US3000 / Phantom-S / Force-L1							
Victron Energy	Multi / Quattro 48V (via Venus-device)		CAN	RJ45	DC	On/off-grid*	Activation: Yes; Force charge: Yes	422/V2.15	Wall mounting
Schneider-Electric	XW+ series		CAN	RJ45	DCAC	On/off-grid	Activation: Yes; Force charge: Yes		Vertical
SolaX Power	SK-SU, SK-TL, SK-BMU		CAN/RS232	RJ45	DCAC	On-grid	Activation: PV only; Force charge: Yes		Wall mounting
Goodwe	GW-BP/SBP GW-ES/EM		CAN	RJ45	DCAC	On-grid	Activation: Yes; Force charge: Yes		Wall mounting
Imeon Energy	IMEON 3.6 & 9.12		CAN	RJ45	DCAC	On/off-grid	Activation: Yes; Force charge: Yes	V1.7.6.5	Wall mounting
Studer Innotec	Xtender 48V serie VarioString serie VarioTrack 48V serie		CAN	RJ45	DC	On/off-grid	Activation: No; Force charge: Yes	R652	Wall mounting
Selectronic	SPMC in 48V		CAN	RJ45	DC	On/off-grid	Activation: No; Force charge: Yes		Wall mounting
Voltronic	Infinisolar series 48V Axpert series 48V**		RS485(9600)	RJ45	DC	On/off-grid	Activation: Yes; Force charge: Yes	V1.00/00.32	Wall mounting
Sofar	ME3000SP, HYD series		RS485(115200)/ CAN	RJ45	AC	On-grid	Activation: Yes; Force charge: Yes	V1.2	Wall mounting
Sermatec	SMT-5K-TL-LV		CAN	RJ45	DCAC	On/off-grid	Activation: Yes; Force charge: Yes		Wall mounting
Zucchetti Centro Sistemi	Azzurro 3000SP; Azzurro HYD3000/6000-ES		RS485(115200)/ CAN	RJ45	AC	On-grid	Activation: Yes; Force charge: Yes	V1.2	Wall mounting
Solis	RHI-3K-5K-48ES		CAN	RJ45	DC	On/off-grid	Activation: PV only; Force charge: Yes	90009	Wall mounting
Redback	SH5000		RS485(115200)	RJ45	DCAC	On-grid	Activation: PV only; Force charge: No		Vertical
Alpha & Outback Energy	SPC III 5000-48		RS485(9600)	RJ45	DC	On/off-grid	Activation: Yes; Force charge: Yes	V1.00/00.32	Wall mounting
Lux Power	LXP Hybrid/ACS series		CAN	RJ45	DCAC	On-grid	Activation: Yes; Force charge: Yes	AA1.0	Wall mounting
Sungrow	SH5K		CAN	Terminal	DC	On-grid	Activation: 30mins; Force charge: Yes	V13	Wall mounting
Morningstar	TriStar MPPT in 48V TriStar MPPT 600V in 48V TriStar PWM TS-45 in 48V		N/A	N/A	DC	On/off-grid	Activation: PV only; Force charge: No	v32b	Wall mounting
Delios	DLS/C series DLS AC series		CAN	RJ45	DCAC	On/off-grid	Activation: No; Force charge: Yes	A 1.30; B 1.18; C1.27	Wall mounting
MLT	Oasis 448, 648		N/A	N/A	AC	Off-grid	Activation: No; Force charge: Yes	V2.19	Wall mounting
Steca	Solarix PLI 5000-48		N/A	N/A	DC	Off-grid	Activation: Manual; Force charge: No		Wall mounting
SAJ	Sunfree series		RS485(9600)	RJ45	DCAC	On/off-grid	Activation: Yes; Force charge: Yes	V2.031/V1.037/V1.037	Wall mounting
SolarMax	ES series AC series		CAN	RJ45	DCAC	On/off-grid	Activation: No; Force charge: Yes	A 1.30; B 1.18; C1.27	Wall mounting
Growatt	SPH6000		CAN	RJ45	DCAC	On/off-grid	Activation: No; Force charge: Yes	RA1.0	Wall mounting
Axioma Energy	ISPWM 5000 ISMPTT BF 3000 - 5000 ISGRID (BF) 3000 - 5000		N/A	N/A	DC	On/off-grid	Activation: No Force charge: No		Wall mounting
Kehua	SPH5000-BL		CAN	RJ45	DCAC	On-grid	Activation: Yes; Force charge: Yes	V1.00.013	Wall mounting
GMDE	SolDate 3700TL+BM024		RS485(9600)	RJ45	DCAC	On-grid	Activation: No; Force charge: Yes	V2.0.1	Wall mounting
Dowell	iPower		RS485(9600)/CAN	Terminal	DCAC	On-grid	Activation: PV only; Force charge: Yes	V3.03	Wall mounting



## If the scenario requires multiple Pylon battery modules

Internal communication of the Pylon batteries is limited to 8 modules, Pylon can manage battery information for only 8 modules in parallel per inverter with the address allocated automatically.

For larger banks, a Pylontech LV-Hub can be used to connect 5 banks of 8 batteries





## Module Layout

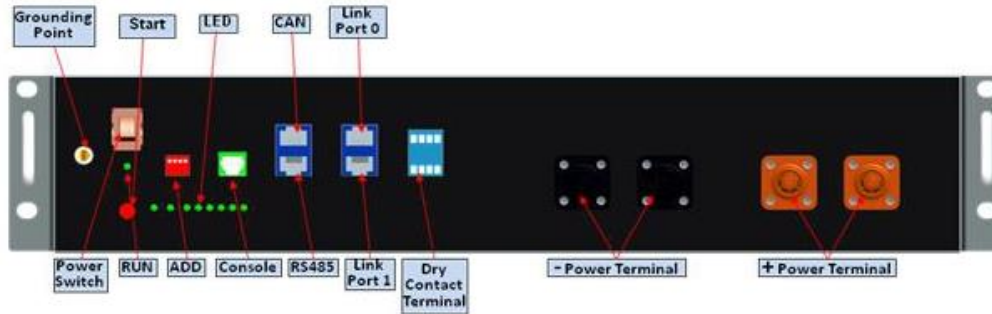

## Front Panel

## Power Switch

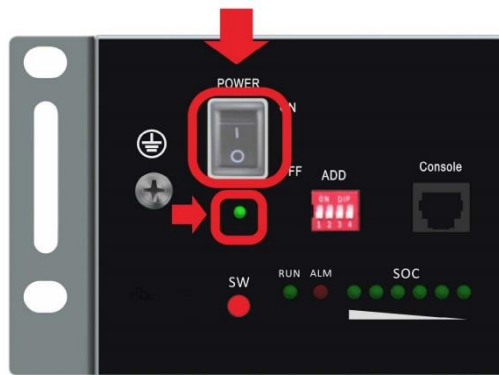

## Link Ports



## Pylon Cables

- **Cable accessories included with the battery**

Two power cables, one communication cable and one earth cable

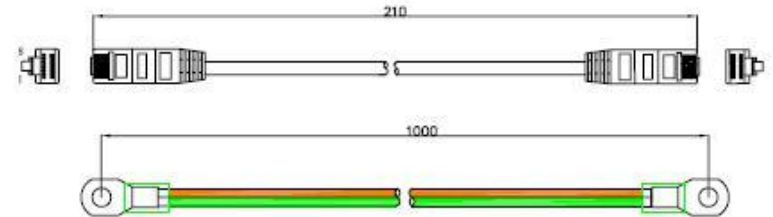
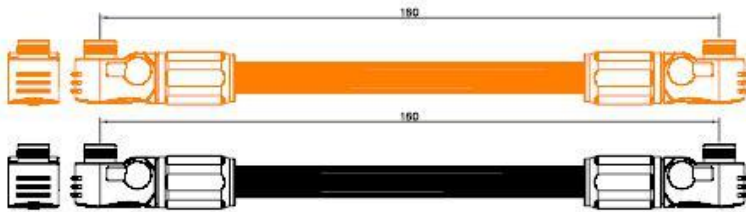

- **Cable Pack, required accessory (Purchased separately)**

Two long power cables and one communication cable

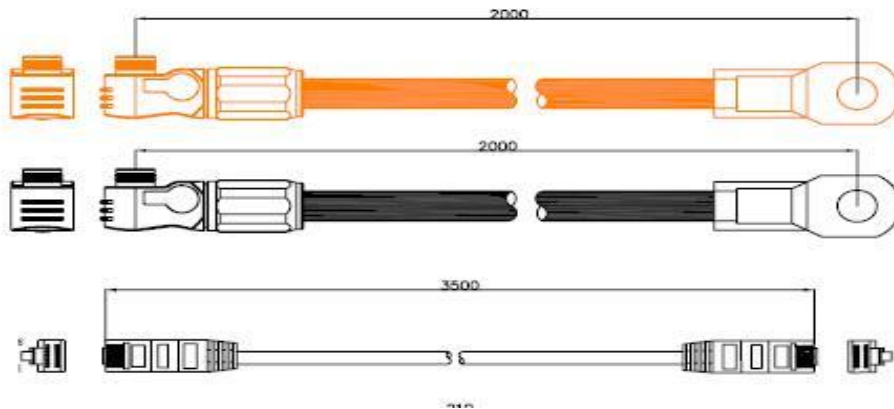

- **NOTE**

The Cable pack must be purchased separately and is not included with the battery.

The Power cables is rated for a current rating of 120A.

a Maximum of 5 battery modules can be connected with one cable pack



## Cabinet / Brackets



## BYD Batteries



- Safe Battery Chemistry – LiFePO<sub>4</sub> (Lithium iron phosphate) the thermal runaway temperature is over 480°C
- Railway and Automotive Standard Battery – 6+ years track record in the EV market and knowledge in ESS
- High Power Output – 1C Nominal and 2C Peak
- Easy Installation and Uninterruptible Maintenance – Complete modular design.
- Flexible Extension Life Time – Can expand storage at any time
- Compatible with GoodWe ES and EM
- 10 Year Warranty – Covers the battery for 1 full cycle per day for the duration of the warranty

Model	B-Box Pro 2.5	B-Box Pro 5.0	B-Box Pro 7.5	B-Box Pro 10.0	B-Box Pro 13.8
Battery Type	LiFePO <sub>4</sub>				
Battery Module	1 module	B-Plus 2.5 (2.56 kWh) 2 modules		3 modules	4 modules
Usable Energy <sup>[1]</sup> [kWh]	2.56	5.12	7.68	10.24	13.8
Max Output Power [kW]	2.56	5.12	7.68	10.24	12.8
Peak Output Power [kW]	5.12, 30s	10.24, 30s	15.36, 30s	20.48, 30s	13.3, 60s
Round-Trip Efficiency	≥95.3% (Under test condition [1] )				
Nominal Voltage [V]	51.2				
Operating Voltage Range [V]	43.2~56.4				
Communication	CAN / RS485				
Dimension [W × H × D, mm]	600×883×510				650×800×550
Net Weight [kg]	79	113	147	181	175
Enclosure Protection Rating	IP20				
Warranty	10 years				
Ambient Temperature Range <sup>[2]</sup> [ °C ]	-10 ~ +50				
Certification & Safety Standard	TUV / CE / UN38.3 Sicherheitsleitfaden Li-Ionen-Hausspeicher				CE / RCM / UN38.3
Scalability	Max. 8 B-Box Pro 10.0 systems in parallel				Max. 32 systems in parallel
Compatible Inverters	SMA / GOODWE / SOLAX / Victron, more brands to be announced				

[1] Test conditions: 100% DOD, 0.5C charge & discharge @+25 °C

[2] -10 °C ~ 10 °C will be derating

\*System Usable Energy may be variant with different inverter brands

# Inverter Compatibility List

Inverter Firmware version: minimum required firmware version for ARM is 03.

B-Box firmware version: minimum required firmware version for BMU is V4-10.

## 1 Phase on Grid

Inverter Type	B-Plus 2.5	Cabinet
---------------	------------	---------

<sup>1</sup> Shall bypass main circuit breaker when the system is off grid application.

### Minimum Configuration list of B-Box series products

GW3648D-ES	≥ <sup>1</sup> 2	≥1
GW5048D-ES	≥ <sup>1</sup> 2	≥1

## 1 Phase off Grid

Inverter Type	B-Plus 2.5	Cabinet
GW3648D-ES	≥2	≥1
GW5048D-ES	≥2	≥1

You are here: Home » Photovoltaic » BYD



## B-BOX 13.8 - Li-ion unit, includes 1x Cabinet + 2x Batteries

Part No: BYD-B-BOX-13.8 Storage Systems - Li-ion Battery Pack

### Brief introduction

The BYD B-Box is a lithium iron phosphate (LiFePO4) battery unit with battery management system (BMS) for u

Thanks to its modular design, the B-Box grows with its requirements. Start with B-Box 13.8 and extend any time

### Features of system

- Parallel interconnection of several systems
  - Flexible combination of capacity
  - Support for RS485-/CAN-communication
  - Lithium iron phosphate (LiFePO4) battery:
- Maximum security, cycle-stability, energy density, Depth of discharge and efficiency
- Easy to install

[Data Sheet BYD B-PLUS HV LV new](#)

[Data Sheet Datenblatt \(German\)](#)

[Installation Manual BYD B-BOX 13.8](#)

[Product Compatibility B-BOX 13.8 10-2017](#)

[Safety Transport & Handling Documentation BYD 12.8-13.8](#)

[User Manual Bedienungsanleitung \(German\)](#)

[User Manual BYD B-BOX 13.8](#)

[Warranty BYD SA](#)

[Warranty Submission Form](#)

## Connecting multiple BYD Modules

### B-Box 2.5, 5, 7.5, 10

- The BYD BMU can communicate with up to 32 battery modules.
- Only two BYD B-Box battery modules can be wall mounted using the Wall Mount Bracket
- If more than 3 modules is required the B-Box 10 cabinet must be used and up to maximum of 8 B-Box 10 cabinets can be connected in parallel for a maximum of 80kWh

### B-Box 13.8

- The B-Box 13.8 can scale up to 32 units in parallel for a total of 441kWh of storage

The Cabinets are fitted with a BMU and bus bars, the internal bus bars are intended for paralleling the modules installed inside the cabinet.

Part A – Installation Training

# Parallel Communication

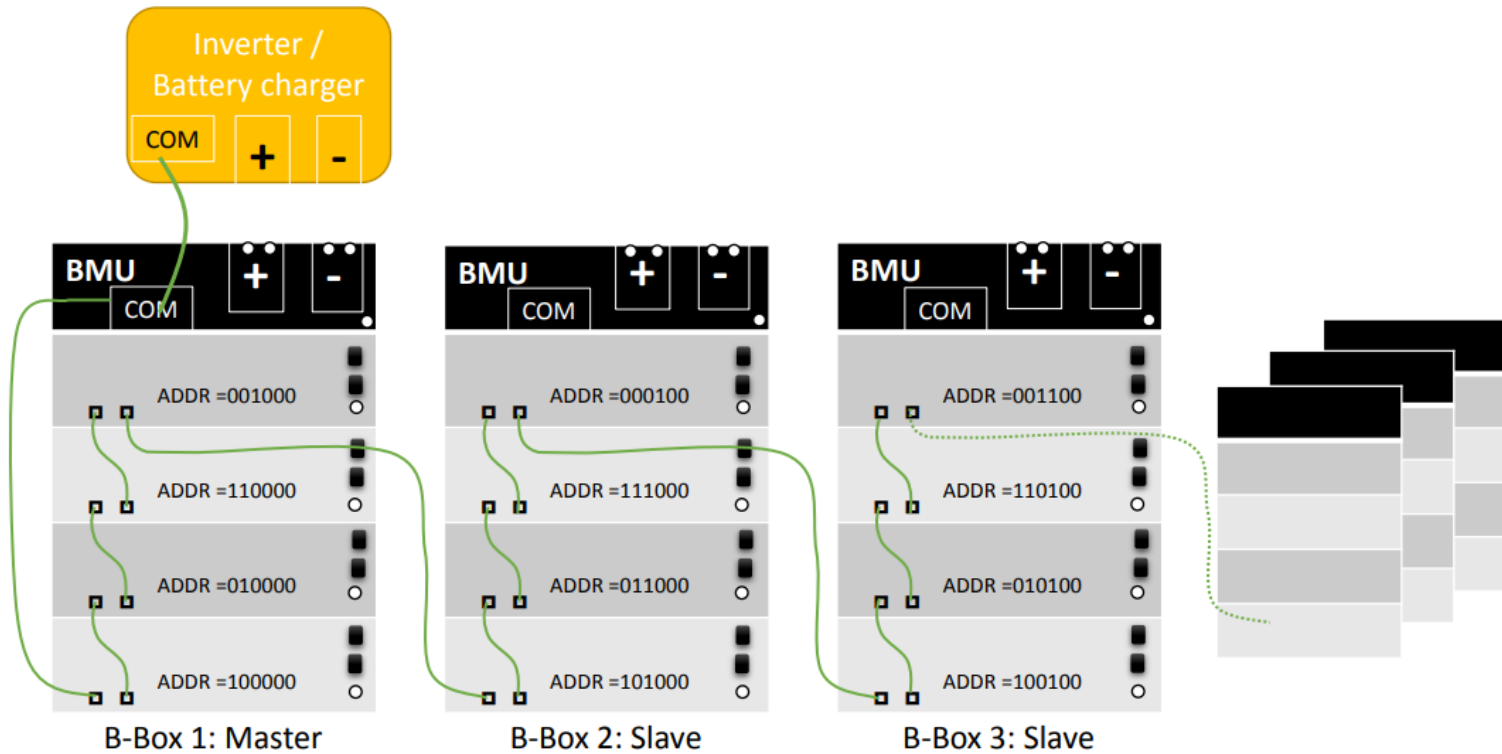



B-Box Professional installation guidance

**7.2 Battery address setting list (from 1~32 batteries):**

Battery No.	Address	Battery No.	Address
1	100000	17	100010
2	010000	18	010010
3	110000	19	110010
4	001000	20	001010
5	101000	21	101010
6	011000	22	011010
7	111000	23	111010
8	000100	24	000110
9	100100	25	100110
10	010100	26	010110
11	110100	27	110110
12	001100	28	001110
13	101100	29	101110
14	011100	30	011110
15	111100	31	111110
16	000010	32	000001

# Installation, commissioning and updating firmware

- Hybrid inverter overview & main components
- Six work modes (scenarios)
- Firmware Upgrade
- Commission the inverter
- Choosing battery type
- Wiring
- Fault finding
- System monitoring
- Pylon Application Note and Documents
- Warranty

## Hybrid inverter Overview



## Hybrid Block Diagram

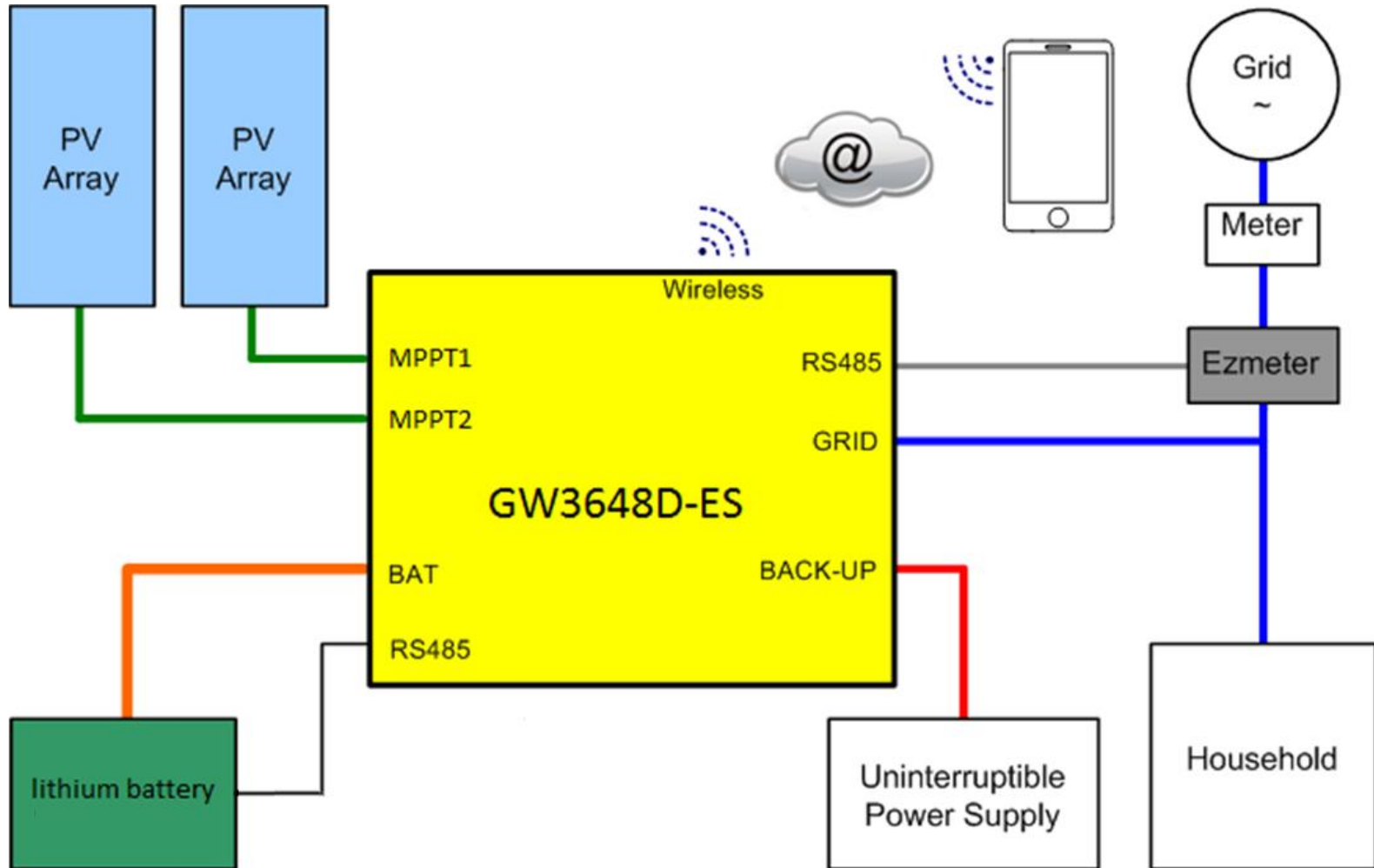

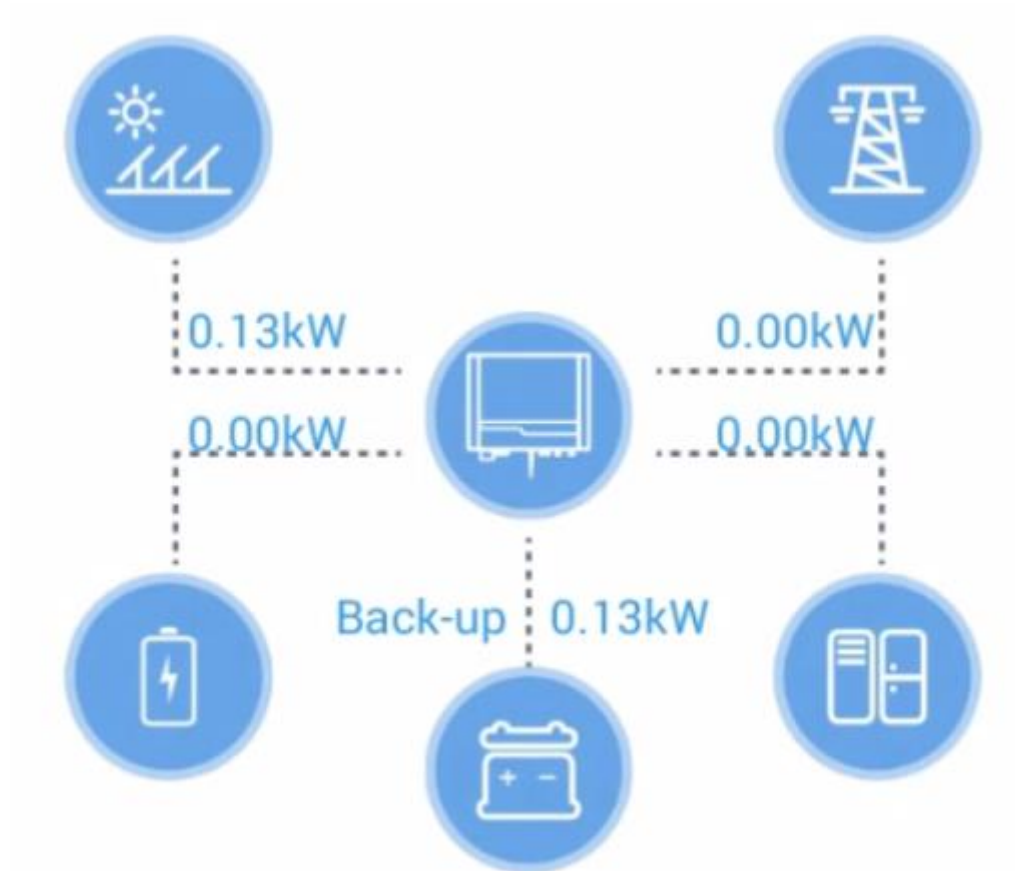



## Before Installation

- After unpacking, please check the product and packing list, if the product is damaged or there is missing components, please contact Segen.
- Before installation, ensure that the battery is turned off.
- Double check the polarity, do not swap around the positive and negative leads.
- Do not connect the battery directly to AC.
- The embedded BMS in the battery is designed for 48VDC, please DO NOT connect batteries in series.
- Battery system must be well grounded with a resistance less than  $1\Omega$ .
- The battery can only be used with inverters approved by pylon.

## Battery Connection

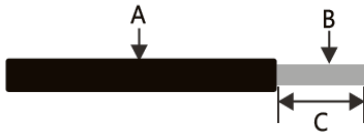

Grade	Description	Value
A	O.D.	10~12mm
B	Conductor Material Sectional Area	20~25mm <sup>2</sup>
C	Bare Wire Length	10mm around

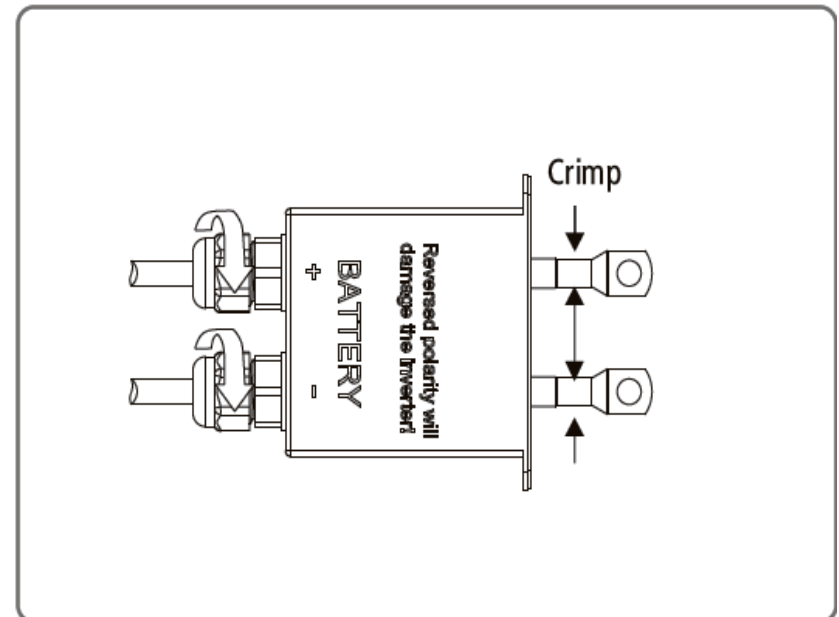
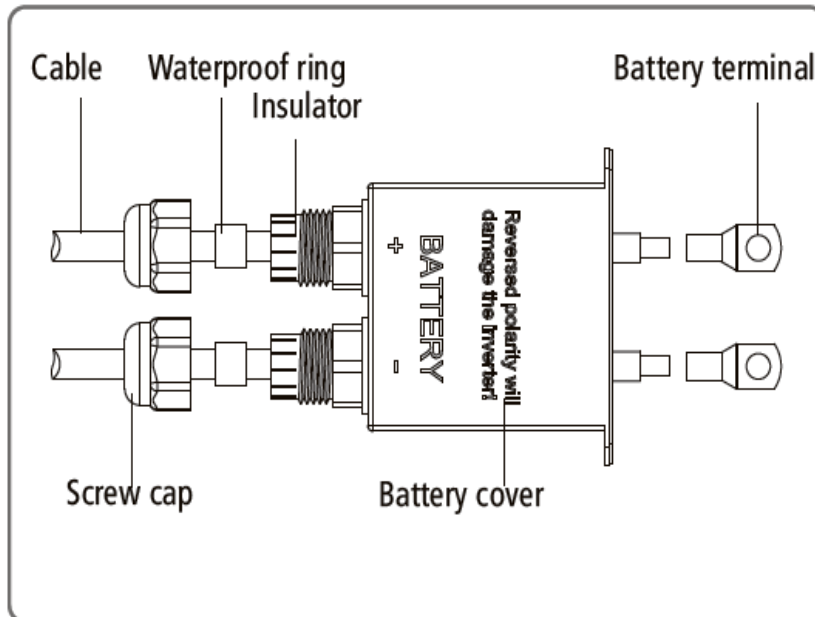

## EzMeter

- ❖ Standard accessory with the inverter.
- ❖ Controls energy exported to the grid and the work modes of the Energy Storage system.
- ❖ Communicates with the ES inverter via a RS485 cable.
- ❖ Meter reading NOT used, treat this device as a Black Box.
- ❖ LED on the bottom left blinks to indicate the system is running
- ❖ Equipped with CT clamp for current measurement

## Six Work Modes

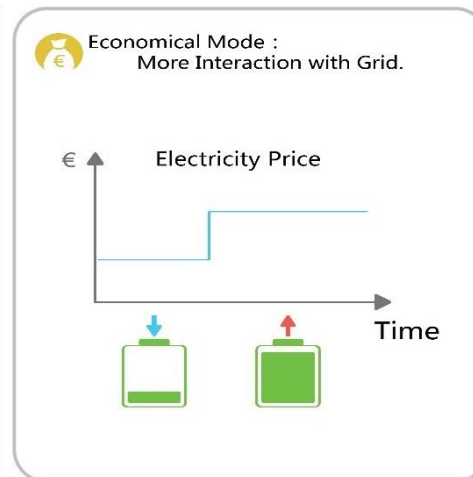
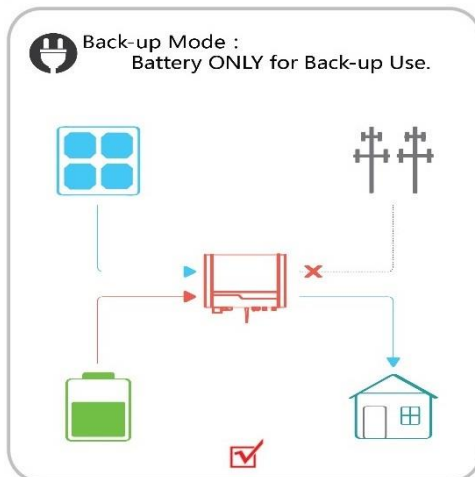
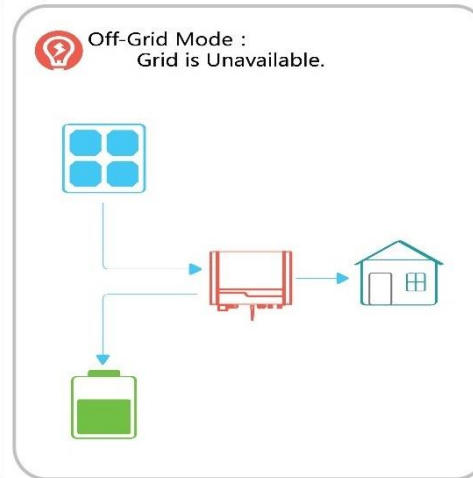
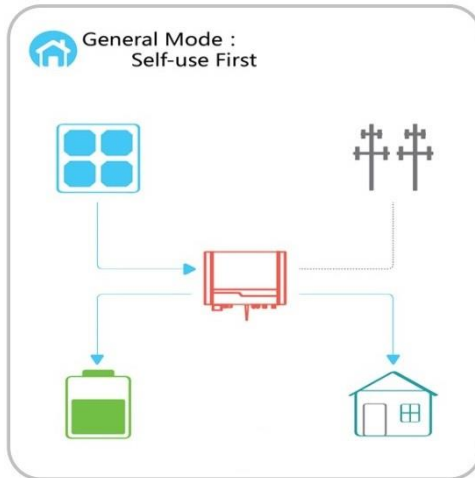



## Mode 1

- DC, current
- DC, no current
- AC, current
- AC, no current

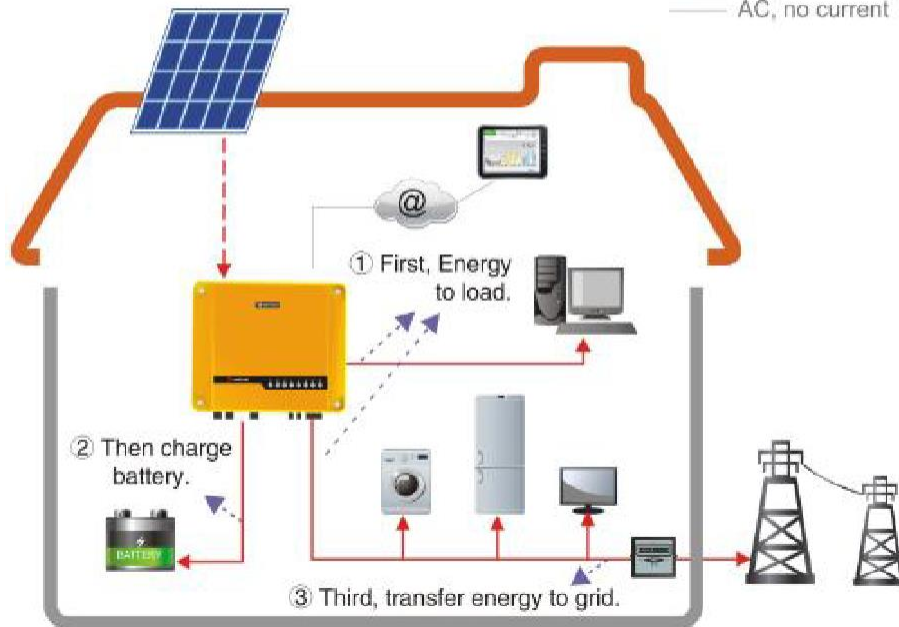

## Mode 1

### Condition: PV ON; Peak Generation

Energy produced by the PV system is for self-consumption optimization. Solar energy will firstly support the load, secondly it will charge the battery and finally export to the grid or draw from the grid, if the load demands more energy.

## Mode 2

- DC, current
- DC, no current
- AC, current
- AC, no current

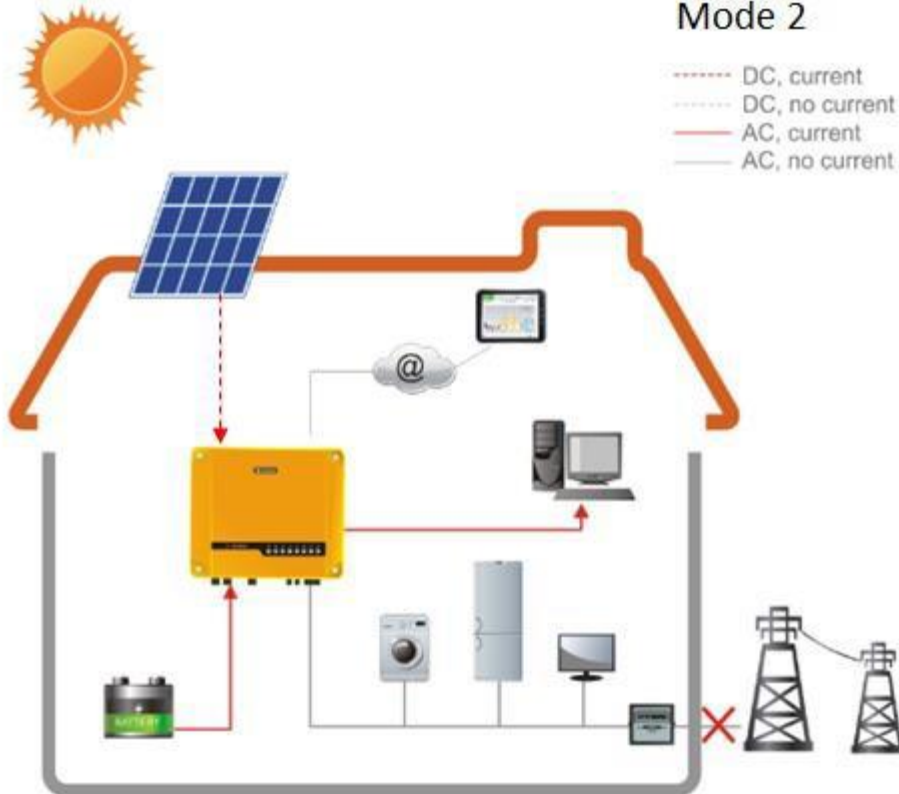

## Mode 2

Condition: Day time, grid fails

The system automatically switches to back-up mode. Solar energy will first support the load connected to the back-up side. If more energy is generated, it will be used to charge the battery.





### Mode 3

- DC, current
- DC, no current
- AC, current
- AC, no current



### Mode 3

#### Condition: System without Battery

Solar energy will first support the load, excess power will be exported to the grid. If generation level is too low, power will be imported from the grid.

## Mode 4

- DC, current
- DC, no current
- AC, current
- AC, no current

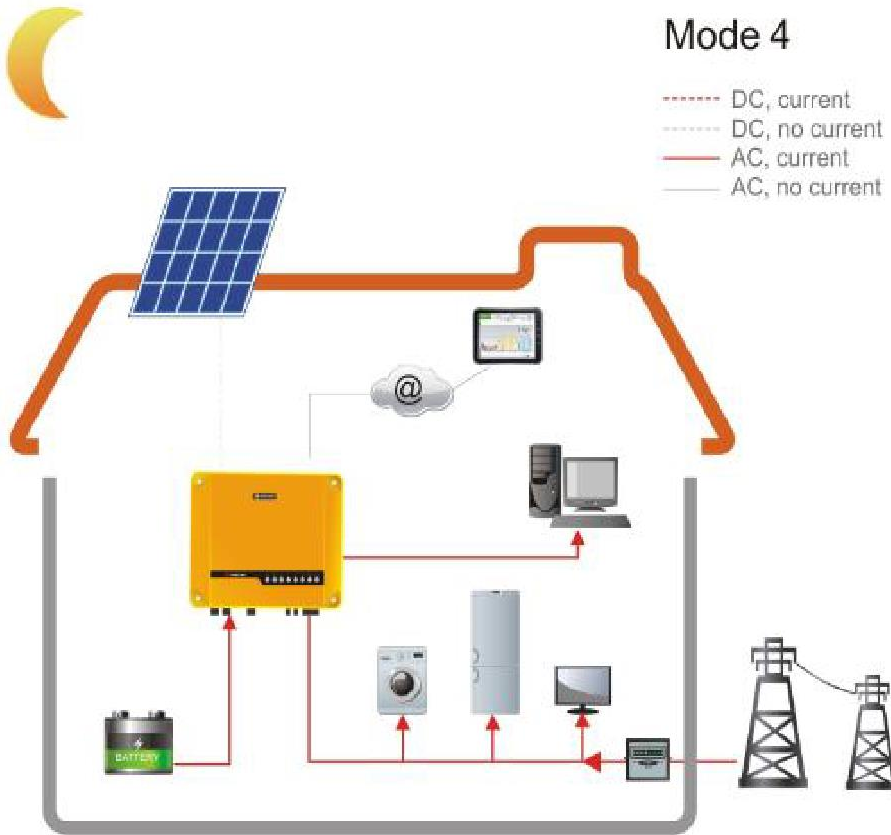

## Mode 4

### Condition: Night-time

ES inverter will discharge the battery to support the load. If the battery stored energy is not enough, the rest of the power will be supplied from the grid.

## Mode 5

- DC, current
- DC, no current
- AC, current
- AC, no current



## Mode 5

Condition: Night time, grid fails

Once the grid fails, the system automatically switches to back-up mode. ES inverter will discharge the battery to support the load.

## Mode 6

- DC, current
- DC, no current
- AC, current
- AC, no current

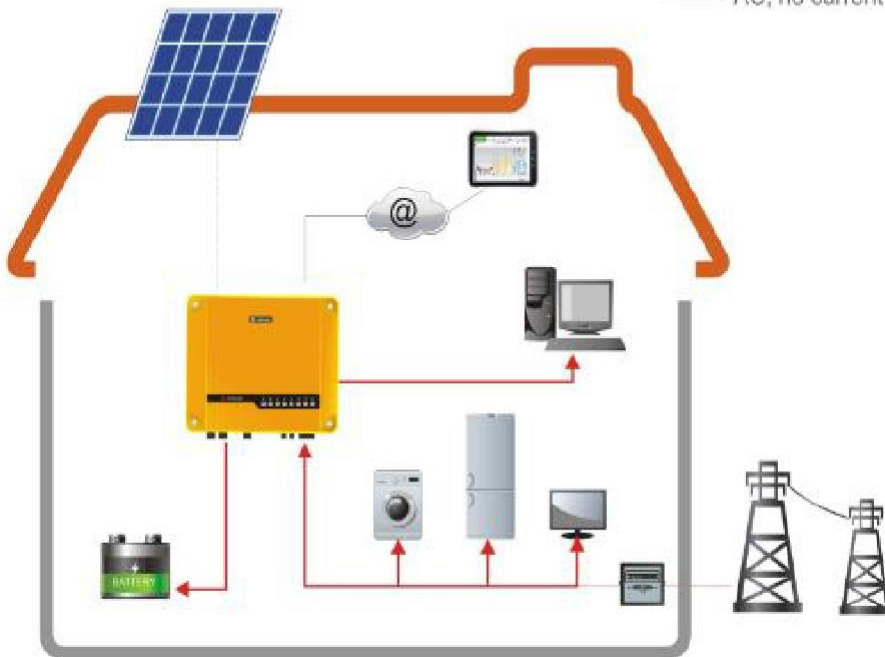

## Mode 6

### Condition: Use as UPS

If the customer wants to use the system as UPS, the inverter can also be set to charge the battery by the grid.

## Firmware Upgrade

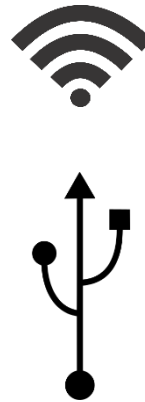

## Updating Inverter Firmware



USB Cable

Type A male to Type A male cable



## Step 1: Remove the Meter Cover / Antenna block



GoodWe ES

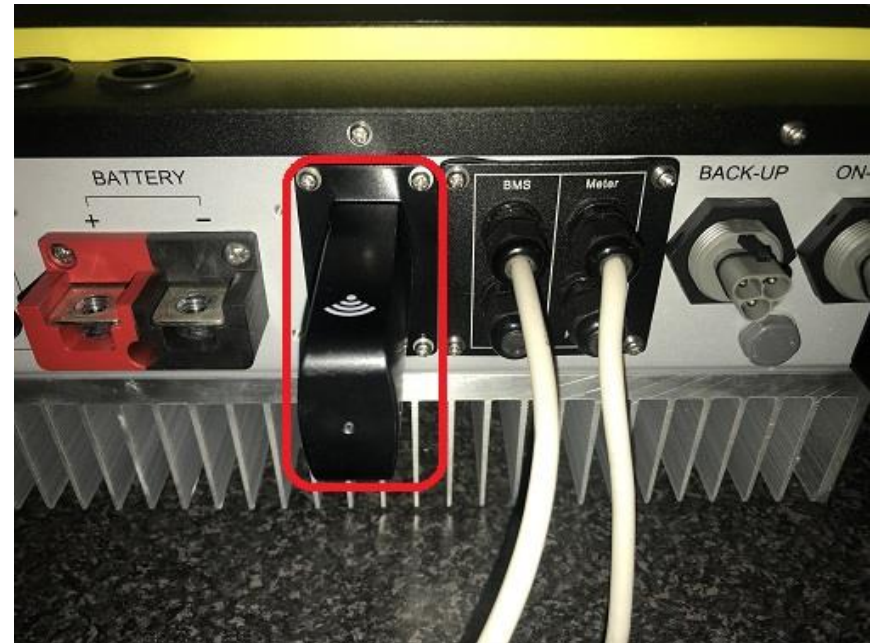

GoodWe EM

## Step 2: Plug the USB cable into the USB port

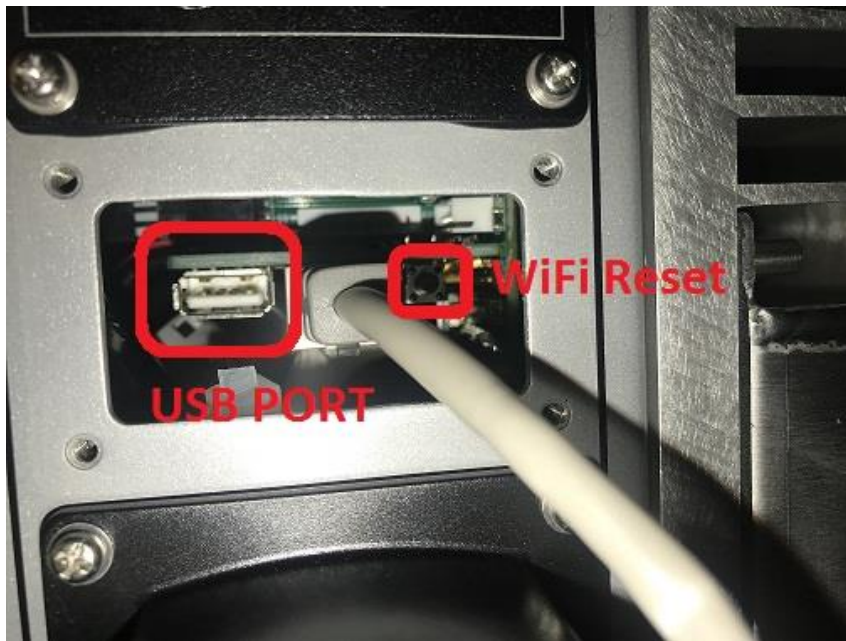

GoodWe ES



GoodWe EM



## Step 3: Main update

### Update tool

1. Open the EzFlash application
2. Tick the box marked ARM
3. Click connect to test inverter connection

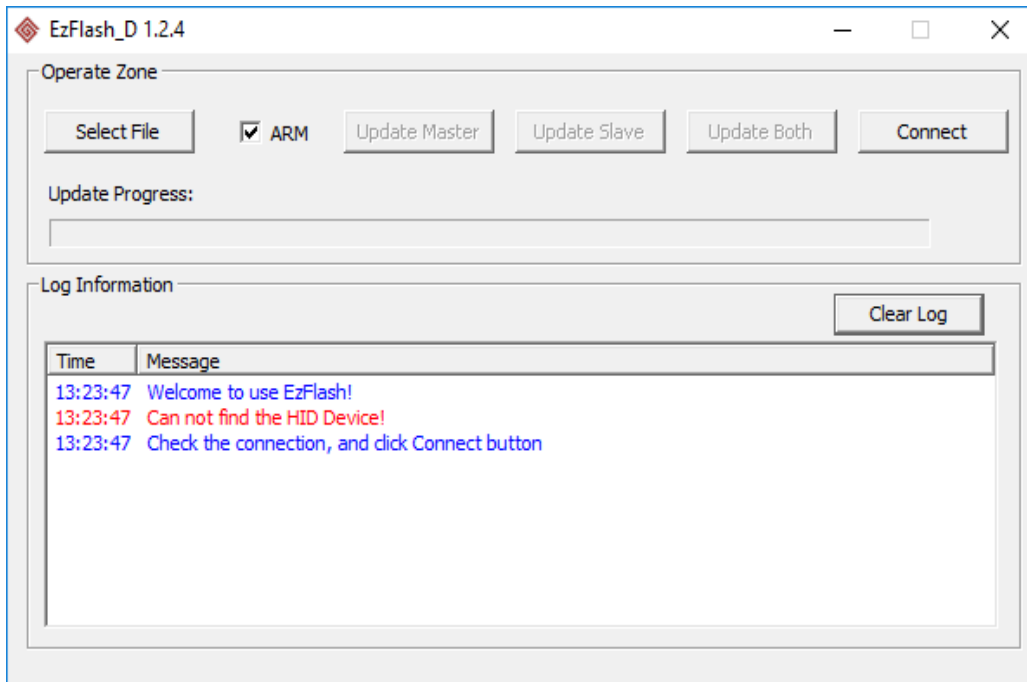

## Step 3: Main update

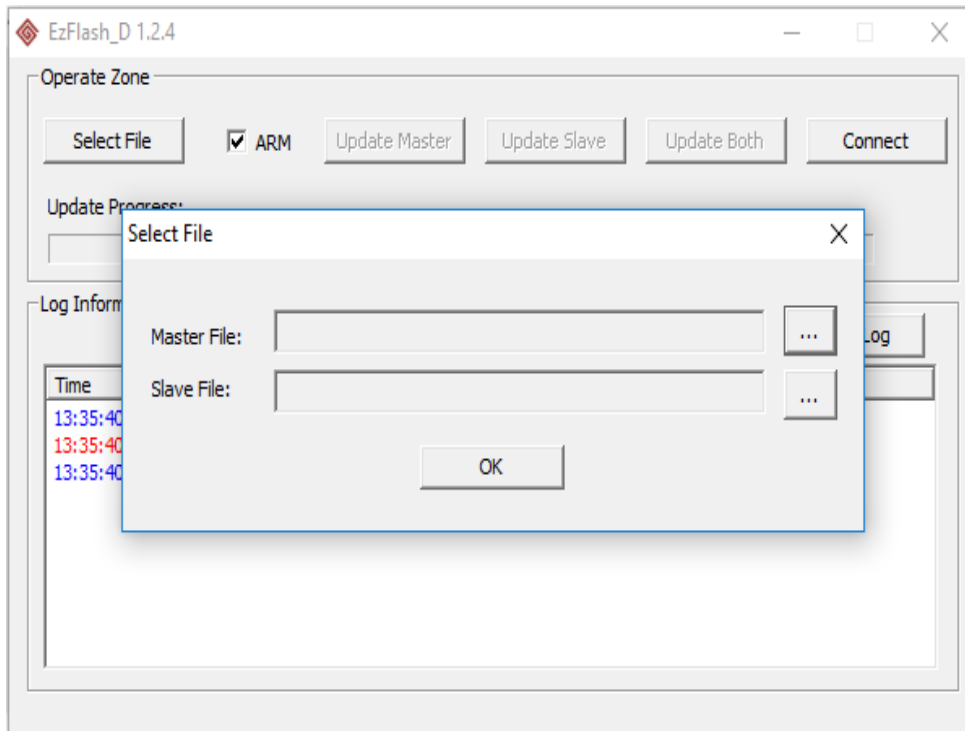

## Update tool

1. Select the slave and master files.
2. Click the update both button

## Step 3: Main update

Time	Message
10:08:54	Slave cpu update in progress...
10:09:06	Erase Start!
10:09:13	Erase End!
10:09:13	Programming in progress ,DO NOT interrupt it!
10:09:21	Programming complete,start verify!
10:09:29	Verify complete!
10:09:29	Slave cpu update successfully!
10:09:29	Reset complete!

### Update tool

1. Wait for update to complete, it takes about 5 min.

## Step 4: Open the software tool

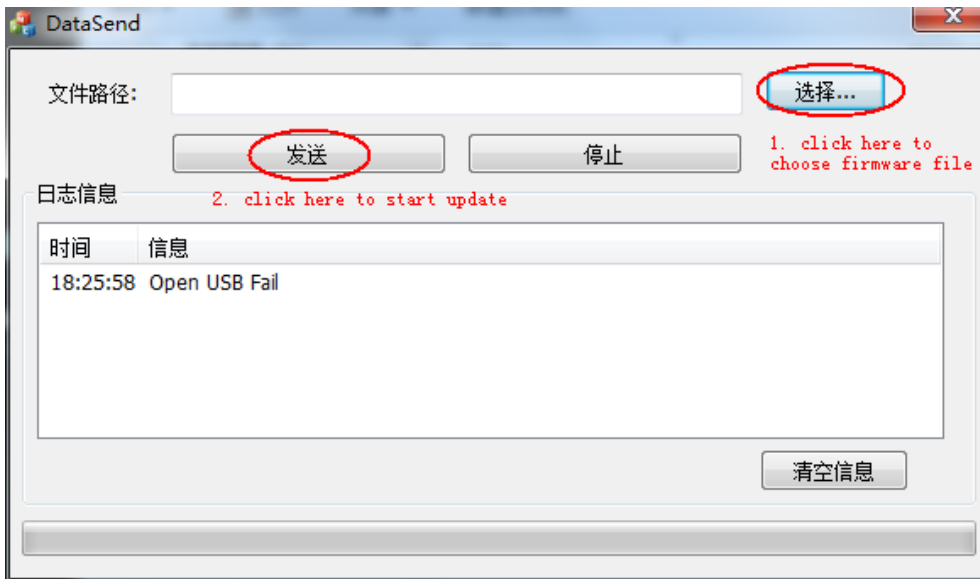

## Update tool

1. Open the email and save the DataSend tool and the .bin file to your computer
2. Open the DataSend tool.
3. Click on the first button indicated and select the .bin file saved on your computer.
4. Click on the second button indicated and wait for the application to display that its completed.

## Updating WiFi Firmware

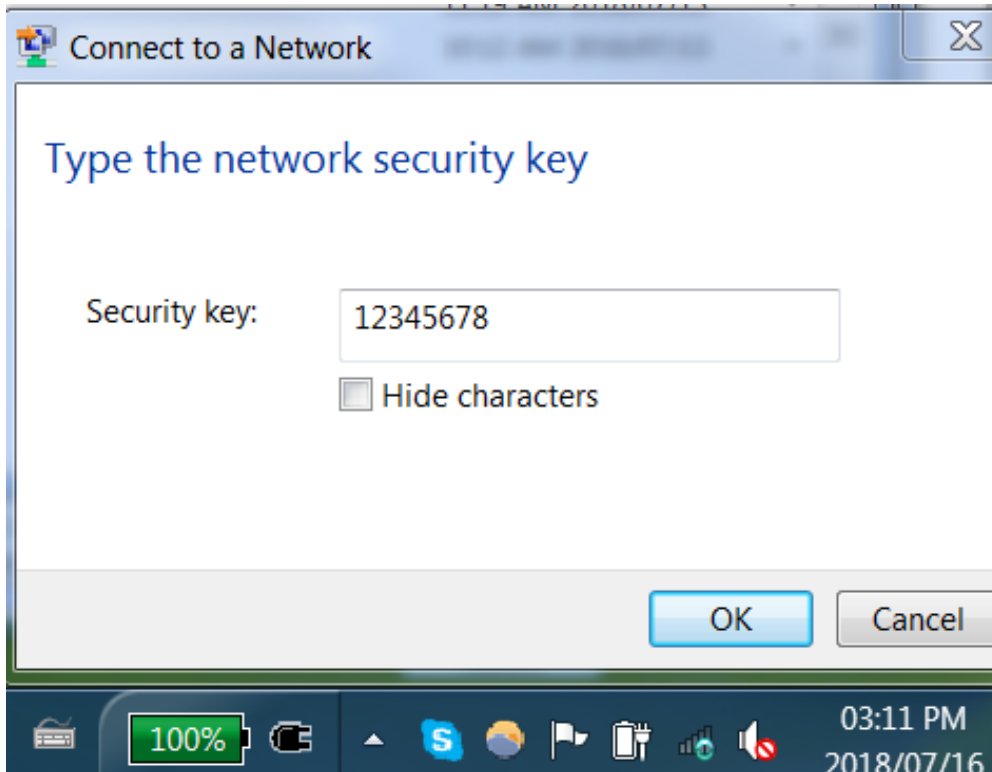

Connect to SolarWiFi and enter the security key

10.10.100.253/index\_en.html

Segen Activities SegenSolar Pty Prod Segen Warehouse

中文 | English

Wizard  
Advanced  
Management

### Device information

Firmware version	V1.0.3
MAC address	F0FE6B927276
Wireless AP mode	<b>Enable</b>
SSID	Solar-WiFi18100018
IP address	10.10.100.253
Wireless STA mode	<b>Enable</b>
Router SSID	WiFi_Burn-in2
Encryption method	WPA2PSK
Encryption algorithm	AES
Router Password	WiFi_Burn-in

### Cannot join the network, maybe caused by:

router doesn't exist, or signal is too weak, or password is incorrect.

★**Help:** Wizard will help you to complete setting within one minute.

[Start Setup](#)

## Browser UI

Enter IP address into the browser  
10.10.100.253

Wizard  
Advanced  
Management  
1.

### Restart device

★**Important:** After restart ,config will take effect.  
It is recommended to restart after completing all configurations.  
Restart will interrupt the network for a very short period.  
Are you sure to restart now?

OK

### Restore factory setting

★**Important:** After restoring factory settings, all user's configuration will be deleted.  
You can reconfigure it on <http://10.10.100.253>.  
Account and password are both "admin".  
Are you sure to restore now?

OK

### Upgrade Software

Current version: V1.0.2 2.

Firmware file: Choose File No file chosen

Upload  
3.  
4.

1. Click on Management
2. Check the current version
3. Select the firmware file
4. Click on upload and wait for the process to complete





## GoodWe EM WiFi Reset

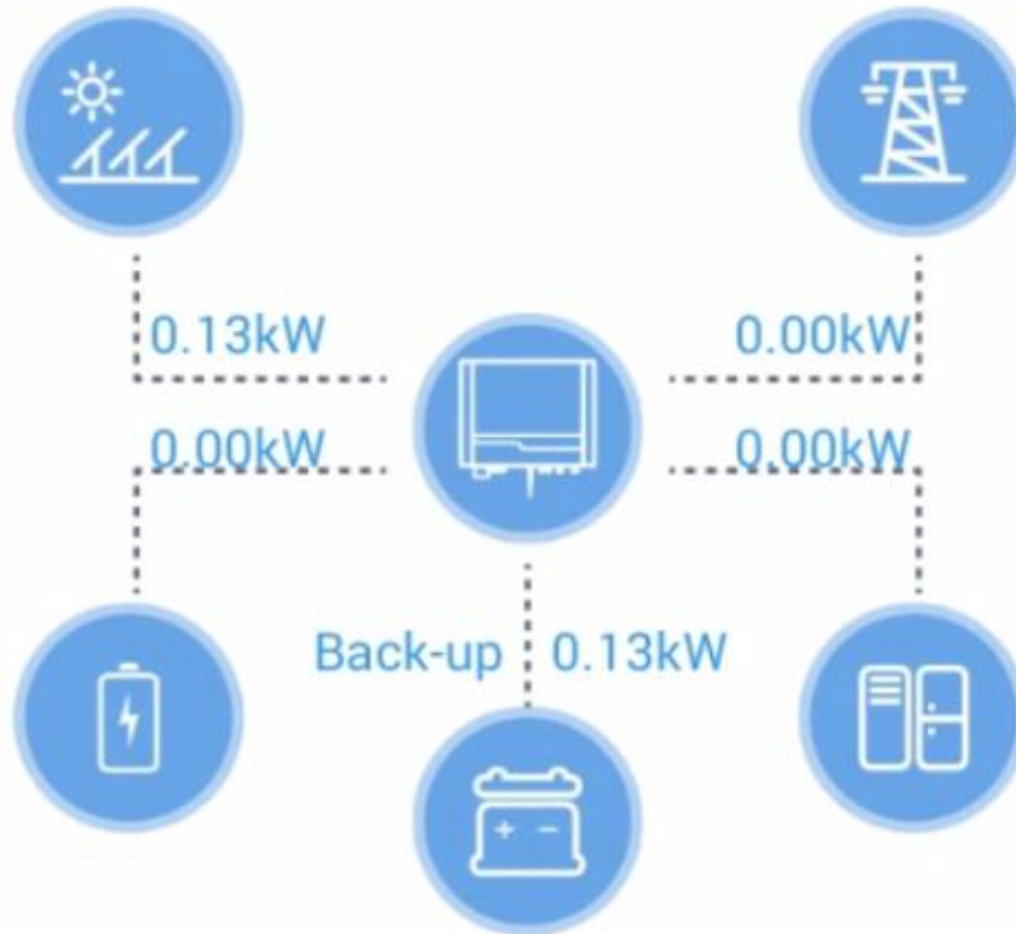

## Commission the inverter

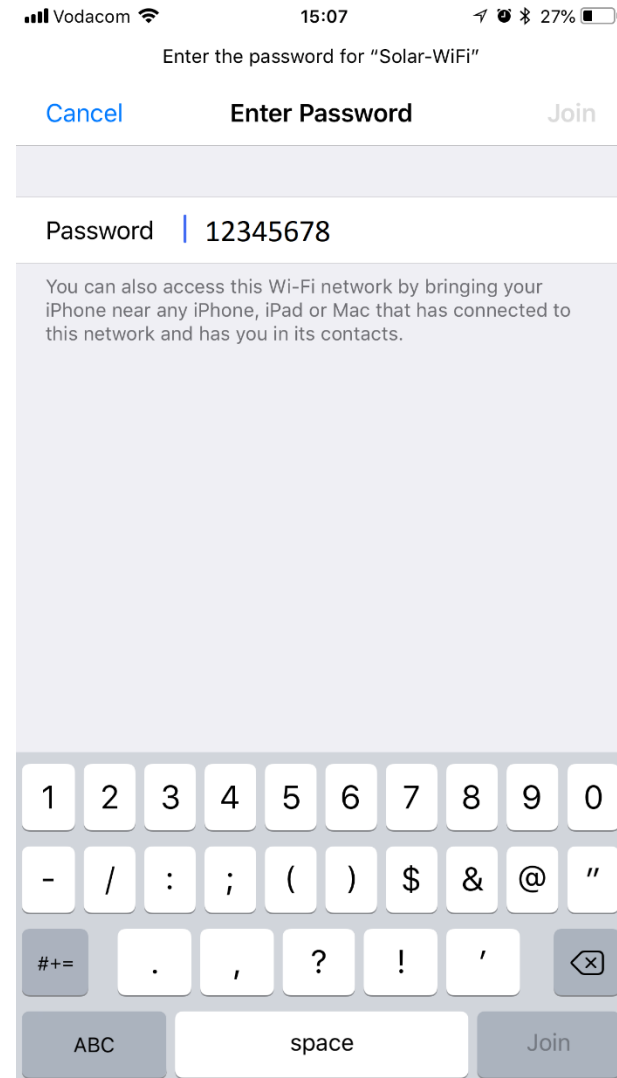
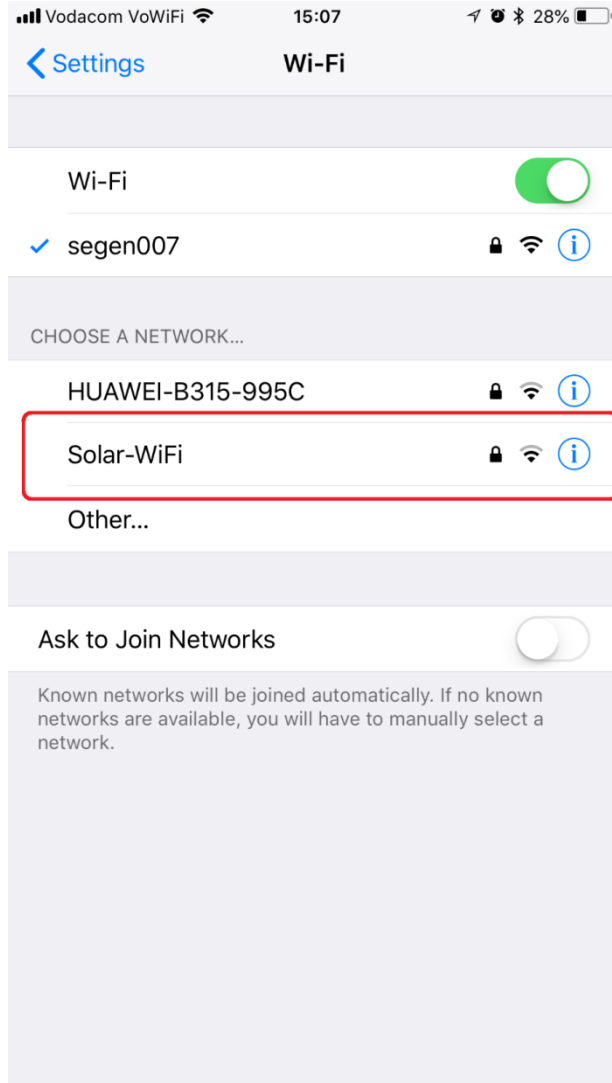





**GOODWE**  
your solar engine

Primary Server ▼

Fill in Phone/User name/Email

Password

Remember [Forgot Password?](#)

Login

New Registration

WiFi Configure

**Local Configuration**

Copyright2017 © GoodWe V3.0.8

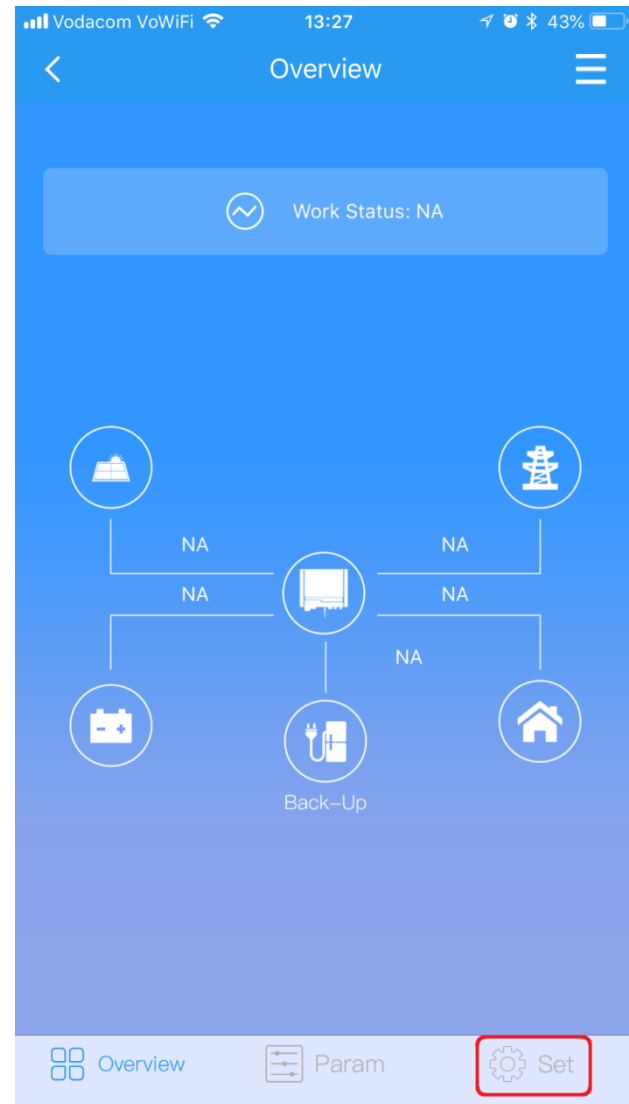

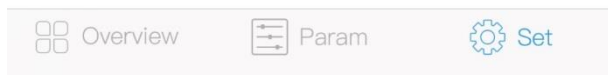
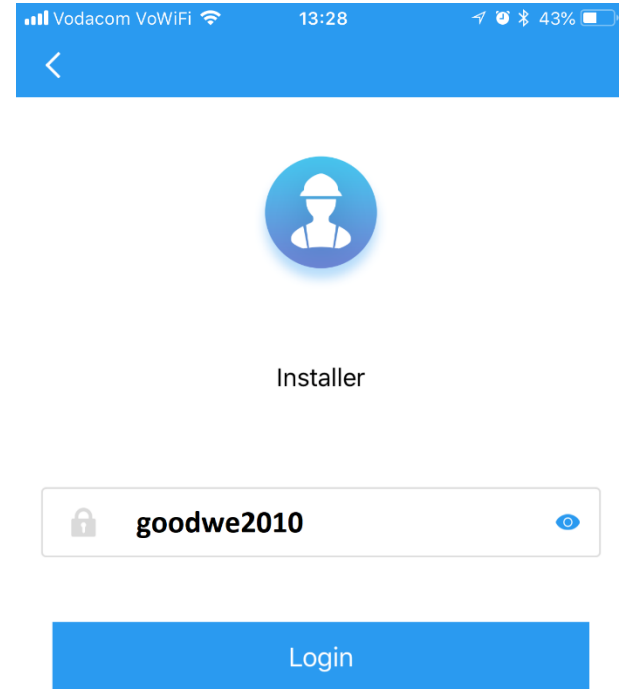
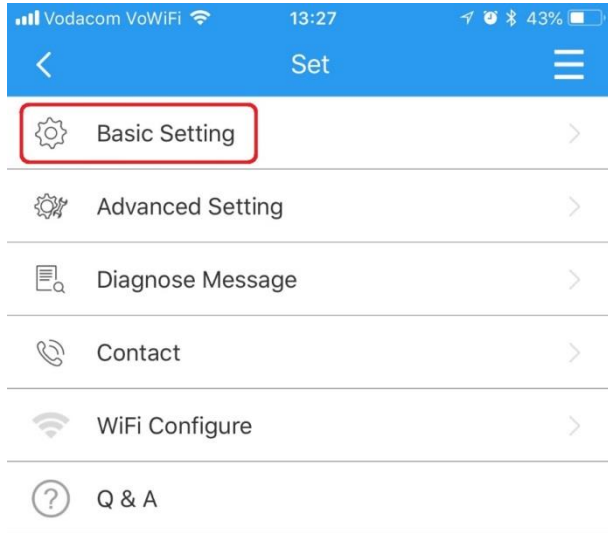

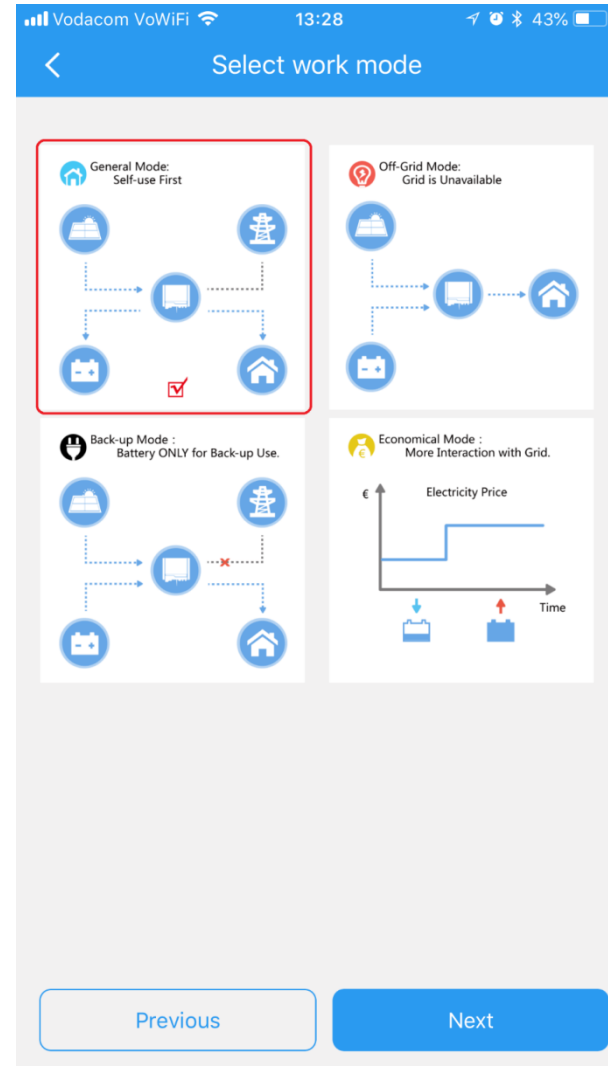

Vodacom VoWiFi 13:29 43%

Select Battery Model

- LG
- PYLON
  - PYLON US2000A
  - PYLON US2000B\*1
  - PYLON US2000B\*2
  - PYLON US2000B\*3
  - PYLON US2000B\*4
  - PYLON US2000Plus\*1
  - PYLON US2000Plus\*2
  - PYLON US2000Plus\*3
  - PYLON US2000Plus\*4
- ALPHA

Previous Start

Vodacom VoWiFi 13:29 43%

Select Battery Model

- BYD
  - Battery-Box Pro/Res 2.5
  - Battery-Box Pro/Res 5.0
  - Battery-Box Pro/Res 7.5+
  - Battery-Box Pro 16.5
  - Battery-Box L 3.5
  - Battery-Box L 7.0+
- GCL
- LG
- PYLON
- ALPHA
- HOPPECKE

Previous Start

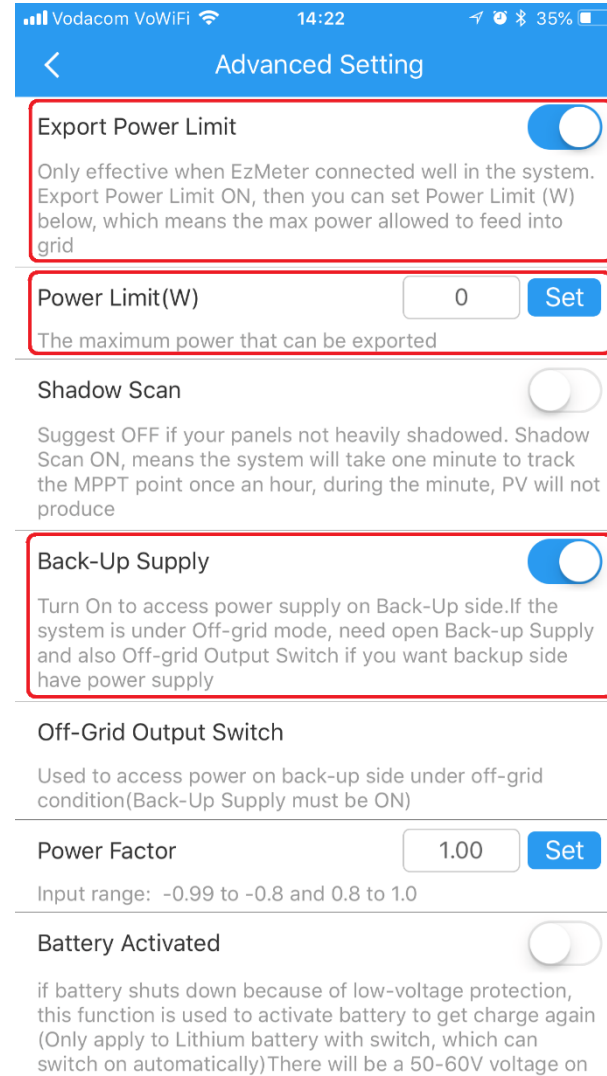
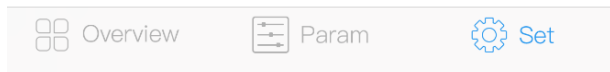
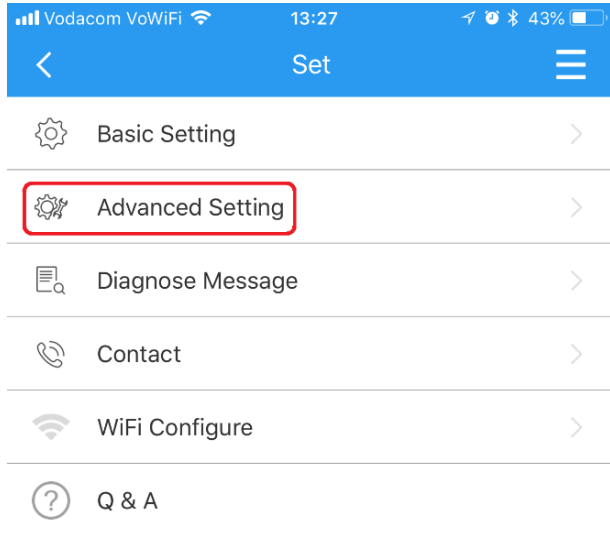

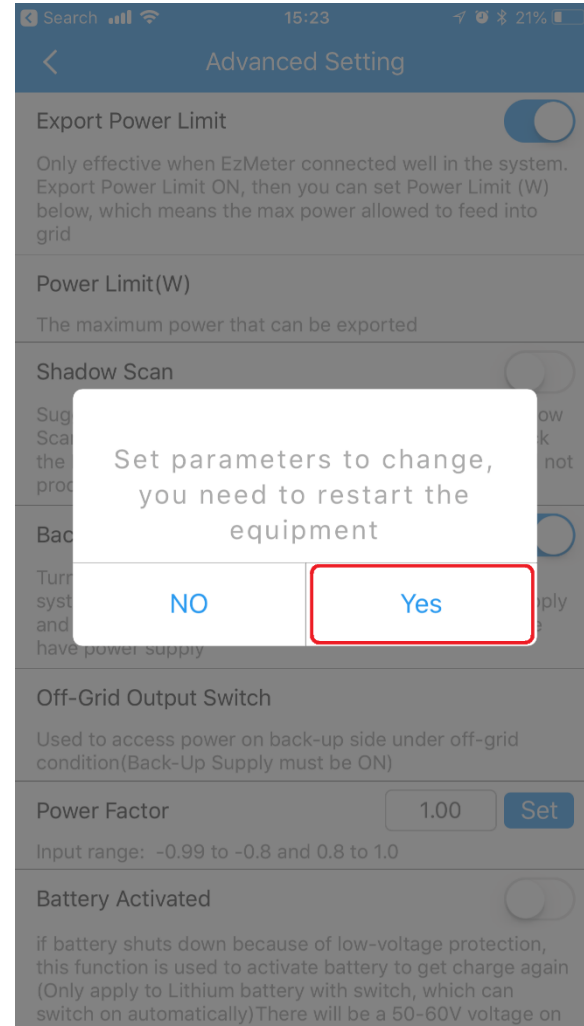
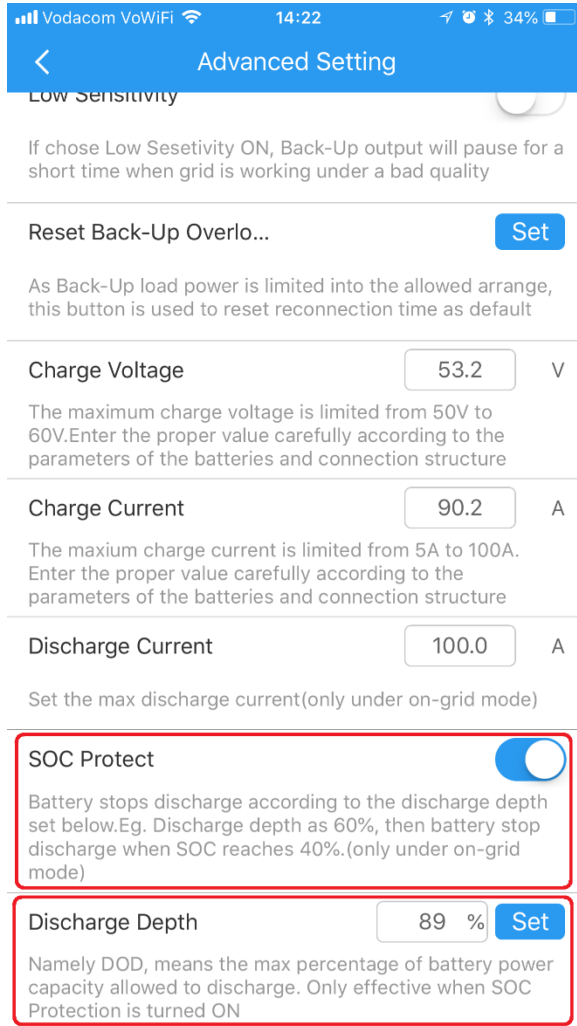



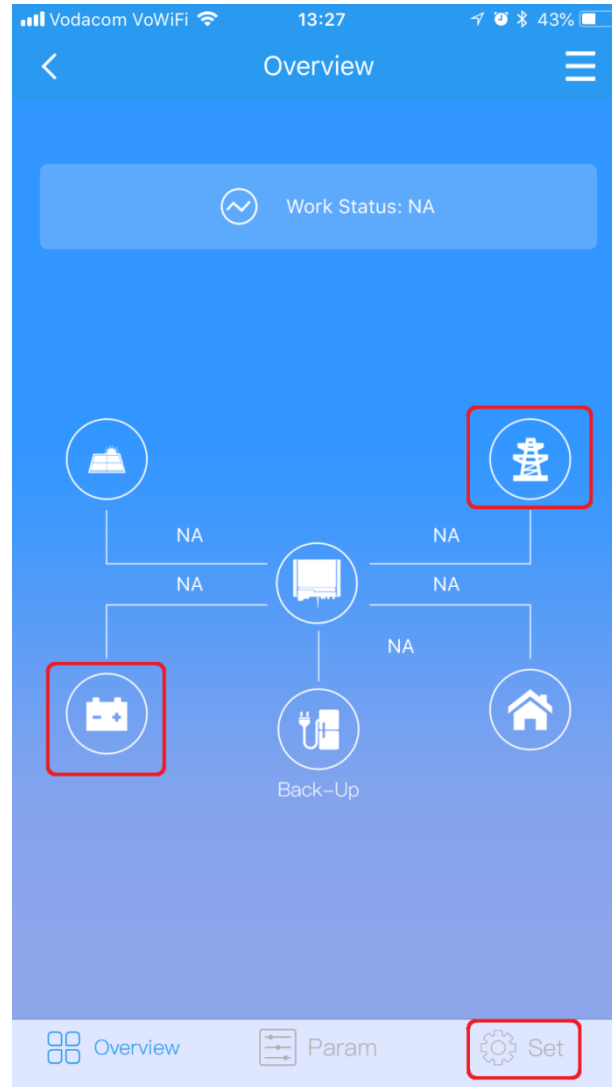

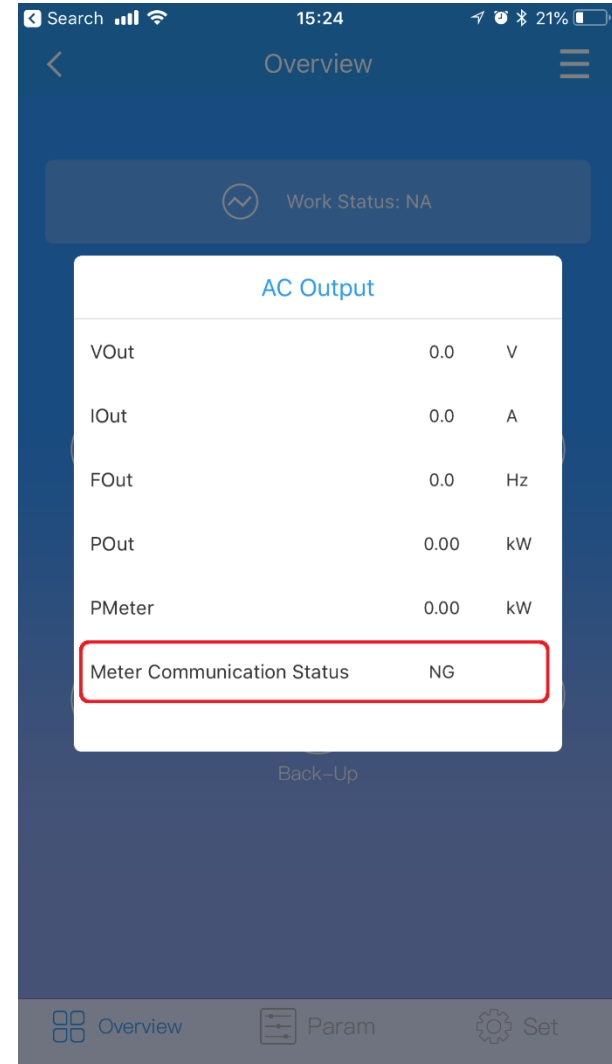
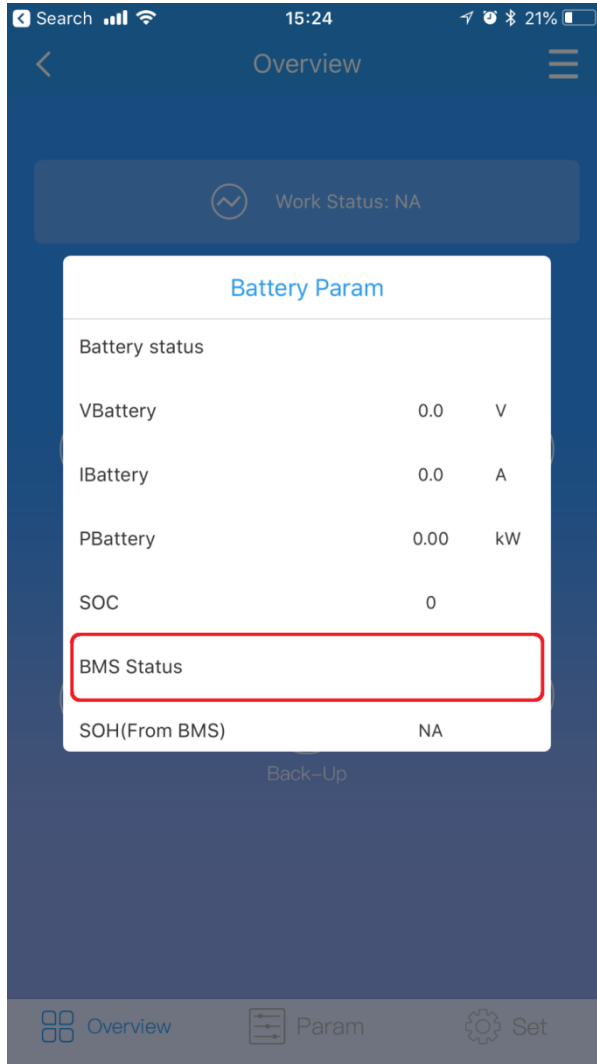

## Sizing a Goodwe inverter

### Choosing inverter size

- Back up-capacity requirements 2.3kVA or 4.6kVA?
- 2.3kVA suitable for smaller loads: lights, electronics, gate and electric fence.
- 4.6kVA suitable for larger loads: fridge, microwave, salt aquarium ect.
- PV generation capacity will be based on daily usage of the site.
- 3kVA, 3.6kVA and 5kVA capacity available to suit different needs.
- The ES inverter may initially seem like a better choice because of the larger back-up supply, however more batteries would be required VS the EM range.

## Sizing a Goodwe and Pylon system

### Sizing the battery bank

- The Goodwe inverter does not make use of the overload capability of the Pylon battery.
- The inverter will turn off the back-up circuit should the battery bank nominal current be exceeded.
- For the US2000B this current is 25A per battery, 37A for the US3000B.
- For the 4.6kVA ES inverter, a minimum of four US2000B or three US3000B units would be needed to get the rated AC output.
- For the 2.3kVA only 2 US2000B are needed to reach the max output.
- Pylon units can be discharged to 89% of their rated nominal capacity.
- When designing a bank, remember to include losses from the inverter and cables.

As can be seen you need twice the battery bank size to run the ES to full capacity. If cost is a concern it may be better to use a EM inverter and have only critical back-up loads.

## Sizing a Goodwe and BYD system

- BYD units have a larger discharge current of 50A
- For a EM inverter, only one 2.4kWH battery would be needed
- For a ES a minimum of 2 are needed.
- BYD may be a better option for the ES inverter as only two units are needed.

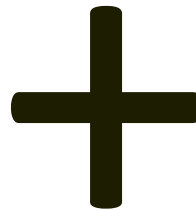

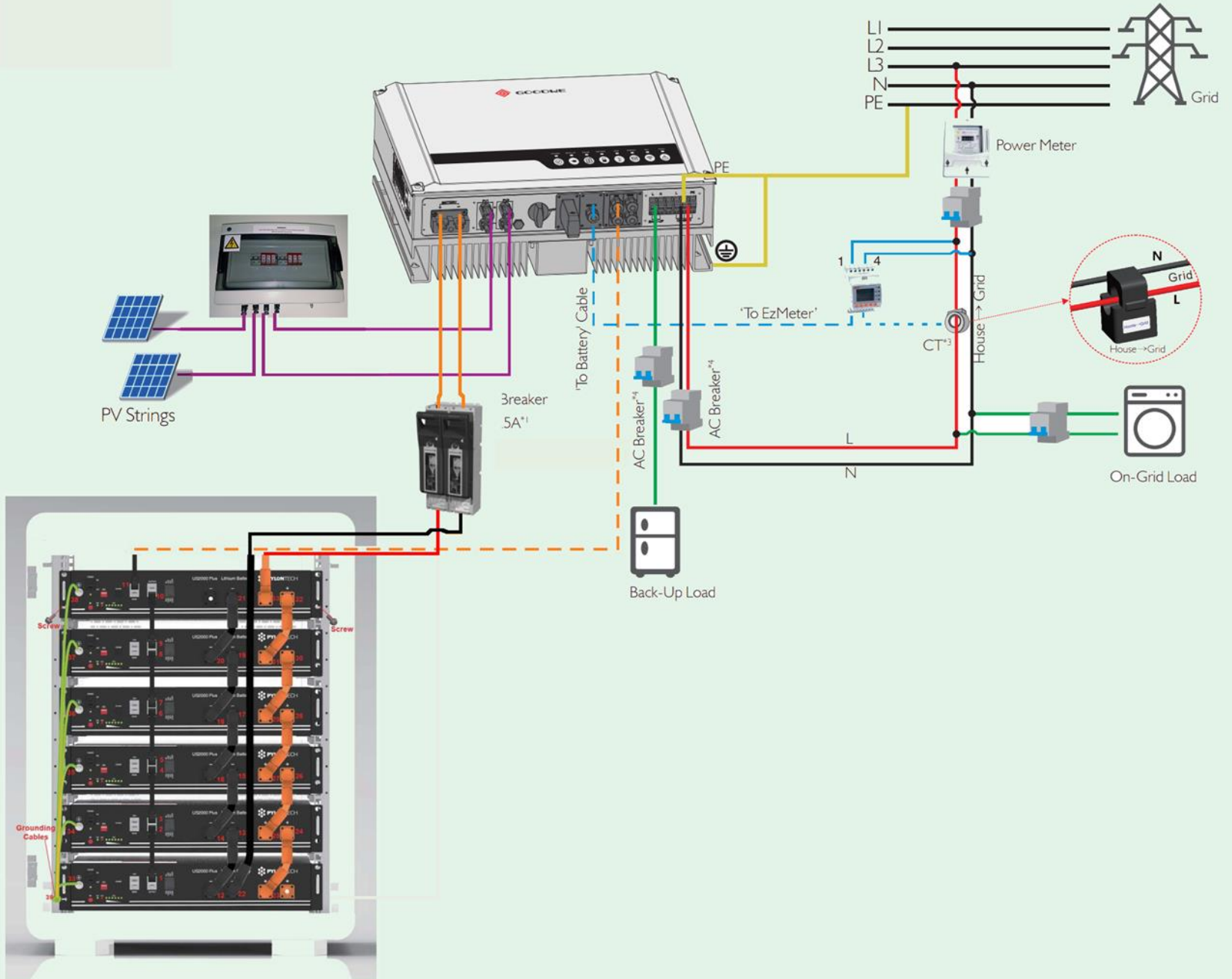

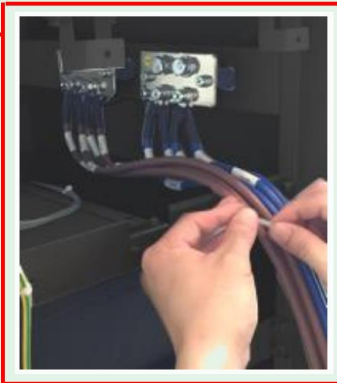
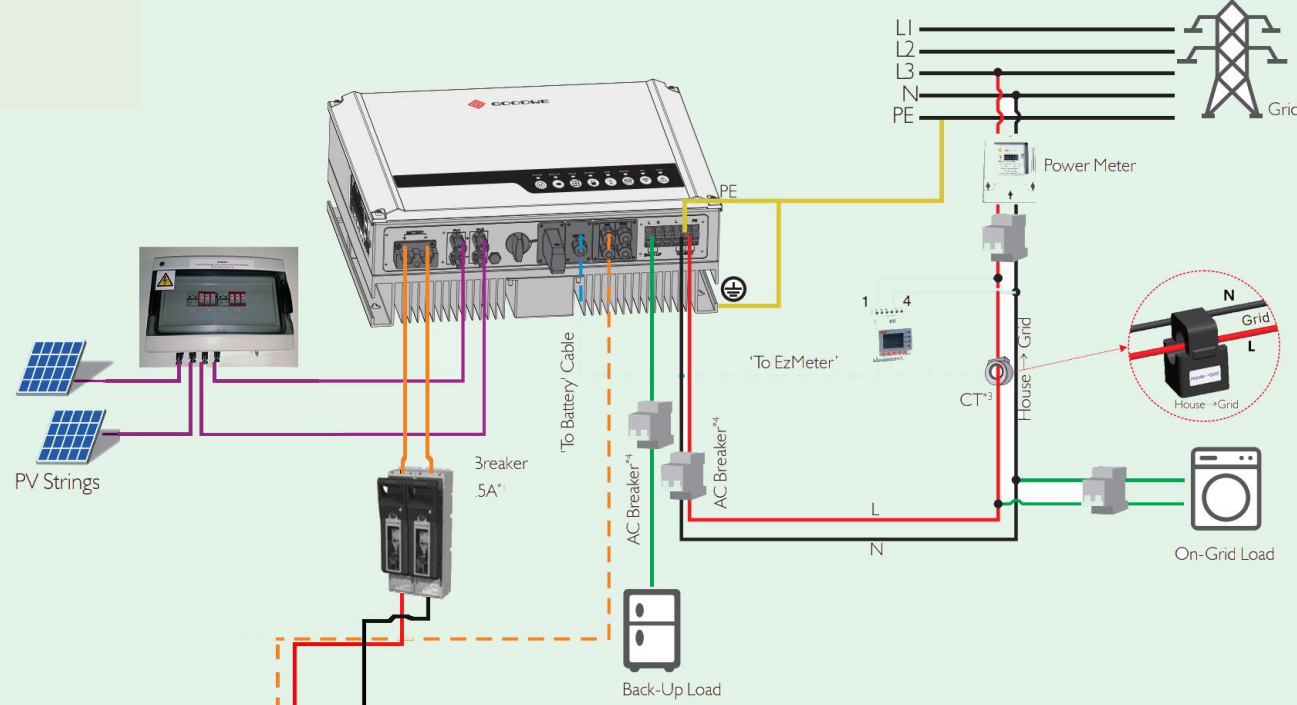

## Trouble shooting common issues

### Unit reading export even though export is disabled.

- Check CT direction
- Check meter communication

### Unit not communicating to batteries.

- Check cable, must be plugged into CAN port
- Check addressing switches
- Check settings for correct battery selection

### PV Master not connecting or getting setup failed message.

- Ensure WiFi dongle firmware is latest version
- Ensure PV master is latest version

### Unit not connecting to WiFi, Sems portal showing “offline”

- Inverter firmware and WiFi firmware should be updated with latest version



## System Monitoring

← → ↻ ⓘ Not secure | hk.semsportal.com/Home/Login



Apps



Demo | Operation Guide | What's new? | GDPR Contacts | Language: English

### Rich Common Reports

Flexible range selection: Plants, locations or organizations

Free time dimension: Monthly, annual or user-defined

Generate reports quickly to meet your needs

kylejoubert@segensolar.co.za

\*\*\*\*\*

Log In Register

Remember me [Forgot Password](#)



<http://www.goodwe-power.com/>

# Monitoring Platform



## Station Overview

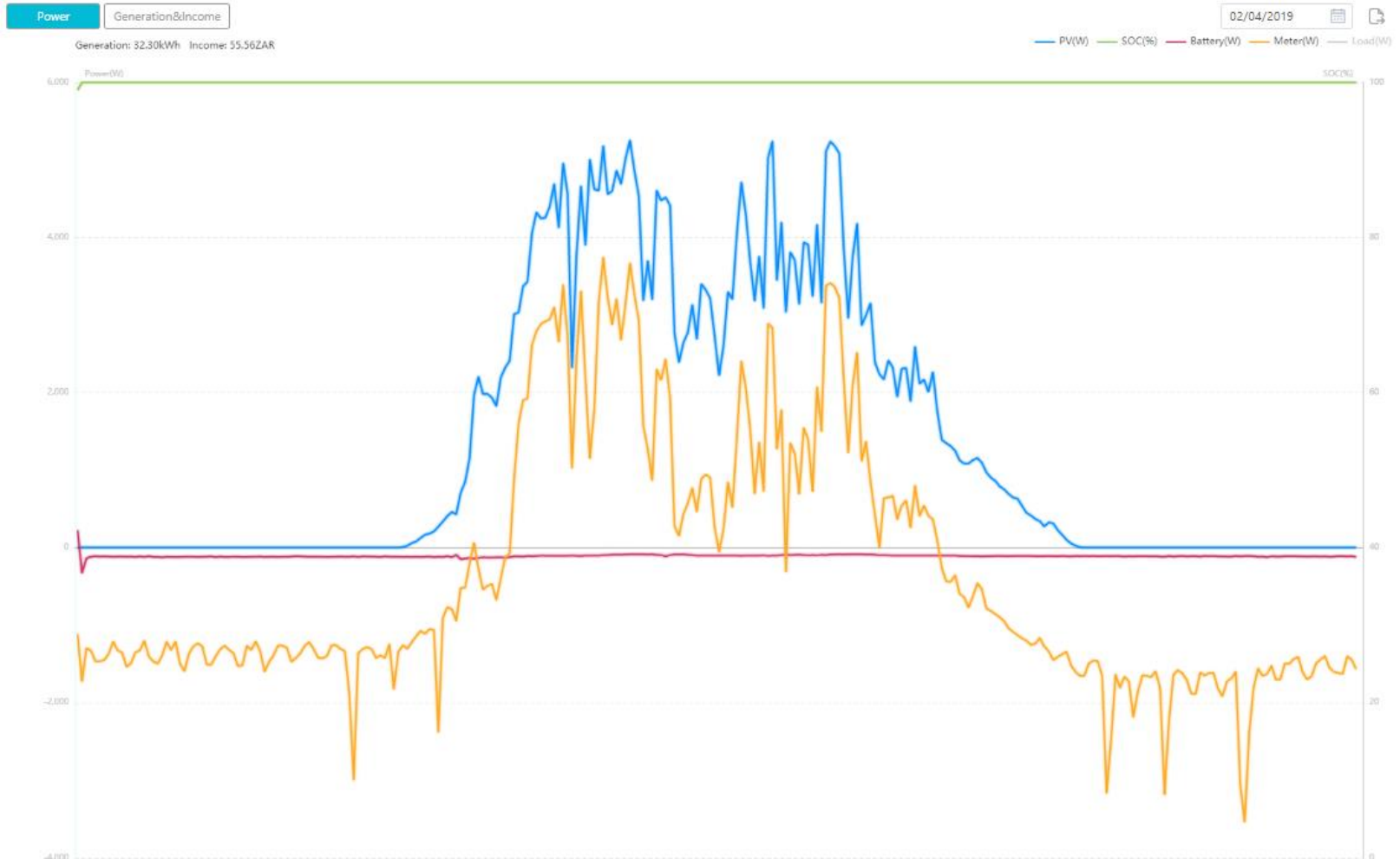

## Register an Account

Select End User and complete the form.

Visitors will need to create an End User account

Log In

Register

Remember

[Forget Password](#)

End user [Need a company account?](#)

\* E-mail

\* Password

\* Confirm

Should be 8-16 characters, include at least one letter and one number.

I'm an adult, I have read and agree "GOODWE User Terms" and "GOODWE Data Protection Claims"

Cancel

Register

With \* is required

Scan the QR code to download App: SEMS Portal



iOS



Android

Website Record Number:16050124-1,Su ICP

# Add a Station

## Station

1. Go into Plant Setup and add owner email

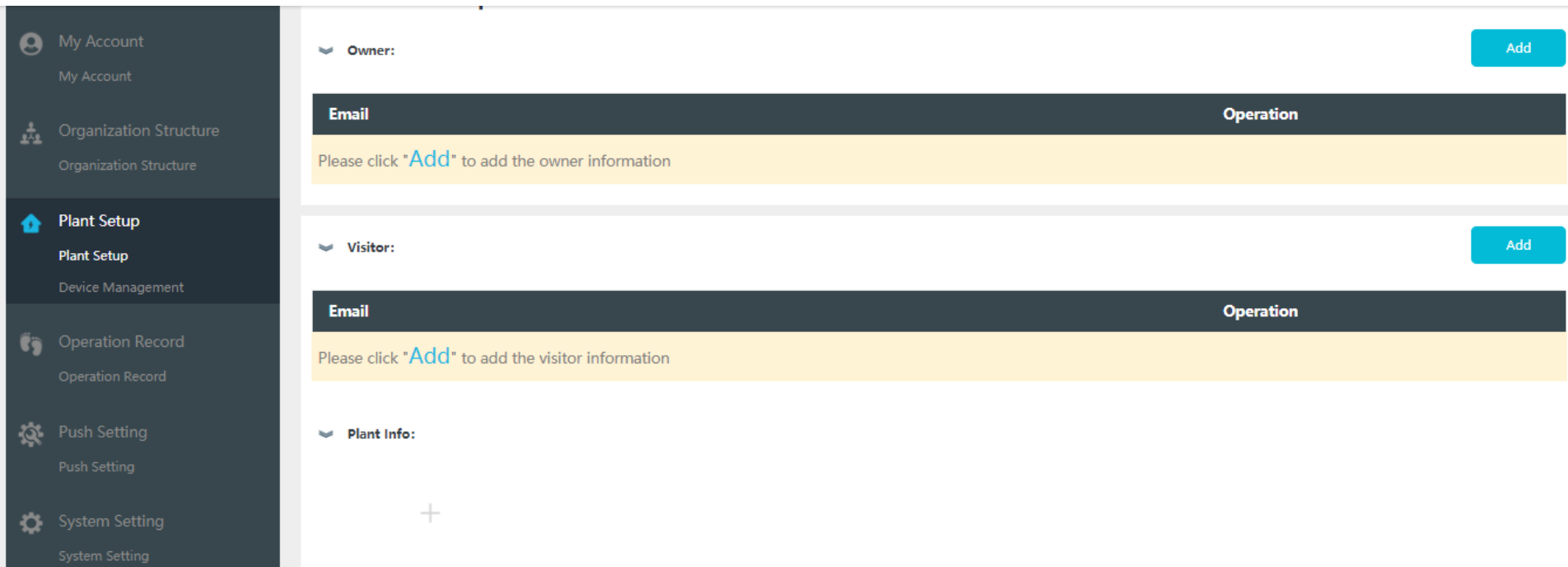

The screenshot displays the 'Plant Setup' interface. On the left is a dark sidebar with navigation options: My Account, Organization Structure, Plant Setup (highlighted), Operation Record, Push Setting, and System Setting. The main content area is divided into three sections:

- Owner:** Features a table with columns 'Email' and 'Operation'. Below the table is a yellow message: 'Please click "Add" to add the owner information'. An 'Add' button is in the top right.
- Visitor:** Features a table with columns 'Email' and 'Operation'. Below the table is a yellow message: 'Please click "Add" to add the visitor information'. An 'Add' button is in the top right.
- Plant Info:** Shows a plus sign (+) for adding information.

## Add a Station

### Station

1. Continue and complete the details, click submit
2. The system will then prompt to add a inverter to the plant

Plant Setup

Plant Setup

Device Management

Operation Record

Operation Record

Push Setting

Push Setting

System Setting

System Setting

+

\*Plant

Creation Date

\*Capacity  kW

Classification

\*Location

Longitude

Latitude

Detailed Address

Distributor code   
Keep it empty if you don't know the installer's code

\*Profit Ratio

\*Battery Capacity  kWh

Amount of solar panles

## Add an Inverter

The **Serial Number** and **Check Code** will be required to register an inverter.

The **Serial Number** and **Check Code** can be found on the inverter name plate.

### New Inverter

Inverter

S/N

Checkcode

# APP Monitoring



Primary Server

Fill in Phone/User name/Email

Password

Remember

[Forgot Password?](#)

Login

[New Registration](#)

WiFi Configure

[Local Configuration](#)

Copyright2017 © GoodWe V3.0.8

Search 08:55 94%

All Stations

KW/KWp ↑ EqHour ↑ EDay ↑ More ▾

Search

Normal	Site Name	KW/KWp:	Power:
		0.00KW	0.22KW
		EDay: 0.60kWh	ETotal: 2588.00kWh
		EquivalentHour: 0.00Hour	CreateTime: 2017-07-10
Normal	Site Name	KW/KWp:	Power:
		0.00KW	0.23KW
		EDay: 1.90kWh	ETotal: 1864.00kWh
		EquivalentHour: 0.00Hour	CreateTime: 2017-08-25
Normal	Site Name	KW/KWp:	Power:
		0.00KW	1.02KW
		EDay: 2.50kWh	ETotal: 2790.50kWh
		EquivalentHour: 0.00Hour	CreateTime: 2017-05-31

All Stations Location Wi-Fi Configure Me



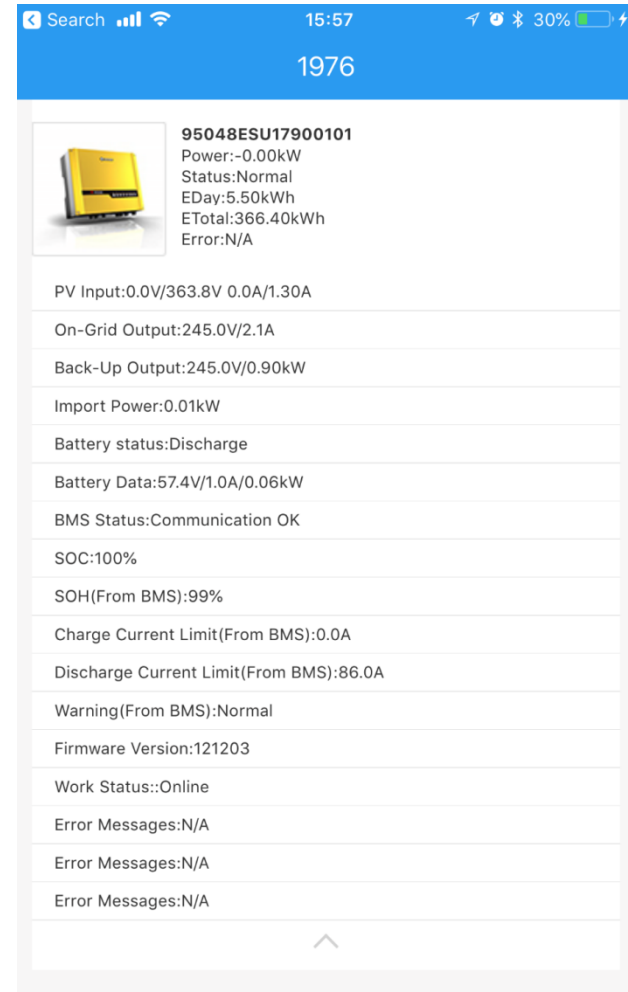
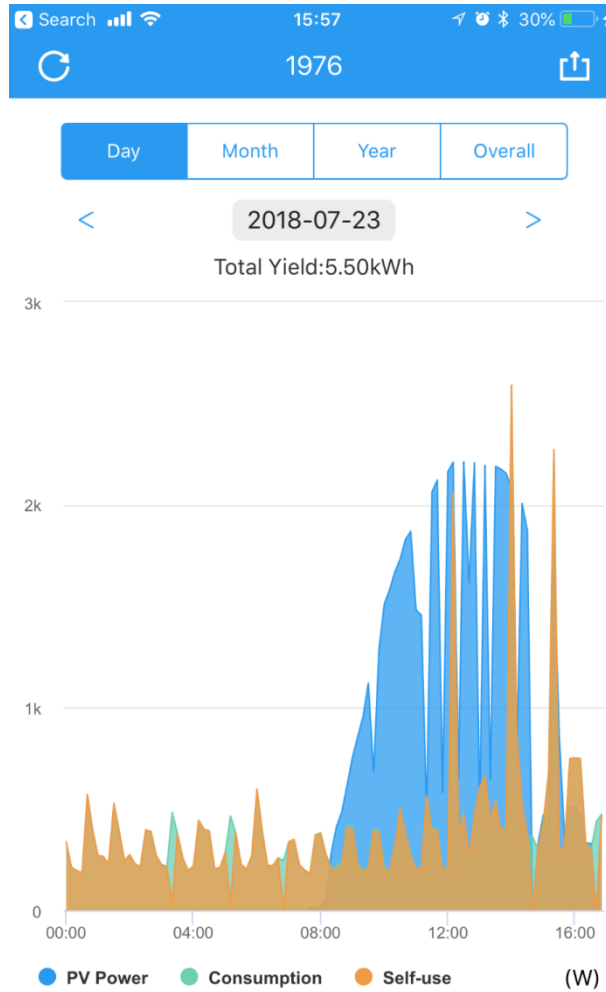

## Installer Accounts

- Contact SegenSolar for a installer account
- Installer can view all connected installations

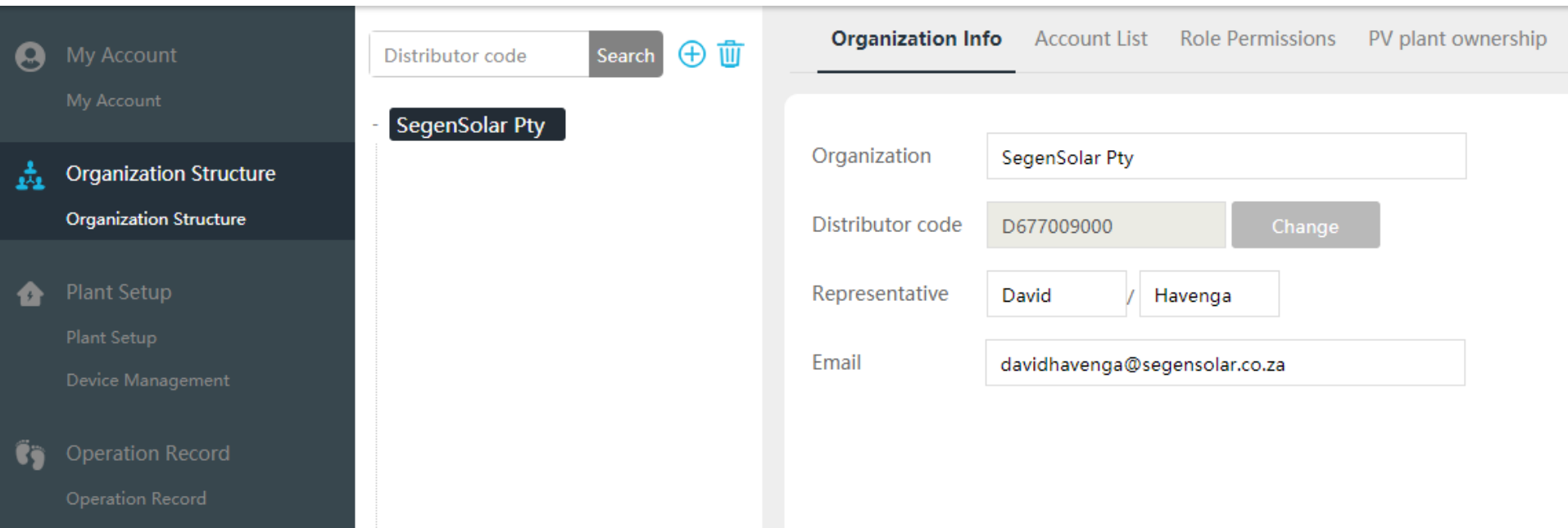

The screenshot displays the SegenSolar installer account management interface. On the left is a dark sidebar with navigation options: My Account, Organization Structure, Plant Setup, and Operation Record. The main content area is divided into two sections. The top section features a search bar for 'Distributor code' with a search button and icons for adding and deleting items. Below this, a dropdown menu shows 'SegenSolar Pty'. The bottom section, titled 'Organization Info', contains a form with the following fields: Organization (SegenSolar Pty), Distributor code (D677009000) with a 'Change' button, Representative (David / Havenga), and Email (davidhavenga@segensolar.co.za). The top right of the main area has tabs for 'Organization Info', 'Account List', 'Role Permissions', and 'PV plant ownership'.

## Pylon Application Note and Documents

Specification

Other Parts

Availability

Documents

Diagnostics

[Application Note Pylon & Axpert/Infinisolar](#)

[CE Declaration of Conformity PylonTech US2000B Plus](#)

[Data Sheet Pylontech ESS US2000B Plus and Phantom S](#)

[Data Sheet SafetyDataSheet Pylon 2.4kWh range](#)

[Installation Manual ESS US2000 Plus](#)

[Installation Manual Pylontech Voltronic Settings](#)

[Product Compatibility Pylon B and B Plus and Phantom](#)

[Safety Transport & Handling Documentation US2000B Phantom](#)

[UN38.3 PylonTech US2000 range](#)

[Warranty ESS US2000 Plus Terms and Conditions SA](#)

[Warranty Pylontech Voltronic Validation form](#)

## Warranty extension



[About Us](#)

[Products](#)

[System Solutions](#)

[Online Store](#)

[Service](#)

[News](#)

[Contact Us](#)

[Sign Up battery](#)

[Complaint Feedback](#)

[Video Training](#)

[Download Document](#)

Your registration will help us to provide you better service. Please carefully fill in the form accurately in details, all the info and the final registration number will be connected to your aftersales service only and will not be disclosure, thank you. You will get another two years warranty after registrate successfully.

\* Your business type:

Distributor

\* Given Name:

\* Family Name:

\* Country:

please choose

\* City:

Address:

<http://www.pylontech.com.cn/service/support>

# Warranty BYD



BYD Lithium Battery Limited Warranty-South Africa

**Warranty Submission**

Applicant	
Company	
Submission date	
Installation date	
Installation address	

**Battery information**

No.	Information needed	Fill in information			
		B-Box 2.5, 5.0, 7.5&10.0kwh		B-Box Pro 12.8&13.8kwh	
1	Serial Number of B-BOX cabinet				
2	Serial number BMS	N/A			
3	Serial Number of battery module	1		1	
		2			
		3			
		4		2	

**Inverter and displayer information**

1	Brand	
2	Model/Specs	

**System information**

System types (tick the applicable box)				Site photo (Supply a photo of the system on site)
Solar	Grid tie			
Wind	Off grid			
Other	Storage only			
Special notes				
For official use				
Checked by		Date		
Accepted by		Date		

\*Terms and conditions apply (refer to BYD lithium battery limited warranty-South Africa)

Complete form and submit to SegenSolar

[https://portal.segensolar.co.za/reseller/docs/warranty\\_submission\\_ver.3.1\\_20170922.pdf](https://portal.segensolar.co.za/reseller/docs/warranty_submission_ver.3.1_20170922.pdf)

## Product Warranty

### STANDARD WARRANTY

GOODWE NS SS DS DT ES series inverters come standard with a **manufacturer's warranty of 66 months (5.5 years)** from the date of production from JIANGSU GOODWE POWER SUPPLY TECHNOLOGY Co., Ltd (hereinafter referred to as GOODWE).

The accessory products include Antenna, EzConverter, EzMeter and EzLogger come standard with a manufacturer's warranty of 30 months (2.5 years) from the date of manufacturing from GOODWE.

For inverters (GOODWE NS SS DS DT ES series), and the accessory products, the warranty can be extended within 24 months (2 years) from the date of manufacturing. Please obtain the warranty extension price list form GOODWE Sales for further information.



# Thank you!