

Technical Datasheet

TriSole 20°-30°

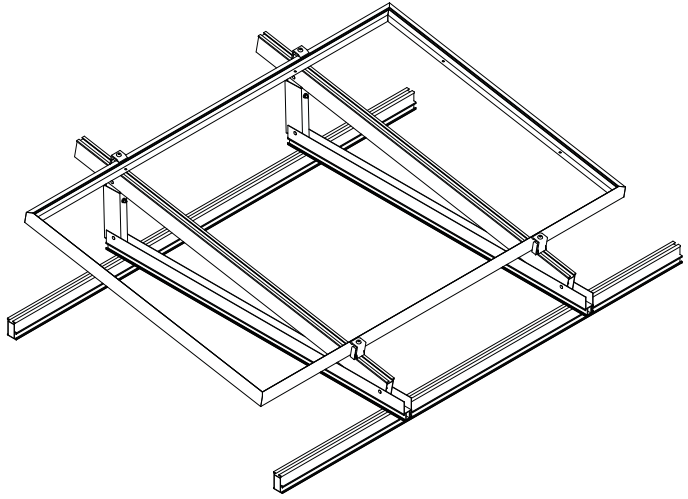

General

System	PV-system for flat roof and ground mounting
Building type	Industrial building, agricultural, residential and for ground mounted system
Roof types	foil, bitumen, trapezoidal sheet, corrugated sheet, corrugated fibre cement, standing seam, concrete, gravel, wooden sub-structures
Material	stainless steel and aluminium
Module pitch	20-30°
Net weight	3,000 kg / piece
Size	1.230-1.308 x 40 x 543-741 (Lenght x Width x Height in mm / per Triangle)
Roof pitch	maximum 20°
Ventilation	fullfilled

Module compatibility

Type	framed PV-Modules and PV-Laminates
Module size (max)	Length unlimited, width limited to 1,000 mm (with rails length and width unlimited)
Module thickness	max. 50 mm
Module guidance	portrait and landscape
Compatibility	Framed modules IEC 61215 / 61646 and IEC61730 certified

Installation

Installation time	54 Minutes per kWp / 8,4 Minutes per m ² modulesurface
-------------------	---

Certifications

TÜV (GER)	yes
-----------	-----

Benefits

Product warranty	10 years
Training	yes / on request
Configuration on-line	in preparation
Support	telephone, Online, on-site